

TOUR

TABLE OF CONTENTS

1 – INTRODUCTION

About this Manual	1-1
Safety Messages Used in this Manual	1-1
Pre-Delivery Inspection	1-2
Front Axle Tire Alignment	1-2
Service and Assistance	1-2
Reporting Safety Defects	1-2
Occupant and Cargo Carrying Capacity Label	1-3
Vehicle Certification Label	1-4
specifications and Capacities	1-5
Owner and Vehicle Information	1-6
2010 New Vehicle Limited Warranty	1-7

2 – SAFETY AND PRECAUTIONS

General Warnings	2-1
Driving Safety	2-1
Fuel and Propane Gas	2-1
LP Gas Leaks	2-2
Propane Gas Leak Detector	2-2
Carbon Monoxide Warning	2-3
Carbon Monoxide Alarm	2-3
Smoke Alarm	2-4
Fire Extinguisher	2-4
Electrical	2-5
Loading	2-5
Maintenance	2-5
Emergency Exits	2-5
Power Sofas and Beds	2-6
Slideout Rooms	2-6
Formaldehyde Information	2-7
Mold, Moisture, and Your Motor Home	2-7
Roof and Ladders	2-8
Roadside Emergency	2-8
Jump Starting	2-9
Engine Overheat	2-10

3 – DRIVING YOUR MOTOR HOME

Seats – Driver/Co-Pilot	3-1
Heated Seats	3-2
Passenger Footrest	3-2
Seat Belts	3-3

Table Of Contents



Child Restraints	3-4
KeyOne™ Lock System	3-5
Power Door Locks	3-5
Mirrors – Power Electric	3-6
Rearview Monitor System	3-8
Rearview Monitor System	3-9
12-Volt Front Drop-Down Solar/Night Shade	3-9
Electronic Compass and Outside Thermometer	3-10
GPS Navigation System	3-10
Parking Brake	3-11
Engine Brake System	3-11
Tag Axle Suspension System	3-12
Hazard Warning Flashers	3-13
Signal Lever/Headlight Hi/Lo Beam	3-13
Map Light Switch	3-13
Steering Column Adjustment	3-14
SmartWheel™ Steering Wheel Control System	3-14
Battery Boost Switch	3-16
Air Conditioner/Heater – Automotive (Dash)	3-17
Defrost Fans	3-17
Radio – In-Dash	3-17
Sirius® Plug and Play Satellite Radio	3-19
CB Radio Power Wiring	3-19
Air Horns	3-20
Fuel Selection – Diesel Engine	3-20
Filling the Fuel Tank – Diesel Engine	3-20
Starting and Stopping Diesel Engine	3-21
Engine Block Heater – Diesel Engine	3-21
Engine Service Access Grille – Rear	3-21
Engine Top Access Covers – Rear	3-22
Engine Top Access Covers – Rear Bath Models	3-24
Fuel/Water Separator – Diesel	3-26
Engine Cooling System	3-26
Chassis Battery Disconnect Switch	3-27
Circuit Breakers and Fuses – Chassis/Dash Automotive 12-Volt	3-27
Front Service Access	3-28
Windshield Washers and Wipers	3-28
Tires	3-29
Suspension Alignment and Tire Balance	3-29
Lights	3-29
Mountain Driving	3-29

4 – APPLIANCES AND SYSTEMS

Refrigerator	4-1
Ice Maker	4-2

Refrigerator Service Access Compartment	4-3
Refrigerator/Freezer - Portable	4-3
Range Top	4-4
Microwave Oven/Range Hood	4-6
OnePlace® Systems Monitor Panel	4-6
Solar Charger Panel	4-8
Energy Management System (EMS)	4-9
Energy Management System (EMS)	4-9
Water Heater - Gas/ Electric	4-10
Pressure-Temperature Relief Valve	4-11
MotorAid Water Heater	4-12
Propane Gas Furnace	4-12
Rear Furnace	4-13
Electronic Thermostat	4-14
Electronic Thermostat - Model 42AD	4-15
Hydronic Heating System	4-17
Furnace-A/C Thermostat Operation Chart	4-21
Heat Pump	4-21
Central Air Conditioner	4-22
Air Conditioner Filter	4-22
Washer/Dryer	4-24
Washer/Dryer - Stackable	4-25
Washer/Dryer - Prep Package	4-26
Dishwasher	4-26
Central Vacuum Cleaner	4-26
5 – PROPANE GAS	
Propane Gas Supply	5-1
Safe Use of the Propane Gas System	5-2
Propane Gas Warnings and Precautions	5-3
Propane Gas Pressure Regulator	5-4
Propane Vaporization in Cold Weather	5-5
6 – ELECTRICAL	
Electrical Cautions	6-1
Electrical System – House 120-Volt AC	6-1
External Power Cord	6-1
Power Cord Reel	6-3
Inverter/Charger Unit – 2000W	6-3
Circuit Breakers – House 120-Volt AC	6-5
Electrical Outlets – House 120-Volt AC	6-5
Ground Fault Circuit Interrupter	6-5
Electrical Generator	6-6
Electrical System – House 12-Volt DC	6-10
Battery Information	6-11
House Battery Disconnect Switch	6-11

Table Of Contents

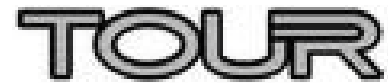

Battery Access	6-11
Battery Care	6-12
Circuit Breakers – House 12-Volt	6-13
7 – PLUMBING	
Fresh Water System	7-1
Water Pump	7-2
Filtered Water Faucet	7-4
Full-Coach Water Filtration System	7-5
Disinfecting Your Fresh Water System	7-6
Shower Hose Vacuum Breaker	7-8
Exterior Shower/Wash Station	7-8
Toilet	7-8
Toilet - Electric Flush	7-8
Waste Water System	7-9
Utility Light	7-11
WaterLine and Tank Drain Valves	7-12
Water Heater Bypass Valve	7-13
Winterizing Procedures	7-13
Winterizing Optional Appliances	7-18
Water System Drain Valve Locations	7-21
8 – ENTERTAINMENT	
High Definition Video Selection System	8-1
Front TV Ignition Switch Interlock	8-2
Audio-Video System Basic Operation	8-2
DVD Home Theater System	8-2
CD/DVD Player - Bedroom	8-3
CD/DVD Player	8-4
TV (Bedroom) - Power Lift	8-5
TV Antenna	8-6
TV Signal Amplifier	8-7
TV Digital Satellite System – Automatic	8-7
TV Digital Satellite Dish – In-Motion	8-8
TV Digital Satellite System Wiring	8-8
Portable Satellite Dish and Cable TV Hook-ups (Input)	8-9
Exterior Entertainment Center	8-9
9 – FURNITURE AND SOFTGOODS	
Lounge Chair Base Clamp	9-1
Table and Chairs	9-1
Sleeping Facilities	9-2
Dinette/Bed Conversion	9-2
Booth Dinette - 40WD Models	9-3
Sofa/Bed Conversion	9-4
Sofa/Bed Conversion	9-4

Rest Easy® Multi-Position Lounge	9-5
Extendable Sectional Sofa	9-7
Theater Seating/Bed Conversion	9-8
Sleep Number® Bed	9-10
Bed - Power Lift	9-10
Day/Night Pleated Blinds	9-10
Roller Shades (Manual) - Solar Day/Night	9-11
Wood Furniture and Cabinetry	9-12
10 – SLIDEOUT ROOMS AND LEVELING	
Slideout Room Travel Locks - Electric	10-1
Slideout Room KeyLock	10-2
Slideout Room Retraction (with Power Lift Bed Option)	10-2
Slideout Room Operation – Hydraulic	10-2
Slideout Room – Extreme Weather Precaution	10-5
Slideout Room Troubleshooting – Hydraulic	10-5
Slideout Emergency Retraction Procedures	10-6
General Slideout Care	10-9
Leveling System	10-10
Checking Hydraulic Oil Level	10-12
11 – MAINTENANCE AND STORAGE	
Sealants – Inspection and General Information	11-1
Roof	11-1
Undercarriage	11-1
Exterior Automotive Paint Finish	11-2
Care of Appliques and Decals	11-4
Front End Masks and Paint Damage	11-4
Headlights and Exterior Lights	11-4
Plastic Parts – Cleaning	11-5
Interior Soft Goods	11-5
Cabinetry – Cleaning	11-6
Solid Surface Countertop – Corian®	11-7
Galley Sink	11-7
Range and Refrigerator	11-8
Bathroom	11-8
Doors and Windows	11-8
Vehicle Storage – Preparation	11-9
Vehicle Storage – Removal	11-9
Chassis Service and Maintenance	11-10
Chassis Fuses and Relays	11-10
Chassis Diagnostic Connectors	11-11
Coach Maintenance Chart	11-12
12 – MISCELLANEOUS	
Loading the Vehicle	12-1

Weighing Your Loaded Vehicle	12-1
Car or Trailer Towing	12-3
Trailer Wiring Connector	12-4
Towing Guidelines	12-4
Fireplace	12-5
Entry Step – Electric	12-6
Stepwell Cover	12-7
Windows	12-8
Power Roof Ventilator – Galley	12-9
Power Roof Ventilator – Bath	12-10
Tool and Ladder Storage	12-11
Roof Ladder	12-11
Storage Compartment Doors	12-12
Power Awning	12-13
Power Awning (Over the Door)	12-14
Air Hose Connector	12-15
Effects of Prolonged Occupancy	12-15

TOUR

SECTION 1 – INTRODUCTION

Congratulations! We welcome you to the exciting world of motor home travel and camping. You will find it convenient and enjoyable to have all the comforts of home and still enjoy the great outdoors wherever you choose to go. Your motor home has been carefully designed, engineered, and manufactured to provide years of enjoyment.

Before sliding into the driver's seat, please become familiar with operations and features. In addition, spend some time with the dealer when you take delivery to learn all you can about your new motor home.

ABOUT THIS MANUAL

This operator's manual was prepared to aid you in the proper care and operation of the vehicle and equipment.

Please read this manual completely to understand how everything in your coach works before taking it on its "maiden voyage".

NOTE: This manual describes many features of your motor home and includes instructions for its safe use.

This manual, including photographs and illustrations, is of a general nature only.

Some equipment and features described or shown in this manual may be optional or unavailable on your model.

Because of Winnebago Industries[®], continuous program of product improvement, it is possible that recent product changes and information may not be included.

The instructions included in this manual are intended as a guide, and in no way extend the responsibilities of Winnebago Industries beyond the standard written warranty as presented in this manual.

The descriptions, illustrations, and specifications in this manual were correct at the time of printing. We reserve the right to change specifications or

design without notice, and without incurring obligation to install the same on products previously manufactured.

The materials in your InfoCase contain warranty information and operating and maintenance instructions for the various appliances and components in your motor home.

NOTE: Many of the instruction sheets and manuals for the various appliances and components have been incorporated into the Operator's Manual Supplement for your convenience.

Please read the FAQ in Section 1 of the Operator's Manual Supplement for more details.

Throughout this manual, frequent reference is made to the vehicle chassis manual that is provided by the manufacturer of the chassis on which this motor home is built.

Consult the chassis manual for operating, safety, and maintenance instructions pertaining to the chassis section of the motor home.

SAFETY MESSAGES USED IN THIS MANUAL

Throughout this manual, certain items are labeled Danger, Warning, Caution, or Note. These terms alert you to precautions that may involve damage to your vehicle or a risk to your personal safety. Read and follow them carefully.



DANGER

DANGER indicates a hazardous situation which, if not avoided, will result in death or serious personal injury.



WARNING

WARNING indicates a hazardous situation which, if not avoided, could result in death or serious personal injury.



CAUTION

CAUTION indicates a hazardous situation which, if not avoided, could result in minor or moderate personal injury.

NOTICE

NOTICE is used to address practices not related to personal injury.

NOTE: A “Note” is not necessarily safety-related, but indicates a recommendation or special point of information that could assist in understanding the use or care of a feature item.

PRE-DELIVERY INSPECTION

This motor home has been thoroughly inspected before shipment. Your dealer is responsible for performing a complete pre-delivery inspection of the chassis and all motor home components.

As a part of the pre-delivery inspection procedure, the dealer is responsible for road testing the motor home, noting, and correcting any problems before delivery.

**FRONT AXLE TIRE
ALIGNMENT**

We recommend that you have the front suspension and steering alignment checked and adjusted after you have fully loaded the vehicle

according to your needs. Thereafter, have alignment inspected periodically to maintain vehicle steering performance and prevent uneven tire wear.

SERVICE AND ASSISTANCE

Your dealer will be glad to provide any additional information you need, as well as answer any questions you might have about operating the equipment in your motor home. When it comes to service, remember that your dealer knows your vehicle best and is interested in your satisfaction. Your dealer will provide quality maintenance and any other assistance that you may require during your ownership of this vehicle.

If you need warranty repairs while traveling, you may take your motor home to any authorized Winnebago Industries® dealership and request their assistance.

See the Motor Home Service Dealer Directory in your InfoCase.

REPORTING SAFETY DEFECTS

If you believe that your vehicle has a defect which could cause a crash or could cause injury or death, you should immediately inform the National Highway Traffic Safety Administration (NHTSA) in addition to notifying Winnebago Industries, Inc.

If NHTSA receives similar complaints, it may open an investigation, and if it finds that a safety defect exists in a group of vehicles, it may order a recall and remedy campaign. However, NHTSA cannot become involved in individual problems between you, your dealer, or Winnebago Industries®.

To contact NHTSA, you may either call the Vehicle Safety Hotline toll-free at:

1-888-327-4236; (TTY: 1-800-424-9153)

or go to their website at <http://www.safercar.gov> or write to:

Administrator, NHTSA
1200 New Jersey Avenue S.E.
Washington, D.C. 20590

You can also obtain other information about motor vehicle safety from the NHTSA website at <http://www.safercar.gov>

OCCUPANT AND CARGO CARRYING CAPACITY LABEL

This label is affixed in the driver's area next to or near the Vehicle Certification Label. It contains vehicle occupant and cargo carrying capacity along with the number of seat belt positions in the vehicle. The label also provides the weight of a full load of water and advises that this weight, along with the tongue weight counts as cargo.

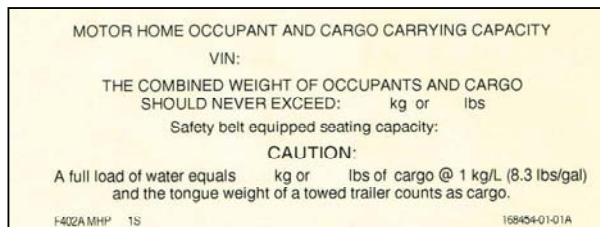

If any weight exceeding 45.4 kg (100 lbs.) is added to your coach between final vehicle certification and first retail sale, the occupant and cargo carrying capacity must be corrected and a label similar to the one shown below will be affixed inside your coach.



VEHICLE CERTIFICATION LABEL

This label is affixed to the lower driver side armrest panel, driver door, or the driver side door jamb, depending on model. It contains vehicle identification numbers and other important reference information.

MANUFACTURED BY WINNEBAGO IND. INC.			3	INCOMPLETE VEHICLE MANUFACTURED BY			1				2						
			GVWR			4			LB			KG					
GAWR:			SUITABLE TIRE AND RIM CHOICE			COLD INFLATION PRESSURE											
FRT			TIRE			RIM			8			PSI			KPA		
5			6			7			8			9					
LB									PSI			KPA					
KG									PSI			KPA					
RR																	
LB																	
KG																	

THIS VEHICLE HAS BEEN COMPLETED IN ACCORDANCE WITH THE PRIOR MANUFACTURER'S IVD, WHERE APPLICABLE. THIS VEHICLE CONFORMS TO ALL APPLICABLE FEDERAL MOTOR VEHICLE SAFETY STANDARDS IN EFFECT ON THE DATE OF MANUFACTURE SHOWN ABOVE.

SERIAL NO.	10	VIN	11	TYPE	12	COLOR	13
XXXXX XXXX XX XX/XX/XX XXX-XXXXX			14	15		XXXXXX-XXX	

EXPLANATION OF DATA

1. Chassis manufacturer.
2. Chassis manufacture date.
3. Month and year of manufacture at Winnebago Industries®.
4. Gross Vehicle Weight Rating: Total permissible weight of the vehicle, including driver, passengers, total cargo carried (including all liquids), and equipped with all options.
5. Gross Axle Weight Rating: Total permissible weight allowed for the front and rear axles (listed in pounds and kilograms).
6. Suitable Tire Choice: Tires recommended to meet handling and safety requirements. When replacing any of the tires on your vehicle, always replace with a tire that meets these specifications.
7. Suitable Rim Choice: Wheel rims recommended to meet handling and safety requirements. When replacing any of the rims on your vehicle, always replace with a rim that meets these specifications.
8. Cold Inflation Pressure: Inflation pressures at Gross Axle Weight Ratings recommended (while cold) for the tires originally equipped on your vehicle. These pressure levels must be maintained to assure proper handling, safety, and fuel economy.
9. Rear Axle Wheel Configuration: Single or Dual as it relates to the inflation.
10. Serial Number: This is the serial number assigned to the completed vehicle by Winnebago Industries.
11. Vehicle Identification Number (VIN): This number identifies the chassis on which the motor home is built. The 10th digit of the VIN designates the chassis model year. (7=2007, 8=2008, etc.). This information is useful when ordering chassis repair parts.
12. Type: States the NHTSA designated usage classification for your motor home. MPV signifies a Multi-purpose Passenger Vehicle.
13. Color: Signifies the color code number of the decor used throughout the vehicle. This number is necessary for ordering replacement cushions, curtains, carpet, etc.
14. Winnebago® model year and series/family name.
15. Model: Lists the Winnebago product model number of your vehicle.

SPECIFICATIONS AND CAPACITIES

Winnebago Tour	40BD	40CD	40WD	42AD
	Freightliner® MAXUM 34,320 lb. Chassis	Freightliner® MAXUM 34,320 lb. Chassis	Freightliner® MAXUM 34,320 lb. Chassis	Freightliner® MAXUM Tag 44,320 lb. Chassis
Feature Number	1LU	1LU	1LU	1LE
Length	40' 7"	40' 7"	40' 7"	42' 10"
Exterior Height ¹	12' 4"	12' 4"	12' 4"	12' 4"
Exterior Width ⁶	8' 5"	8' 5"	8' 5"	8' 5"
Exterior Storage ²	217.9 cu. ft.	217.8 cu. ft.	221.8 cu. ft.	193.0 cu. ft.
Awning Length	15'	18'	15' / 11'	20'
Interior Height	6' 11.7"	6' 11.7"	6' 11.7"	6' 11.7"
Interior Width	8'	8'	8'	8'
Freshwater Capacity ³	90 gal.	90 gal.	90 gal.	90 gal.
Water Heater Capacity	10 gal.	Continuous	10 gal.	Continuous
Optional Water Heater Capacity	10 gal.	NA	10 gal.	NA
Holding Tank Capacity - Black ³	57 gal.	54 gal.	70 gal.	53 gal.
Holding Tank Capacity - Gray ³	94 gal.	117 gal.	54 gal.	105 gal.
LP Capacity ⁴	30 gal.	30 gal.	30 gal.	30 gal.
Fuel Capacity	100 gal.	100 gal.	100 gal.	150 gal.
GCWR ⁵	44,320 lbs.	44,320 lbs.	44,320 lbs.	59,320 lbs.
GVWR	34,320 lbs.	34,320 lbs.	34,320 lbs.	44,320 lbs.
GAWR - Front	14,320 lbs.	14,320 lbs.	14,320 lbs.	14,320 lbs.
GAWR - Rear	20,000 lbs.	20,000 lbs.	20,000 lbs.	30,000 lbs.
Wheelbase	276"	276"	276"	279"

Notes:

All measurements are based upon the most recent data available. See your dealer for specifications.

¹ The height of each model is measured to the top of the tallest standard feature and is based on the curb weight of a typically equipped unit. The actual height of your vehicle may vary by several inches depending on chassis or equipment variations. Contact your dealer for further information.

² The load capacity of your motor home is designated by weight, not by volume, so you cannot necessarily use all available space when loading your motor home.

³ Capacities are based on measurements prior to tank installation. Slight capacity variations can result upon installation.

⁴ Capacities shown are the tank manufacturer's listed water capacity (W.C.). Actual filled propane capacity is 80% of listing due to overfilling prevention device on tank.

⁵ Actual towing capacity is dependent on your particular loading and towing circumstances which includes the GVWR, GAWR, and GCWR as well as adequate trailer brakes. Refer to the chassis operator's manual of your motor home for further towing information.

⁶ Floorplans feature a wide-body design - over 96". You should be aware that some states restrict access on some or all state roads to 96" in body width. You should confirm the road usage laws in the states of interest to you.

OWNER AND VEHICLE INFORMATION

OWNER INFO

Owner's Name(s) _____

Address _____

VEHICLE INFORMATION

Motor Home Model Number _____

Motor Home Serial Number _____

Chassis Vehicle Identification No. (VIN) _____

Vehicle Mileage at Delivery _____

Selling Dealer Name _____

Address _____

YOUR WINNEBAGO INDUSTRIES® DEALER /SERVICE CENTER

Name _____

Address _____

Contact _____ Phone _____

CHASSIS SERVICE CENTER

Name _____

Address _____

Contact _____ Phone _____

RV INSURANCE POLICY

Company _____

Policy Number _____

Agent _____ Phone _____

**2010 NEW VEHICLE LIMITED WARRANTY
WINNEBAGO INDUSTRIES, INC.**
**WARRANTY COVERAGE TO OWNER**

Winnebago Industries, Inc. of Forest City, Iowa, warrants each new Winnebago and Itasca motor home to the owner for recreational use in the U.S.A. and Canada as follows:

BASIC LIMITED WARRANTY**WINNEBAGO INDUSTRIES' RESPONSIBILITY**

Any part of the vehicle subject to this warranty that is found to be defective in material or workmanship under normal use and maintenance will be repaired or replaced at Winnebago Industries' option without charge to the customer for parts or labor upon notice of the defect.

WARRANTY PERIOD

The basic Warranty Period is 12 months or 15,000 miles (24,135 kilometers), on the odometer, whichever occurs first. The Warranty Period for all coverages begins on the date the vehicle is delivered to the first retail purchaser or first placed in service as a demonstrator or company vehicle.

ONLY WARRANTY

This limited warranty is the only warranty made or authorized by Winnebago Industries. Winnebago Industries makes no other promises, representations or warranties concerning the vehicle or other matters set forth herein. Winnebago Industries does not authorize any person to create for it any other obligations or liability in connection with this vehicle.

DEALER'S REPRESENTATIONS EXCLUDED

Winnebago Industries shall not be bound by any undertaking, representation, or warranty made by any dealers selling its product to any purchaser of its products.

EXCLUSIVE REMEDY

THE PERFORMANCE OF REPAIRS IS THE EXCLUSIVE REMEDY UNDER THIS LIMITED WARRANTY OR ANY IMPLIED WARRANTY. ANY IMPLIED WARRANTY OF MERCHANTABILITY OR FITNESS FOR A PARTICULAR PURPOSE APPLICABLE TO THIS VEHICLE ARISING BY WAY OF STATE LAW IS LIMITED IN DURATION TO THE DURATION OF THIS WRITTEN WARRANTY AS HEREINBEFORE OR HEREINAFTER PROVIDED.

LIMITATION ON LIABILITY

WINNEBAGO INDUSTRIES SHALL NOT BE LIABLE FOR INCIDENTAL OR CONSEQUENTIAL DAMAGES RESULTING FROM BREACH OF THIS WRITTEN WARRANTY OR ANY IMPLIED WARRANTY. SUCH DAMAGES INCLUDE, BUT ARE NOT LIMITED TO, LOSS OF TIME, INCONVENIENCE, OR OTHER CONSEQUENTIAL DAMAGE INCLUDING EXPENSE FOR GASOLINE, TELEPHONE, TRAVEL, LODGING, LOSS OR DAMAGE TO PERSONAL PROPERTY, OR LOSS OF REVENUE. Some states do not allow limitations on how long an implied warranty will last or the exclusion or limitation of incidental or consequential damages, so the above limitations or exclusions may not apply to you.

ITEMS NOT SUBJECT TO WARRANTY COVERAGE

Chassis, drivetrain and related components*
Wheels*
Tires*
Any other part or component covered by a written warranty issued by its manufacturer*
Service Items, such as Windshield Wiper Blades, Lubricants, Fluids & Filters
Adjustments
Rust and Corrosion

*These items are covered under the manufacturer's individual warranty.

ADDITIONAL EQUIPMENT NOT COVERED

Winnebago Industries cannot and does not accept any responsibility in connection with any of its motor homes for additional equipment or accessories installed at any dealership or other place of business, or by any other party other than Winnebago Industries. Such installation of equipment or accessories by any other party will not be covered by the terms of this warranty.

36 MONTH/36,000 MILE STRUCTURAL WARRANTY

At the expiration of the Basic Coverage and for the remainder of the period of 36 months or 36,000 miles (57,924 kilometers), on the odometer, whichever occurs first, Winnebago Industries warrants the following:

1. Structural defects of the subfloor, floor, and slide-out room. Floor lamination failure and lamination failure of the subfloor panels and risers are covered by the structural warranty.
2. Body Thermo-Panel® Lamination of the sidewalls and backwall against delamination. Body Thermo-Panel® Lamination is the bonding of the exterior skin and the interior paneling to an insulating core material. Delamination (separation of layers) caused by other factors such as physical damage or failed sealants is not covered by this warranty.

This warranty gives you specific legal rights and you may also have other rights which vary from state to state.

Also, this warranty shall not apply to failures, damage or malfunctions resulting from normal wear, misuse, abuse, negligence, alteration, accident, fire, improper repair of the vehicle or failure to follow recommended maintenance requirements.

OWNER'S RESPONSIBILITY-CARE AND MAINTENANCE

It is the owner's responsibility to perform the care, maintenance and proper load distribution described in the operator's manual which accompanies your motor home. Any damage which results to your vehicle as a result of your failure to perform such duties, is not covered.

Damage to appearance items such as fiberglass, metal, paint, fabrics and trim, may occur during manufacturing or transporting. Normally, any factory defect or damage is corrected at the factory. In addition, dealers are obligated to inspect each vehicle upon delivery to them and prior to delivery to you. You should also immediately inspect appearance items and advise your selling dealer of any discrepancies. Damage and deterioration due to use and exposure, such as rust or corrosion is not covered by this warranty.

OBTAINING WARRANTY REPAIRS

While any Winnebago Industries motor home dealer can perform warranty service, we recommend you return to the dealership that sold you your vehicle. If you are touring or have moved, contact any Winnebago Industries motor home dealer in the United States or Canada for warranty service.

If a part of the system covered by this limited warranty fails to function or requires service during the warranty period:

1. Promptly take the vehicle to the selling dealer for repair or inspection.
2. Written notice of defects must be given to the selling dealer and manufacturer.
3. If the dealer is incapable of making the repairs, request that he contact Winnebago Industries, Inc.
4. If, after the above steps are completed and the repair is not made, the customer should contact Winnebago Industries, Inc., 605 West Crystal Lake Road, P.O. Box 152, Forest City, Iowa 50436, Attention: Owner Relations Department (800-537-1885) and furnish the following information:
 - The complete serial number of the vehicle
 - Date of retail purchase
 - Selling dealer's name
 - Nature of the service problem, and a brief explanation of the steps or service the dealer has performed, and the results obtained. The customer may be directed to another dealer or service center for repairs to be completed, if such a dealer or service center is better able to complete the repair.

Winnebago Industries may, at its option, request the vehicle be returned to Forest City, Iowa for repair. If the customer refuses to allow repairs to be performed at the Forest City, Iowa facility, the warranty on that repair will be voided.

5. If after the above steps are completed and the repairs are not satisfactory, the customer may contact the Service Administration Manager of Winnebago Industries, and request a customer relations board meeting to resolve the problem. This action, however, is not mandatory.
6. Certain components are covered by warranties provided by individual component manufacturers. Please refer to the component's information supplied in the vehicle's InfoCase.

COMMENCEMENT OF ACTIONS

Any action for breach of The Basic Limited or Structural Warranty or any implied warranty shall be commenced within one-year after expiration of the warranty.

CHANGES IN DESIGN

Winnebago Industries, Inc. reserves the right to make changes in design and changes or improvements upon its products without imposing any obligation upon itself to install the same upon its products theretofore manufactured.

NEW YORK:

If your motor home has been repaired three or more times for the same nonconformity, defect, or condition, or if your motor home has been out of service by reason of repair for twenty-one days, Section 198-a of the General Business Law of the State of New York requires you to provide written notice by certified mail, return receipt requested, to Winnebago Industries or its authorized dealer before making any claim under that section of the law. If you do have problems with your motor home, you should provide written notice to Winnebago Industries at the following address:

Winnebago Industries, Inc.
605 West Crystal Lake Road
P.O. Box 152
Forest City, Iowa 50436

Attn: Owner Relations

CALIFORNIA:

Winnebago Industries participates in the Consumer Arbitration Program for Recreation Vehicles (CAP-RV). This third-party dispute resolution program is available, at no charge to you, to settle unresolved warranty disputes for recreational vehicles. This dispute resolution program reviews eligible product and service related complaints involving warranty covered components.

To find out more about the program, or to request an application/brochure, please call the Arbitration Administration office toll-free 800-279-5343.

The CAP-RV program operates as a certified mechanism under the review of the California Arbitration Certification Program. You must utilize the arbitration program before claiming rights conferred by 15 USC section 2310 (Uniform Commercial Code) or Civil Code section 1793.22(b) (Tanner Consumer Protection Act). You are not required to use the program if you choose to seek redress by pursuing rights and remedies not created by those laws.

Members of the Armed Forces who purchased the vehicle in California, or who were stationed in or a resident of California at the time of purchase (regardless of state of purchase) or who are stationed in California at the time of application to this program, may utilize the CAP-RV program.

TOUR

SECTION 2 – SAFETY AND PRECAUTIONS

GENERAL WARNINGS

- Only seats equipped with seat belts are to be occupied while the vehicle is moving.
- Make sure all passengers have seat belts fastened. Lap belts should fit low on the hips and upper thighs. The shoulder belt should be positioned snug over the shoulder.
- For pregnant women, the lap belt should be placed under the abdomen and across the upper thighs. The shoulder belt should be positioned across the center of the chest. Consult your doctor if you have any questions.
- Child restraints should be installed properly according to manufacturer's instructions. See "Child Restraints".
- All moveable or swiveling seats should be placed and locked in position while the vehicle is moving.
- Never let passengers stand or kneel on seats while the vehicle is moving.
- Sleeping facilities are not to be utilized while vehicle is moving.
- Examine the escape window and be familiar with its operation.
- Inspect the fire extinguisher monthly for proper charge and operating condition. This should also be done before beginning a vacation or any extended trip.

DRIVING SAFETY

- Do not attempt to adjust the driver's seat while the vehicle is moving.
- Do not adjust tilt steering in a moving vehicle.
- Do not operate the cruise control on icy or extremely wet roads, winding roads, in heavy traffic, or in any other traffic situation where a constant speed cannot be maintained.

- Use care when accelerating or decelerating on a slippery surface. Abrupt speed changes can cause skidding and loss of control.
- Never drive the vehicle with a slideout room extended.
- Driving through water deep enough to wet the brakes may affect stopping distance or cause the vehicle to pull to one side. Check brake operation in a safe area to be sure they have not been affected. Never operate any vehicle if a difference in braking efficiency is noticeable.
- Adverse weather conditions and extremes in terrain may affect handling and/or performance of your vehicle. Refer to your chassis manual for related information.

FUEL AND PROPANE GAS

 **DANGER**

All pilot lights, appliances, and their ignitors (see operating instructions) shall be turned off before refueling of motor fuel tanks and/or propane containers. Failure to comply could result in death or serious injury.

 **WARNING**

Propane gas containers, gasoline, or other flammable liquids shall not be placed or stored onboard the vehicle because a fire or explosion may result. Propane gas containers are equipped with safety valves, which relieve excessive pressure by discharging gas to the atmosphere. Failure to comply could result in death or serious injury.

SECTION 2 – SAFETY AND PRECAUTIONS

TOUR

- All pilot lights must be extinguished and appliances turned off while refilling the fuel tank or LP gas tank.
- Never smoke while refilling vehicle fuel tank or LP gas tank.
- Never use an open flame to test for LP gas leaks. Replace all protective covers and caps on LP system after filling. Make sure valve is closed and the door is latched securely.
- Never connect natural gas to the LP gas system.
- When lighting range burners, **do not** turn burner controls to “On” and allow gas to escape before lighting match.
- Portable fuel-burning equipment, including wood and charcoal grills and stoves shall not be used inside the recreational vehicle. The use of this equipment inside the recreational vehicle may cause fires or asphyxiation.
- LP gas regulators must always be installed with the diaphragm vent facing downward. Regulators are equipped with a protective cover. Make sure that the regulator vent faces downward and that the cover is kept in place to minimize vent blockage, which could result in excessive gas pressure causing fire or explosion.
- The following warning label is located in the cooking area to remind you to provide an adequate supply of fresh air for combustion.



Unlike homes, the amount of oxygen supply is limited due to the size of the recreational vehicle, and proper ventilation when using the cooking appliance(s) avoids dangers of asphyxiation. It is especially important that cooking appliances not be used for comfort heating, as the danger of

asphyxiation is greater when the appliance is used for long periods of time. Failure to comply could result in death or serious injury.

LP GAS LEAKS

The following procedures are located in the vehicle near the range area. If you smell gas within the vehicle, quickly and carefully perform the procedures listed.

IF YOU SMELL PROPANE

- Extinguish any open flames, pilot lights, and all smoking materials.
- Do not touch electrical switches.
- Shut off the gas supply at the tank valve(s) or gas supply connection.
- Open doors and other ventilating openings.
- Leave the area until odor clears.
- Have the propane system checked and leakage source corrected before using again.

Failure to comply could result in death or serious injury.

PROPANE GAS LEAK DETECTOR

Your coach is equipped a propane gas leak detector, similar to the one shown below. The leak detector sounds an alarm if an unsafe amount of propane gas is present inside the coach.

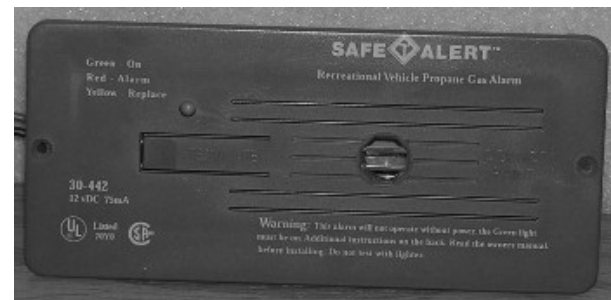

Propane Gas Leak Detector

Because propane gas is heavier than air, the leak detector is located on a cabinet face near the floor of the coach.

WARNING

EXPLOSION HAZARD: DO NOT use an open flame to test for gas leaks. When testing for gas line leaks with a soapy water solution, DO NOT use a detergent containing ammonia or chlorine. These substances may generate a chemical reaction causing corrosion to gas lines, resulting in dangerous leak conditions. Death or serious injury can result.

Power Connection

The propane gas leak detector is powered by the house batteries. If the house/coach battery switch is shut off or the battery cable is disconnected from the batteries, the alarm will not work. The propane gas leak detector fuse or circuit breaker is located in the 12-volt house electrical load center.

Because the propane gas leak detector is connected to the house battery, it is always drawing a small amount of current. Even though this current draw is slight, it could drain the house battery during storage periods when the house battery will not be charged regularly by the engine or shoreline.

Further Information

See the manufacturer's information in your InfoCase for further instructions on nuisance alarms and care and testing of the propane gas leak detector.

CARBON MONOXIDE WARNING

WARNING

Avoid inhaling exhaust gases, as they contain carbon monoxide, which is a colorless, odorless, and poisonous gas. Death or serious injury can result.

The best protection against carbon monoxide entry into the vehicle body is a properly maintained engine exhaust and ventilation system. It is recommended that the exhaust system and body be inspected by a qualified motor home service center:

- Each time the vehicle is serviced for an oil change.
- Whenever a change in the sound of the exhaust system is noticed.
- Whenever the exhaust system, underbody, or rear of the vehicle is damaged.

To allow proper operation of the vehicle's ventilation system, keep front ventilation inlet grill clear of snow, leaves, or other obstructions at all times. **DO NOT OCCUPY A PARKED VEHICLE WITH ENGINE RUNNING FOR AN EXTENDED PERIOD.**

Do not run engine in confined areas, such as a garage, except to move vehicle into or out of the area.

CARBON MONOXIDE ALARM

Your coach is equipped with a carbon monoxide (CO) alarm located on the ceiling in the bedroom area. The CO alarm is powered by a 9-volt battery and has a sensor that is designed to detect toxic carbon monoxide gas fumes resulting from incomplete combustion of fuel. It will detect CO gas from any combustion source such as the furnace, gas range/oven, water heater, refrigerator, chassis engine, and electric generator engine.



Carbon Monoxide Alarm

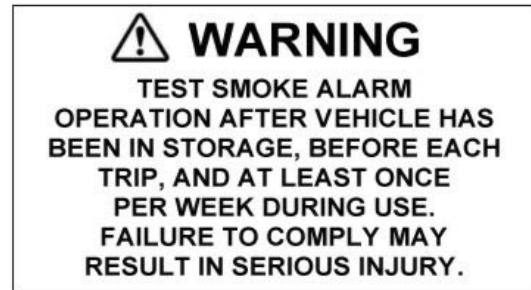
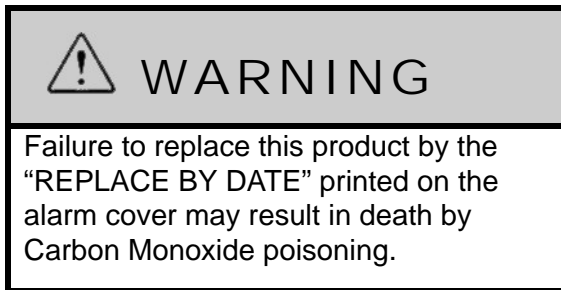

Replacement

When replacing this alarm, we recommend replacing only with the same model, or with one that is also listed for RV application. We recommend obtaining a replacement from your Winnebago Industries® dealer.

Further Information

Please read the information provided by the manufacturer, which is included in your InfoCase for further information.

Further Information

See the manufacturer's information in your InfoCase for further instructions.

Replacement

When replacing this alarm, we recommend replacing only with the same model, or with one that is also listed for RV application. We recommend obtaining a replacement from your Winnebago Industries® dealer.

SMOKE ALARM

Your motor home is equipped with a smoke alarm located on the ceiling in the lounge area. The smoke alarm is powered by a 9-volt battery and has a sensor that is designed to detect smoke.



Smoke Alarm

The following label is affixed to the smoke alarm.

FIRE EXTINGUISHER

A dry chemical fire extinguisher is located near the main entrance door.



Fire Extinguisher
(Typical installation - your coach may vary according to model and floorplan)

We recommend that you become thoroughly familiar with the operating instructions displayed on the side of the fire extinguisher and in the information supplied in your InfoCase.

We also recommend that you inspect the fire extinguisher for proper charge at least once a month in accordance with National Fire Protection Association (NFPA) recommendations as stated on the label.

If the charge is insufficient, the fire extinguisher must be replaced.

NOTICE

Do not test the fire extinguisher by discharging it. Partial discharge can cause leakage of pressure or contents, which would render the unit inoperative when needed. When using the fire extinguisher, aim the spray at the base of the fire.

Replacement

If for any reason you must replace the fire extinguisher, the replacement must be the same type and size as the one originally supplied in your coach. We recommend obtaining a replacement only from your Winnebago Industries® dealer or a reliable RV parts supplier.

ELECTRICAL

- Careless handling of electrical components can be fatal. Never touch or use electrical components or appliances while feet are bare, while hands are wet, or while standing in water or on wet ground.
- Improper grounding of the vehicle can cause personal injury. Do not plug the utility power cord into an outlet which is not grounded and do not adapt the plug to connect to a receptacle for which it is not designed.
- Do not attach an extension cord to the utility power cord.
- Do not use any electrical device that has had the ground pin removed.
- Avoid overloading electrical circuits. Replace fuses or circuit breakers with those of the same size and amperage rating only. Never use a higher rated fuse or breaker.
- Use caution when handling or working near electrical storage batteries. Always remove jewelry and wear protective clothing and eye covering. Avoid creating sparks.

LOADING

- Store or secure all loose items inside the motor home before traveling. Possible overlooked items such as canned goods or small appliances on the countertop, cooking pans on the range, or free-standing furniture items can become dangerous projectiles during a sudden stop.
- Be aware of GVWR, GAWR, and individual load limit on each tire or set of duals (See “Loading the Vehicle” in Section 12).
- Never load the motor home in excess of the gross vehicle weight rating of the gross axle weight rating for either axle.

MAINTENANCE

- Do not remove the radiator cap while engine and radiator are still hot. Always check coolant level visually at the see-through coolant reservoir.
- Never get beneath a vehicle that is held up by a jack only.
- Do not mix different construction types of tires on the vehicle, such as radial, bias, or belted tires, as vehicle handling may be affected. Replace tires with exact size, type, and load range.

EMERGENCY EXITS**Escape Window**

The bedroom escape window is secured by two red safety latches at the bottom of the window.

To open, lift both latches up and toward the center of the window, then push outward near the bottom of the window.



Escape Window - Lift latch handles upward to open

Using Slider Windows As Emergency Exits

Some coaches are required to have a slider window as an alternate exit. This window will be marked EXIT and have a red-handled latch.



Pull latch UP to slide window open

Most slider windows along the side of any motor home can also be used as alternate emergency exits, should the need arise.

To use a slider windows as an exit, first slide the window open, then either slide the screen open or push the screen material out, depending on window construction.

POWER SOFAS AND BEDS



WARNING

Keep people away from operating mechanism and pinch hazard areas during use. Failure to do so could cause injury.

SLIDEOUT ROOMS



WARNING

Your motor home may have more than one slideout room. Understand which switch operates which slideout room prior to operation. Make sure all slideout rooms are clear of people who could be harmed or obstacles that could cause damage prior to operating any slideout rooms. Failure to observe can result in death or serious injury.

Check inside and outside the vehicle to make sure that there are no people who could be harmed or obstacles that could cause damage due to room activation.



WARNING

Keep all persons clear of the slideout room and moving parts while extending or retracting. Do not occupy the slideout room while it is being extended or retracted. Failure to observe can result in death or serious injury.

FORMALDEHYDE INFORMATION

Some of the materials used in this recreational vehicle emit formaldehyde. Eye, nose, and throat irritation, headache, nausea, and a variety of asthma-like symptoms, including shortness of breath have been reported as a result of formaldehyde exposure. Reaction to formaldehyde exposure may vary among individuals. Elderly persons and young children, as well as anyone with a history of asthma, allergies, or lung problems may be at greater risk. Research is continuing on the possible long-term effects of exposure to formaldehyde. Inadequate ventilation may allow formaldehyde and other contaminants to accumulate in indoor air. Ventilation to dilute the indoor air may be obtained from a passive or mechanical ventilation system. Always be sure to thoroughly ventilate your recreational vehicle before and during each use. High indoor temperatures and humidity may raise formaldehyde levels. When a recreational vehicle is in areas subject to high temperatures, an air conditioning system can be used to control indoor temperature levels. If you have any questions regarding the health effects of formaldehyde, consult your doctor or local health department.

MOLD, MOISTURE, AND YOUR MOTOR HOME

What is Mold?

Molds are part of the natural environment. They are as old as the Earth itself and mold spores are almost everywhere at some level waiting to grow. Mold plays a part of nature by breaking down dead organic matter, such as fallen leaves and dead trees. Indoors however, mold growth should be avoided. Molds reproduce by means of tiny spores. Those spores are invisible to the naked eye and float throughout the outdoor and indoor air. Because of the nature of the use of a motor home, it is natural for a motor home to be introduced into an environment with mold spores.

Mold is a plant and requires its own special environment to grow. That environment includes organic materials, nutrients, moisture, and proper temperature.

How Can I Avoid Mold?

To reduce the ability for mold to grow, you must reduce what constitutes its growth environment. Mold can grow with the smallest of a nutrient base. Just small amounts of dirt or dust on the carpet can be enough to allow the mold process to begin. Keep the environment as clean as possible. Vacuum the carpet. Clean food spills thoroughly and quickly. Avoid grease buildup near the stove or sink. Clean the exhaust fan above the stove often.

Minimize moisture in your motor home and keep humidity low. Clean spills quickly. Do not allow condensation to build up. You can open windows and vents to minimize condensation. Use of the air conditioner can assist in removing moisture from the air. Avoid leaks, but if leaks do occur, make repairs promptly.

Avoid bringing mold into your motor home. Plants, cloths, books, and other household items may already have mold present. It is easy to transfer mold into your motor home environment.

Monitor your motor home. Periodically check those hidden areas in corners, closets, and cabinets to assure mold is not present.

What if I Find Mold?

If mold develops, clean the area with a concentrate of soap and bleach. Items that contain mold that cannot be cleaned should be removed from the vehicle.

Can Mold Harm Me?

The effects of mold and airborne mold spores may cause irritation to some people. Experts disagree on the level of exposure that may cause health concerns.

If Mold Is Present, What Will Winnebago Industries® Do?

If Winnebago Industries determines that mold is present in the Winnebago®/Itasca® motor home as a result of a manufacturing defect reported to Winnebago Industries within the limited warranty period, Winnebago will clean the affected area(s) and/or replace affected items as it deems necessary. This is the extent of coverage provided by Winnebago Industries. Winnebago Industries, however, will not assume responsibility for mold deemed to be a result of a motor home users lack of timely and appropriate action to mitigate circumstances should a problem occur.

If Winnebago Industries determines that mold is present due to conditions it determines is not a result of a manufacturing defect found within the warranty period, Winnebago Industries will not provide any financial assistance to the repair of the condition.

ROOF AND LADDERS

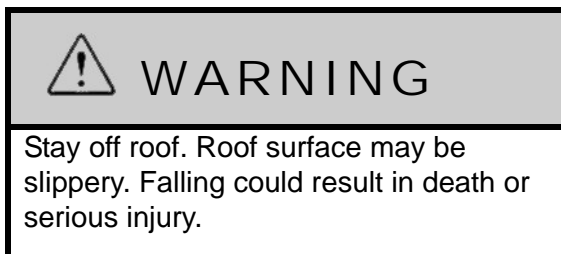

The ladder on your motor home is provided for limited access to the roof.

Walking or working on the roof should be left to qualified service personnel using proper safety equipment in a safe environment. You should only walk or work on the roof if you are qualified and have created a safe environment.

For your safety, it is not recommended that you store or carry items on the roof.

Before Using the Ladder

- **Inspect the ladder** to make sure it is not damaged. Never use a damaged ladder.

- **Keep the rungs of the ladder clean and dry** while in use. Never use the ladder when it is raining, snowing, or icy. The rungs can become slippery. Do not step onto the rungs if the rungs are wet, or if your shoes are wet or carry mud or debris that could result in a loss of footing.
- **Never ignore warning labels** or weight limits defined on your ladder. The following warning label is located on or near the ladder:

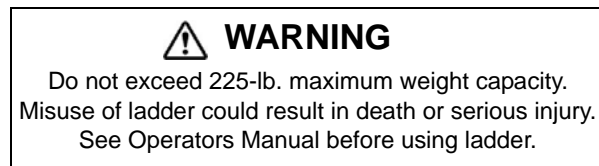

- **Maximum Capacity: 225 lbs.**
- **Do not overload.** Ladder is intended for one person.
- **Make sure you are physically capable** to safely use the ladder. Strength, flexibility, and stability are required.
- **Be aware that the vehicle may sway** as you climb the ladder. Do not use the ladder in high winds.
- **As you climb the ladder,** grasp the side rails firmly and always use both hands. Keep your body centered between the side rails. Do not over-reach.
- **Never allow children** on the ladder.
- **Do not transport items** anchored to the ladder. You could damage the ladder.

ROADSIDE EMERGENCY

Because of the size and weight of this vehicle and its tires, and the possible complications involved in tire changing, we strongly advise obtaining professional road service to change a flat tire whenever possible. However, if an emergency requires you to change the tire yourself, please exercise extreme caution and read all tire changing information in the chassis manual.

Never get beneath a vehicle that is held up by a jack only.

If You Get A Flat Tire

- DO NOT panic.
- Grip the steering wheel firmly and steer the vehicle as straight as possible. Avoid quick maneuvers. You may need to counter-steer to compensate for “pull” created by the failed tire.
- DO NOT stomp on the brake. This abruptly shifts the vehicle’s weight forward, making it nose-dive and pull toward the blown-out side.
- DO NOT jerk your foot off the accelerator. Just ease back on the accelerator slowly and gently to continue momentum. The deflated tire will slow the vehicle.
- If you must change lanes to get to a safe stopping place, use your signals to warn other motorists and change lanes smoothly and carefully after you are certain the lane is clear.
- Let the vehicle coast to a stop, gently steering to a safe stopping place off the traffic lanes of the road. Do not worry about damaging the tire or wheel rim by driving on it. A tire or wheel replacement is cheaper than damaging the vehicle or injuring yourself.
- When you have come to a stop, activate your hazard flashers to warn other motorists, then exit the vehicle carefully.
- Set out flares or other warning devices.

Check your tires for proper inflation before each trip and at least once a month with an accurate tire gauge.

Recovery Towing

When calling a professional towing service, we recommend that you advise them of your coach length and approximate front axle weight listed on your Vehicle Certification Label. This will allow the towing operator to determine the proper towing equipment to use.

We recommend that you ask for an underlift (wheel lift or frame lift) type towing assembly for safe towing.

Winnebago Industries® does not assume responsibility for damage incurred while towing this vehicle.

NOTE: Consult the chassis manual for any additional towing instructions or precautions provided by the chassis manufacturer.

NOTICE

Do not lift on bumper. Damage will result to front end body parts.



WARNING

Stay out from beneath the motor home while it is suspended by the towing assembly. Do not allow passengers to occupy a towed vehicle. Death or serious injury can result.

JUMP STARTING

If your coach will not start from the chassis battery, try using the battery boost switch to divert power from the house batteries to the starter. (See either “Battery Boost Switch” or “Aux Start Switch”).

If you wish to try jump starting the engine using another vehicle or booster system, see your chassis manual for connecting jumper cables to the automotive electrical system.

NOTICE

Do not attempt to push start this vehicle. Damage to the transmission or other parts of the vehicle will occur.

ENGINE OVERHEAT

If you see or hear steam escaping from the engine compartment or have any other reason to suspect an extreme engine overheating condition, pull the vehicle over to the roadside as soon as it is safe to do so, stop the engine, and get all passengers out of the vehicle.

<h3>NOTICE</h3>
Operating a vehicle under a severe overheating condition can result in damage to the vehicle.

For information on what to do in case of overheating, consult your chassis manual.

TOUR

SECTION 3 – DRIVING YOUR MOTOR HOME

The information in this section refers only to features installed or adapted to the dash and driver compartment area by Winnebago Industries®. It also includes passenger seating in the living area of the coach.

Further Information

See the chassis manual in your InfoCase for all original chassis related controls, instrumentation, switches, and other features. This includes items such as transmission, parking brakes, cruise control, gauges, wipers, lights, etc.

SEATS – DRIVER/CO-PILOT

Multi-Adjustable Power Seats

The driver and co-pilot seats may be independently adjusted to suit individual preference.

The seats may be swiveled to provide easy entrance and exit. The swivel feature also allows the seats on most models to be turned toward the living area for additional seating while the unit is parked.

 WARNING
Assure seat is in its forward and locked position for travel. Do not adjust seat while vehicle is in motion. Failure to comply may result in injuries.

The power seat controls are located on the lower aisle side of the seat base.

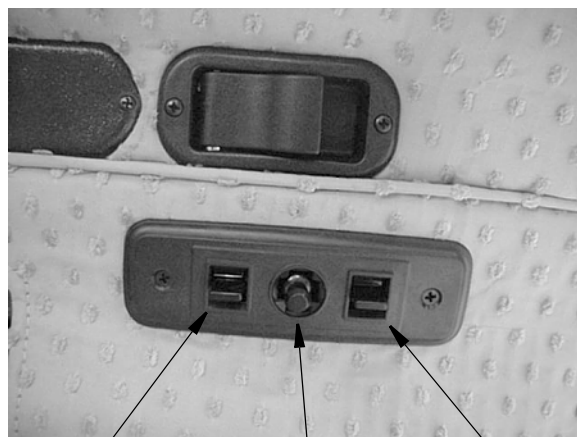

Hip Area
-Up/Down

Main Seat
Position
-Up/Down
-Fore/Aft

Knee Area
-Up/Down

To Face Driver's Seat Rearward

- Tilt the steering wheel all the way up and put the left armrest down.
- Move the seat rearward fully and then ahead a few inches.
- Swivel the seat to the right until it just contacts the steering wheel, then move the seat ahead all the way to clear the steering wheel.
- Swivel the seat the rest of the way to face the living area.
- Position the tilt wheel down and to provide maximum clearance to recline the seat.
- Reverse the procedure to face the seat forward.

Armrest Adjustment

The armrests may be swung upward out of the way for easy exit or access to the front seats. A roller on the underside of the front of the armrest also lets you adjust the resting angle for personal comfort, whether the seat is upright or reclined.



HEATED SEATS

(Driver and Passenger Seats)

- If Equipped

Your coach may be equipped with heated driver and passenger seats.

When the heated seat switch is in the middle position, the heater is OFF.

- High Heat Setting - For maximum heat output, press the heated seat switch UP.
- Low Heat Setting - For lower heat output, press the heated seat switch DOWN.

The heated seat control module is programmed to automatically shut off after one hour of operation.

NOTE: The heated seats are only operable when the ignition key is turned ON.

Seat Heater Control Switch
(Located on the side of the driver
and passenger seats)
-Typical View

PASSENGER FOOTREST

-If Equipped

The co-pilot seat is equipped with a manual footrest that provides greater utility to be used as a lounge chair when rotated for television viewing or as part of a lounge conversational area.

- To extend footrest, lift black footrest lever (located on right-hand side of seat).
- To retract footrest, push downward with your legs and the footrest will close.

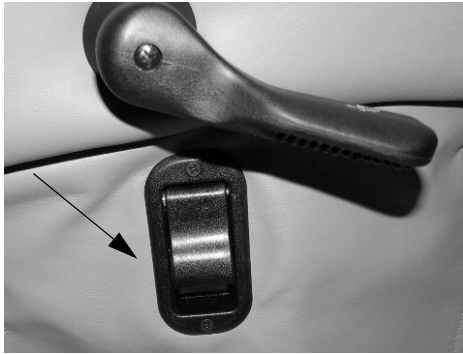

Passenger Footrest Lever
(Located on right-hand
side of passenger seat)
-Typical View

SEAT BELTS

Seats intended for occupancy while the vehicle is in motion are equipped with seat belts for the protection of the driver and passengers.

Lap Belts

The lap belts must be worn as low as possible and fit snugly across the hip area. Always sit erect and well back into the seat. To gain full protection of the safety belt, never let more than one person use the same safety belt at any one time, and do not let the safety belts become damaged by pinching them in the doors or in the seat mechanism. After any serious accident, any seat belts which were in use at the time must be inspected and replaced if necessary.

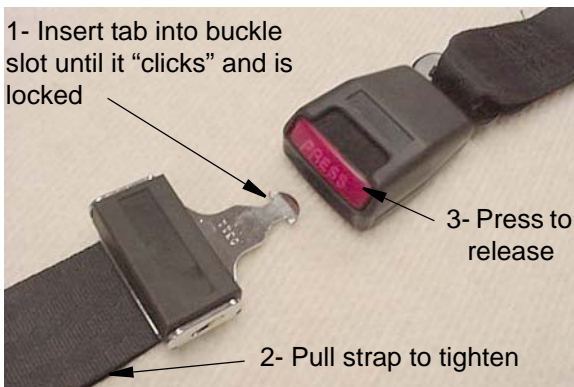

Adjustment

To lengthen belt, swivel the tab end at a right angle to belt and pull strap to desired length. To shorten, pull loose end of belt.

To Fasten

Be sure belt is not twisted. Grasp each part of the belt assembly and push tongue into buckle. Adjust to a snug fit by pulling the loose end away from the tongue.

To Release

Press button in center of buckle and slide tongue out of buckle.



WARNING

Snug and low belt positions are essential. This will ensure that the force exerted by the lap belt in a collision is spread over the strong hip area and not across the abdomen, which could result in serious injury. Only seats equipped with seat belts are to be occupied while vehicle is in motion.

Lap/Shoulder Belts

Fastening

Hold the belt just behind the tongue using the hand nearest to the door. Next, bring the belt across the body and insert the tongue into the buckle until the latch engages.

Unfastening

Press the release button in the buckle. Hold onto the tongue when you release it from the buckle to keep it from retracting too rapidly.

When the lap-shoulder belt is in use, the lap belt must ride low across the hip area and the shoulder belt must ride diagonally over the shoulder toward the buckle.

The shoulder belt is designed to lock only during a sudden stop, sudden body movement or a collision. At all other times it will move freely with the occupant.



WARNING

Never wear the shoulder belt in any position other than as stated above. Failure to do so could increase the chance or extent of injury in a collision.

Seat Belt Care and Cleaning

- Be careful not to damage the belt webbing and hardware. Take care not to pinch them in the seat or doors.
- Inspect the belts and hardware periodically. Check for cuts, frays, and loose parts. Damaged parts should be replaced. Do not remove or modify the belt system.
- Keep belts clean and dry. If the belts need cleaning, use only a mild soap and water solution. Do not use hot water. Do not use abrasive cleaners, bleach, or dyes. These products may weaken the belts.
- Replace any belt assembly that was used during a severe impact. Replace the complete assembly even if damage is not apparent.

CHILD RESTRAINTS

-If Equipped

A properly installed and secured child restraint system can help reduce the chance or severity of personal injury to a child in an accident or during a sudden maneuver. Children may have a greater chance of being injured in an accident if they are seated in a child restraint system which is not properly secured.

A child restraint system is designed to be secured in a vehicle seat by a lap belt or the lap belt portion of a lap-shoulder belt.

When purchasing a child restraint system, follow these guidelines:

1. Look for the label certifying that it meets all applicable safety standards.

2. Make sure that it will attach to your vehicle and restrain your child securely and conveniently so that you are able to install it correctly each time it is used.
3. Be certain that it is appropriate for the child's height, weight, and development. The instructions and/or the regulation label attached to the restraint typically provides this information.
4. Review the instructions for installation and use of the restraint. Be sure that you understand them fully and can install the restraint properly and safely in your vehicle.

Tether Anchor Loop

-If Equipped

If your coach has a dinette, it may be equipped with a child seat tether anchor loop located on the floor directly behind the forward facing dinette seat.



The dinette table must be in the lowered position when a child seat is in use.



1. Lower the dinette table.
2. Route the tether over the top of the dinette seat back and hook it to the anchor loop on the floor.
3. Fasten the lap belt.

See the child seat manufacturer's specific instructions for proper attachment and adjustment of the tether and seat belts.

KEYONE™ LOCK SYSTEM

-If Equipped

Your coach is equipped with the KeyOne lock system. A single key will open every door lock in the entire motor home (except the security deadbolt lock on the entrance door).

The key number for your coach is registered in our factory database, so if you ever lose your keys, any Winnebago Industries® dealership can order a new key for you.

POWER DOOR LOCKS

The power door locks control the main side entrance door and storage compartment locks. The switches are located on the entry switch panel and the dash.



Power Door Locks
(Located on entry switch panel)
-Typical View



Power Door Locks
(Located on dash)
-Typical View

Keyless Remote Entry System with Cargo Lock Feature

Your motor home is equipped with a Keyless Entry System that will permit keyless locking and unlocking of your coach and cargo doors by simply pressing the key ring remote.



Keyless Remote Unit
-Typical View

Reprogramming Remote

When replacing batteries, the remote unit may need to be reprogrammed with a switch on the keyless entry system control box.

The entry system control box is located behind the circuit breaker mounting panel in the 12-volt electrical compartment at the front left side of the coach.

To access the keyless entry control box, remove 4 screws and open the panel carefully to avoid damage or disconnection of wiring looms.



Keyless Entry Control Box
(Located in 12-volt electrical compartment)
-Typical View

The programming switch is protected by a sealing label as indicated on the box.

See the Keyless Entry System operating guide in your InfoCase for programming sequence.

Further Information

Please read the Keyless Entry System information in your InfoCase for a full description of all system features.

MIRRORS – POWER ELECTRIC

Always adjust mirrors for maximum rear visibility before driving. Make sure the seat is adjusted for proper vehicle control and that you are sitting back squarely into the seat.



Mirror Adjustment Control

The mirror control is located on the driver side armrest panel or the dash. The ignition key must be on to adjust the mirrors.

Move Selector Switch L or R to select mirror.
Center “neutral” position disables arrows to avoid unintentionally moving a mirror

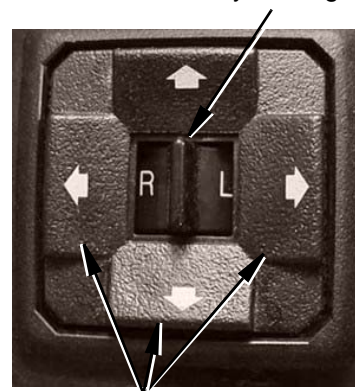

Press Arrow Buttons to move mirror surface in direction indicated

Mirror Heaters

The mirrors may also contain heating elements to defog or de-ice the mirror glass during cold weather operation. An ON-OFF switch for the mirror heaters is located near the remote mirror controls.

Mirror Arm/Head Adjustment

If you cannot adjust a mirror properly using the control switch, the mirror may need a coarse adjustment by repositioning the mirror arm and/or rotating the mirror head.

Mirror Head Pivot Lock



Unscrew protective cap and loosen Allen head set screw to pivot mirror head



Allen Head Set Screw*
(Torque screw to 75-100 in./lbs.)

**Set screws may be located on the opposite side of the mirror arm. Passenger and Driver side mirrors are similar.*

Mirror Arm Mounting Base



Unscrew protective caps and loosen Allen head set screws to pivot mirror arm.
(Torque screws to 75-100 in./lbs.)

If mirror arm will not pivot with set screws loosened, you may also need to loosen the mirror arm pivot bolt on the underside of the mounting base shown. Be sure to tighten this bolt when adjustment is done.

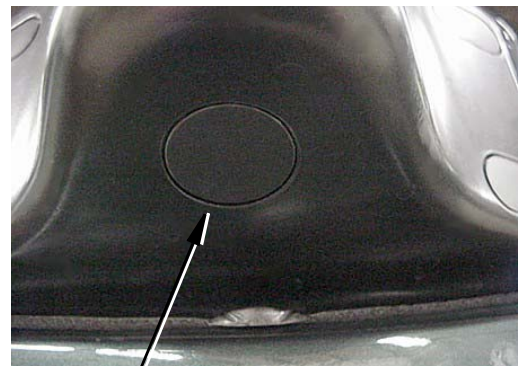

Carefully pry out plug on underside of mirror base to access pivot bolt



Mirror Arm Pivot Bolt
on underside of mounting base
- Shown with access plug removed
(Torque nut to 75-100 in./lbs.)

REARVIEW MONITOR SYSTEM

-If Equipped



The rearview camera monitor system lets you see what is directly behind your coach for maneuvering assistance and safety.

A microphone built into the rear camera lets you hear warning sounds or verbal directions from an assistant.

Basic Operating Instructions



Power

- Turn ON to activate monitor for rear viewing while driving or parked. Key must be on.
- In OFF (Standby) position the monitor is “asleep” and will “wake up” when the transmission is shifted into reverse.

Menu

- Each one press less than 1 second enters brightness, contrast, color, or tint adjust mode. (Time out of menu is approximately 5 seconds from last key pressed.)
- Press menu button over 2 seconds to enter setup menu. (Press again before time out exits menu mode.)

Select

- Pressing the “Select” button sequences source input modes from Ch1, to Ch2, to Ch3.

Up/Down

- Pressing UP increases brightness, contrast, color, or tint level.
- Pressing DN decreases brightness, contrast, color, or tint level.

Day/Night

- Pressing DAY/NIGHT button sequences day/night backlight compensation through DAY, NIGHT, and AUTO modes.

Volume +/-

- Pressing “+” button increases speaker volume.
- Pressing “-” decreases speaker volume.

Sideview Cameras

-If Equipped

The optional sideview cameras allow you to see what is beside you before turning or changing lanes.

The sideview cameras activate with the corresponding turn signals and replace the rear camera view on the monitor until the turn is completed or the signal lever is canceled manually.

Further Information

See the rearview monitor manufacturer’s complete operating information in your InfoCase.

REARVIEW MONITOR SYSTEM –If Equipped



The rearview camera monitor system lets you see what is directly behind your coach for maneuvering assistance and safety. Optional sideview cameras* also allow you to see what is beside you before turning or changing lanes.

The monitor screen “wakes up” automatically when transmission is shifted into reverse. A microphone built into the rear camera lets you hear warning sounds or verbal directions from an assistant.

The monitor screen also doubles as a secondary display panel for the optional GPS system, if desired.

Basic Operating Instructions



Power - In STANDBY position, the monitor is “asleep” and will “wake up” when the transmission is shifted into Reverse.

The ON position activates the monitor for rear viewing while driving or parked. Key must be on.

Input Camera/Aux - Press to switch between viewing Camera(s) or Aux GPS display (optional) on monitor.

Night/Day - Press to adjust contrast and brightness for nighttime and daytime lighting conditions. After making adjustments, button is used to switch between settings.

Sideview Cameras* (if equipped)

The optional sideview cameras activate with the corresponding turn signals and replace the rear camera view on the monitor until the turn is completed or the signal lever is canceled manually.

Further Information

See the rearview monitor manufacturer’s complete operating information in your InfoCase.

12-VOLT FRONT DROP-DOWN SOLAR/NIGHT SHADE

–If Equipped

Your coach is equipped with a 12V Front Drop-Down Solar/Night Shade that provides privacy and solar heat protection as well as a sunvisor feature.

The power switches for the 12V Front Drop-Down Solar/Night Shade are located on the driver side trim panel.



Press the Solar Shade (black) or the Night Shade (white) switch up or down to adjust the shade to the setting that best suits your needs.

Dual range motors provide lowering of either two shades to visor height restriction when the ignition is ON and lowers completely to cover the entire windshield when the ignition is OFF.

The Chassis Battery Disconnect switch must be ON to supply power to the solar/night shade.

SECTION 3 – DRIVING YOUR MOTOR HOME

TOUR

NOTE: If power is gradually drained and falls below the lower limit of 11-volts, the motors could lose their electronic Set Limits and will require reprogramming once normal power has been restored. Refer to the Solar/Night Shade manufacturer's information provided in your InfoCase.

ELECTRONIC COMPASS AND OUTSIDE THERMOMETER



- **F/C Button** - Press to switch between Fahrenheit and Celsius temperature degree scales. When display is off, press and hold to check temperature.
- **Mode Button** - Press to "page through" functions: Compass > Thermometer > Calibration.

Further Information

See the compass manufacturer's guide in your InfoCase for detailed operating instructions, calibration, specifications, and other information.

GPS NAVIGATION SYSTEM

-If Equipped

The GPS navigation system can help you confidently chart your course through the most dense concrete jungle or remote country backroad using global satellite positioning technology.

Navigational information is displayed on either the GPS display panel or the rearview monitor screen using the GPS remote control.



GPS Display Panel
(Mounted on top of the dash area)

NOTE: Be sure the Input Button on the GPS Display Panel is set to VIDEO 1.

To operate GPS from the rearview monitor, press the Input Camera/Aux Switch on the rearview monitor.



Rearview Monitor
(Located within the dash area)



GPS Control Module
(Located inside driver side
overhead compartment)

GPS Remote
Control

Further Information

See the GPS system manufacturer’s information in your InfoCase for complete setup and operating instructions.

PARKING BRAKE

Freightliner® Chassis



Parking Brake Knob
-Typical View

- Pull to apply
- Push in to release

Use the parking brake knob to apply the park brake whenever the vehicle is parked.

Never try to drive the vehicle with the parking brake applied. This can cause excessive wear on the brakes and may damage the transmission.

NOTE: It is normal to hear an occasional burst of air pressure from the rear of the vehicle. This is an automatic moisture purging feature of the air brake system. See the Brakes section of your chassis manual for instructions on periodic draining of brake air tank.

ENGINE BRAKE SYSTEM

Freightliner® Chassis

Many large diesel trucks are equipped with a compression release engine brake system, commonly referred to as a “jake brake”– so named for Jacobs Vehicle Systems™, the originator of this type of braking system.

The engine brake is a device mounted on top of the diesel engine that temporarily changes the timing of the exhaust valves, momentarily

shutting down either three cylinders or all six cylinders, depending on Low or High setting. This turns the power-producing diesel engine into a power-absorbing compressor, which provides effective deceleration of the vehicle. Combined with use of the chassis air brakes, the engine brake delivers a substantial degree of braking power.

The engine brake activation switch is located on the lower left side of the dash. Press and release the ON side of the switch to activate the engine brake system. The engine brake will operate whenever you let up on the throttle pedal while the switch is ON.

Engine Brake Operation

- **Low – Press for normal braking** on level or shallow grades and in-town and city driving. This shuts down three of the six cylinders when engaged and provides about 130-hp of braking power. The switch indicator light will be on.



- **High – Press for additional braking on steep grades** and mountain driving. This shuts down all six cylinders when engaged and provides about 300-hp of braking power. The switch indicator light will be on.
- **The middle position is Off.** The engine brake is deactivated. Only the chassis air brakes are active at this setting. The switch indicator light will be off.

-Typical View

 **WARNING**

Do not use the exhaust brake if road surfaces are slippery. Using the exhaust brake on wet, icy, or snow-covered roads could result in loss of vehicle control, possibly causing personal injury or death, or property damage.

Further Information

See your chassis manual in your InfoCase for more instructions, information, and precautions on using this feature.

TAG AXLE SUSPENSION SYSTEM

Freightliner® Chassis -If Equipped

Your coach may be equipped with a Tag Axle Suspension System, which is designed to increase the Gross Vehicle Weight Rating (GVWR). This system is to be used when the rear suspension/axle will be loaded to a weight greater than 20,000 lbs. When certain conditions arise, air can be exhausted from the air springs to improve maneuverability or traction on the rear axle by operating the Tag Axle switch (located on the driver side trim panel).



Tag Axle Switch
(Located on the driver side trim panel)
-Typical View

Tag Axle Switch Operation

Tag Dump Position

- Press and Hold switch in the TAG DUMP position for the Tag Axle air pressure to remain reduced and maintain the maneuverability or traction benefit desired.

Auto Dump Position

- This mode is activated automatically when in reverse gear, when the Tag Axle switch is in the MIDDLE position. The Auto Dump feature gives you better maneuverability while driving in reverse.

Off Position

- The Tag Dump mode is inactive when the Tag Axle switch is in the OFF position.

NOTE: If an override event occurs while the switch is held in the Tag Dump position, the switch must be cycled on and off to clear the override command.

Further Information

See the chassis manual provided in your InfoCase for more information and precautions on using this feature.

HAZARD WARNING FLASHERS

The hazard warning flashers provide additional safety when the vehicle must be stopped on the side of the roadway and presents a possible hazard to other motorists. When the flashers are on, it serves as a warning to other drivers.



NOTE: Move multi-function lever up or down to cancel.

Further Information

See the chassis manual in your InfoCase for instructions on activating, operating, and canceling hazard warning flashers.

SIGNAL LEVER/HEADLIGHT HI/LO BEAM

The signal lever controls the turn signals and high/low beam changing.



Turn Signals/Hi-Lo Beams
(Typical View - your coach may differ depending on model)

Move multi-function lever upward for right turn signal and downward for left turn signal. An audible chime will alert you when the signals are flashing.

Pull end of handle toward you to switch headlight high/low beams.

Further Information

See your chassis manual for further operating instructions and features.

MAP LIGHT SWITCH

Turn the map light on using the Panel Light brightness thumbwheel control. Roll it upward until you feel it click into the map light “On” position.

The “Cargo” Switch and the “Push” Switch (for fog lights) are non-functional.



Further Information

See your chassis manual in your InfoCase for further information on this switch.

STEERING COLUMN ADJUSTMENT

The tilt/telescope adjustment pedal is located on the floor to the left of the steering column as shown.



- Press pedal to adjust steering wheel tilt or telescope

Adjust Steering Wheel or Column

Press the pedal down to adjust either the tilt or telescope. Release the pedal when you have adjusted the tilt angle or steering wheel distance to your preferred position.



WARNING

Do not adjust the steering column or tilt wheel while the vehicle is in motion. Doing so may cause loss of vehicle control resulting in death or personal injury.

SMARTWHEEL™ STEERING WHEEL CONTROL SYSTEM

–If Equipped

The steering wheel control system offers convenient and safe control of the horn, headlight, marker light flash, cruise control, and wiper functions all from switch panels mounted at your fingertips on the steering wheel.

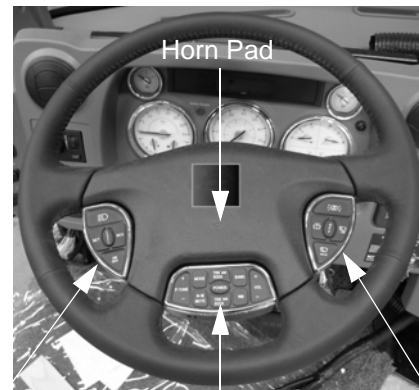

Cruise
Control
Pad

Radio Remote

Wiper
Control
Pad

Horn Pad

- Normally sounds the chassis horn.
- Also sounds air horns if Air Horn switch on dash is activated.

Headlight Courtesy Flash



- Press and release to blink or flash the headlights.
- Night: If the headlights are already turned on, pressing the switch will blink them off briefly.
- Day: If the headlights are off, pressing the switch will flash them on briefly.

NOTE: Truckers often use this signal to indicate to a passing rig when it is clear to pull back into the lane ahead of them.

Marker Light Courtesy Flash



- Press and release to blink or flash the marker (clearance) lights.
- Night: If the marker lights are already turned on, pressing the switch will blink them off briefly.
- Day: If the marker lights are off, pressing the switch will flash them on briefly.

NOTE: Truckers often use this signal as a greeting or an expression of thanks for assistance in passing, etc.

Cruise Control Functions



On/Off (Cruise System On/Off)

- Press to turn cruise control system on or off.
- This will also erase previously set speed.

Set (Set Speed/Coast)

- Press to maintain current desired driving speed. Will not work below 40 mph.
- This button will also perform “Coast” feature. Press and hold until vehicle slows to desired speed and release to establish new “set” speed.

Res (Resume/Accel)

- Press to return to previous “set” speed after braking or reducing speed.

Cancel

- Press to switch cruise function off without losing current “set” speed.

! WARNING

Do not operate the cruise control on icy or extremely wet roads, winding roads, in heavy traffic, or in any other traffic situation where a constant speed cannot be maintained.

Wiper Functions



There are four wiper control buttons:

- Wiper On - HI/LO
- Wiper Off
- Wiper Delay
- Wash/Wipe

NOTE: Many states now have laws that require headlights to be on during precipitation conditions. To assure compliance with this law, the headlights will come on whenever you press any of the wiper function buttons - Hi/Lo, Wash, or Delay. Headlights will turn off when the ignition switch is turned off.

Wiper On - Hi/Lo

- Press to turn wipers on at Lo speed;
- then press again to switch wiper speed back and forth from Lo to Hi speed.
- Press Off button to switch wipers off.

Wiper Off

- Press to shut wipers off.
- Wipers will also switch off when the ignition is turned off.

Wiper Delay

This switch will set a Lo speed wiper delay time based on the duration between any two presses of the button.

How it works:

- During a light rain or mist, when your windshield needs a clearing wipe, press the button once and the wiper will swipe back and forth once at Lo speed. Let's say 7 seconds later, the windshield needs another wipe - press the button again and the delay time will be set to 7 seconds.
- If the mist gets heavier and you press the button again 3 seconds after the last wipe, the delay time will be reset to 3 seconds.
- The delay time can be set from approximately 1 to 30 seconds.

Wash/Wipe

- Press switch to activate Lo wipers and spray washer fluid onto the windshield for as long as you hold the button.
- After you release the button, the wipers will continue for three wipe cycles, then turn off.

- If wipers are already active, pressing the switch will simply spray fluid onto the windshield without affecting wiper setting.

Idle Speed Control

The cruise control system can also be used to control diesel engine idle speed (rpm) while parked.

High Idle

- Shift the transmission into Neutral (N).
- On the turn signal lever, move the slide switch to the ON position or press the ON button on the steering wheel. Accelerate to the desired rpm. Press and release the SET/COAST or SET/COAST button on the steering wheel.
- Disengage by stepping on the brake pedal, by moving the ON/OFF switch to the OFF position, or by pressing the OFF button on the steering wheel.

 CAUTION
Do not operate engine at low idle for long periods with engine coolant temperature below the minimum specification in your diesel engine manual. This can result in the following: <ul style="list-style-type: none">• Fuel dilution of the lubricating oil• Carbon build up in the cylinder• Cylinder head valve sticking• Reduced performance

Further Information

See the chassis manual in your InfoCase for complete operating instructions and other information on all of the features of your SmartWheel.

BATTERY BOOST SWITCH

This switch can be used to draw emergency starting power from the house batteries to start the engine if the chassis battery is discharged.

Press and hold in the ON position while turning ignition key for emergency starting power.

NOTE: The House/Coach Battery Disconnect switch near the entrance door must be ON and house batteries must be sufficiently charged for this feature to work.



Battery Boost Switch
(If chassis battery is discharged, press and hold while turning ignition key for emergency starting power)
-Typical View

AIR CONDITIONER/HEATER – AUTOMOTIVE (DASH)

Controls for the air conditioner, heater, defroster, and vent are all combined into one control panel.

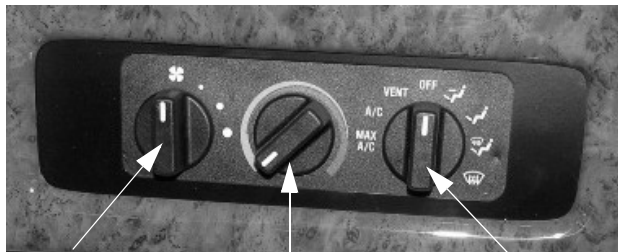

Fan
Switch

Temp
Control

Mode
Selector

NOTE: The dash air conditioner/heater is not designed to heat and cool the entire interior of the coach, but is intended only to provide heating and cooling for the cab area.

Further Information

See the manufacturer's user guide provided in your InfoCase for complete operating instructions.

DEFROST FANS

– If Equipped

The two-speed auxiliary fans are intended to assist the automotive windshield defroster system in clearing fog and frost in cold weather or humid conditions.

The middle position on the switch is OFF.

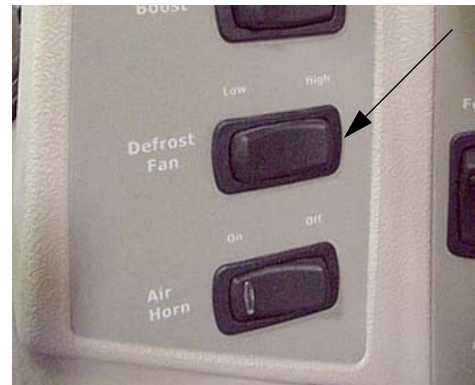

Defrost Fan Switch
(Located in dash area)
-Typical View

RADIO – IN-DASH

-If Equipped

The radio in your coach can receive AM/FM stereo and weather band stations. It also has a compact disc (CD) player for your listening enjoyment through quality high-output speakers located in several areas of the coach.



Please refer to the manufacturer’s operating guide in your InfoCase for detailed instructions on programming preset station buttons and using this full-featured radio/audio system.

Satellite Radio

-If Equipped

Your coach may be equipped with a Sirius® satellite radio receiver that plays through your radio.

See the receiver manufacturer’s information in your InfoCase for programming and operating instructions.

NOTE: If your Sirius tuner is not activated, follow the instructions in the radio owners manual in your InfoCase for the phone number to call and procedure to access the Sirius Tuner ID Number (ESN).

iPod Cable

-If Equipped

Your coach may be equipped with a cable to connect your iPod to play through your dash radio. This cable is in the overhead compartment above the driver’s seat. The cable is shown in the following photo.



-Typical View

See the manufacturer’s information in your InfoCase for operating instructions.

Radio Remote Controls

A steering wheel mounted remote control for the radio lets you change radio stations or CD selections without taking your eyes off the road or hands off the wheel.



Radio Remote Control
(Freightliner® and Workhorse™ Chassis)
-Typical View



Radio Remote Control
(Ford® Chassis)
-Typical View

An additional hand-held remote allows these same conveniences for the passenger. The hand-held radio remote is in your InfoCase.

Radio Power Switch

The radio power switch lets you connect the dash radio to the coach batteries with the ignition switch turned off for listening while parked. This prevents accidental draining of the chassis battery with prolonged use of the radio.

NOTE: The Coach/House Battery Disconnect Switch must be on while listening to the dash radio because the audio relay is powered by house batteries. If the Coach/House Battery Disconnect Switch is off, the speakers will not emit sound.



Radio Power Switch
(Located in dash area)

-Typical View

- Press HOUSE to listen to the radio while parked without the ignition key on.
- Press ENGINE to listen while driving.

SIRIUS® PLUG AND PLAY SATELLITE RADIO

-If Equipped

(Located inside the driver or passenger side overhead compartment)

Take Sirius Plug and Play on the go - in your RV, at home, the office, other vehicles, or anywhere else! It is featured with universal docking capability so you can easily move Sirius to different locations and enjoy your favorite programming (separate docking station included).



To install the satellite unit, place your Sirius radio into the docking station, aligning the tabs at the edges of the the radio adapter with the grooves in your radio. Gently push the radio down until it is fully seated in the docking station.



For complete operating instructions, see the dash radio and satellite radio receiver user guide provided in your InfoCase.

When your Sirius radio is connected via the SiriusConnect Docking Kit to the dash radio, the buttons and controls of the Sirius radio will be disabled, and a SiriusConnect message or logo will be displayed.

To remove the satellite unit from the docking station, press the release button while pulling the radio out of the docking station. You can now take your Sirius Plug and Play and install it in your car with the supplied car kit.



Further Information

See the dash radio/satellite radio receiver user guide provided in your InfoCase for complete operating and installation instructions.

CB RADIO POWER WIRING

Your coach is pre-wired for CB radio power connection. The wires are located beneath the dash to the left of the steering wheel.

Look for a pair of wires - yellow (+) and white (-) with connectors and flag labels suspended from the wiring harness.



CB Power Wires
(in plastic sheath)
Typical view - your coach
may differ slightly

AIR HORNS

-If Equipped

Press the Air Horn switch on the dash or driver's side trim panel to the ON position, then use the horn button on the steering wheel to sound the air horns. The switch enables the air horn system to work with the standard chassis horn.

Press the Air Horn switch OFF to disable the air horns.

The air horn sound units are located behind the front grille assembly.

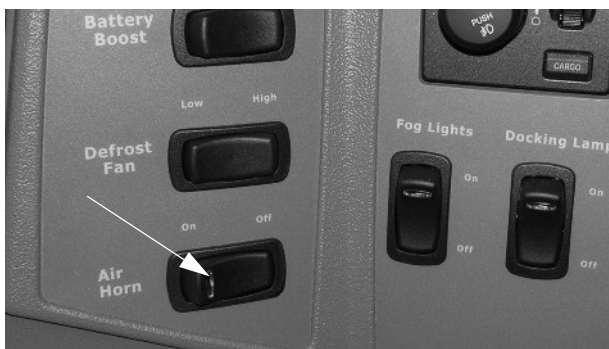

Air Horn Switch
(Located on dash or driver side trim panel)
-Typical View

FUEL SELECTION – DIESEL ENGINE

-If Equipped

Refer to your chassis manual for the manufacturer's recommendations on proper fuel selection (ULSD fuel only).

Winter Fuel Waxing and Anti-Gel Additives

In sub-freezing temperatures, #2 diesel fuel can form small wax crystals that become trapped in the fuel filter and block the fuel flow to the engine, causing it to stall out. At sub-zero temperatures, the fuel can congeal and turn “slushy.” If this happens, the only remedy is to have the vehicle towed into a heated facility to allow the fuel to warm up and become fully liquid again.

During winter time, most truck stops and reputable filling stations have winter blend diesel fuels available that are less susceptible to waxing.

There are also commercially available products (typically called anti-gel additives) to add to diesel fuel while filling the tank to inhibit wax formation in freezing temperatures.

Further Information

Consult your chassis manual or diesel engine guide in your InfoCase for more information on fuel requirements and additives.

FILLING THE FUEL TANK – DIESEL ENGINE

-If Equipped

Diesel fuel, especially #2 grade, can foam up while being pumped into the tank. Sometimes this foam can cause the pump nozzle to shut off before the tank is actually full. Allow the foam to settle then resume filling at a slower flow rate until the tank is full.

STARTING AND STOPPING DIESEL ENGINE

–If Equipped

Refer to the chassis manual in your InfoCase for the manufacturer's recommendations on starting and stopping the engine.

See also “Engine Block Heater” in this section.

Do not attempt to start the vehicle by hot-wiring.

Idling Diesel Engine

NOTICE

Do not operate engine at low idle for long periods with engine coolant temperature below the minimum specification in your diesel engine manual. This can result in the following:

- Fuel dilution of the lubricating oil
- Carbon build up in the cylinder
- Cylinder head valve sticking

Reduced performance

See also “Idle Speed Control” elsewhere in this section.

WARNING

DO NOT USE ETHER
OR STARTING FLUID

INTAKE MANIFOLD HEATER
MAY CAUSE EXPLOSION
AND SEVERE INJURY.

ENGINE BLOCK HEATER – DIESEL ENGINE

–If Equipped

Your diesel engine is equipped with an engine coolant heater to assist starting in freezing temperatures. The power cord is located in the rear cargo compartment on the driver side of the

coach. When plugged into the receptacle, the heater is connected to both the shoreline and the auxiliary generator, so a separate extension cord is not needed. The power switch is a standard household light switch located near the OnePlace® Systems Monitor Panel.



Diesel Engine Heater Switch
-Typical View

REMEMBER! Turn the engine heater switch off after starting the engine. The heater will keep operating for as long as it is supplied with electricity. If the switch is left on, the engine heater will come on each time you hook up the shoreline cord or start the generator.

ENGINE SERVICE ACCESS GRILLE – REAR

The diesel engine is located behind the grille panel at the rear of the vehicle.

Release the latches near the ends of the grille panel and swing it upward.

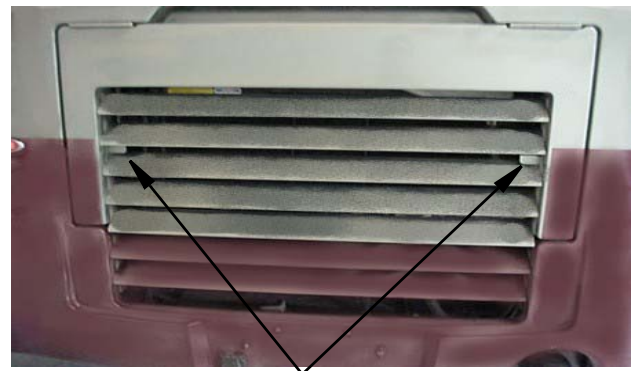

Lift latches and swing grille upward

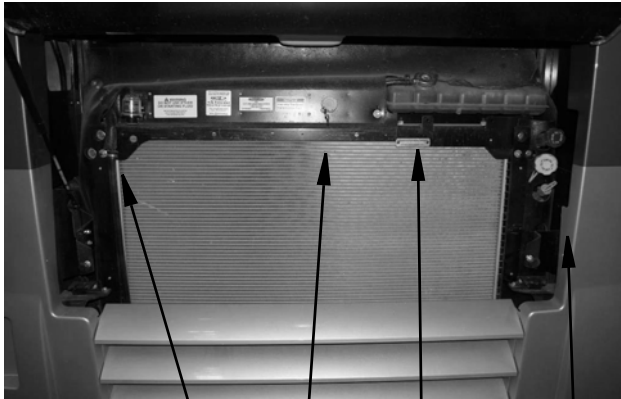

Air Filter Restriction Indicator Engine Coolant Reservoir
Engine Diagnostic Connector Engine Oil and Transmission Fluid

With the grille panel open, you can access the following service points:

- Engine Oil Dipstick
- Engine Oil Fill Cap
- Power Steering Reservoir
- Radiator Cap
- Engine Coolant Reservoir
- Transmission Dipstick/Fill Tube
- Air Filter Restriction Indicator
- Engine Diagnostic Connector



Power Steering Fluid Reservoir in recessed area at LH side of rear engine service compartment



Transmission Fluid Fill/Dipstick Engine Oil Fill Engine Oil Dipstick

ENGINE TOP ACCESS COVERS – REAR

These covers are only removed if a complete view of the engine is needed for inspection, or for replacement or adjustment of upper engine parts.

The engine top covers are located beneath the rear bed and wardrobe, depending on model.

Take precautions to protect carpet and interior furnishings when removing engine covers. The undersides of the engine covers could contain deposits of oil and fuel or other engine fluids and substances that could damage fabrics and interior furnishings.

Models with “North-South” Beds (Lengthwise to Coach)

- Remove the mattress from the bed and set aside in another area of the coach.
- Remove the screws that fasten the foot end of the bed board down to the bed base. (Note: If bed is designed for storage below bed board, these screws will not be present).
- Lift the hinged bed board upward against wall. Support the bed board with a suitable prop item as shown.

A falling bed board can injure. Assure the bed is properly supported. Refer to instructions for propping the bed board.

- Remove fasteners from metal engine covers and set covers aside.

Models with “East-West” Beds (Crosswise to Coach)

- Remove the mattress from the bed and set aside in another area of the coach.
- Remove the screws that fasten the foot end of the bed board down to the bed base. (Note: If bed is designed for storage below bed board, these screws will not be present).
- Lift the hinged bed board upward against wall. Support the bed board with a suitable prop item as shown.

A falling bed board can injure. Assure the bed is properly supported. Refer to instructions for propping the bed board.

- Remove the screws that fasten the wardrobe steps beside the bed, then remove the step cover and set aside.
- Remove fasteners from metal engine covers and set covers aside.

Removing Step Cover

When taking off the step cover, there are screws that need to be removed. These screws are found by feeling around the top edge of the step cover carpet (approximately two on each side).

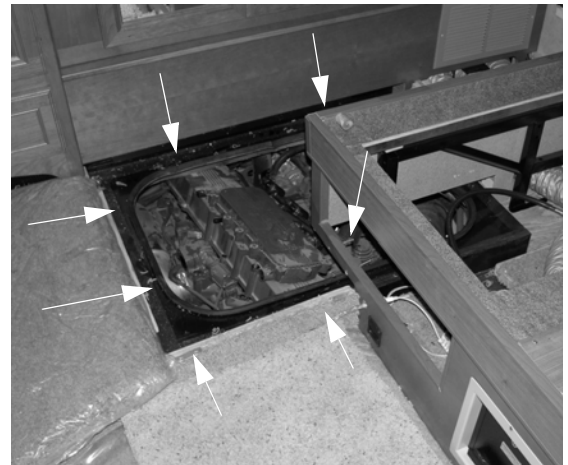

Step Cover Screw Locations
-Typical View

If your bed board is equipped with a front panel, there are two screws that need to be removed in order to take off the step cover (after panel is removed). See below photo.

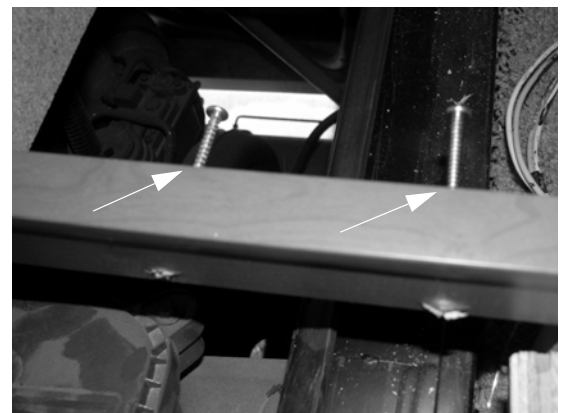

Remove two screws attaching bed board frame to step cover - located below panel
-Typical View

If your bed is not equipped with storage underneath and the bed board needs to be propped in order to access the engine, in some models you may need to remove the steel frame located underneath the bed in order to remove the carpeted step cover.

Propping the Bed Board

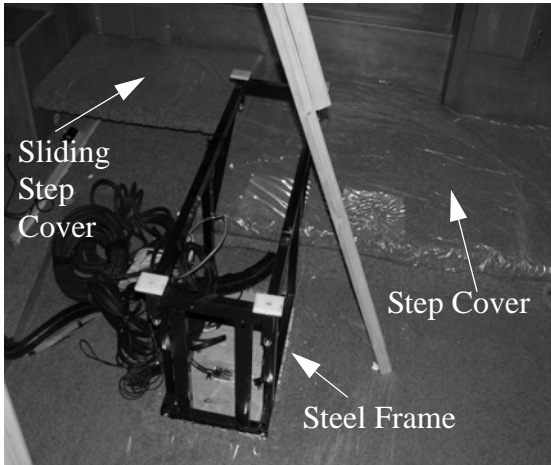

-Typical View

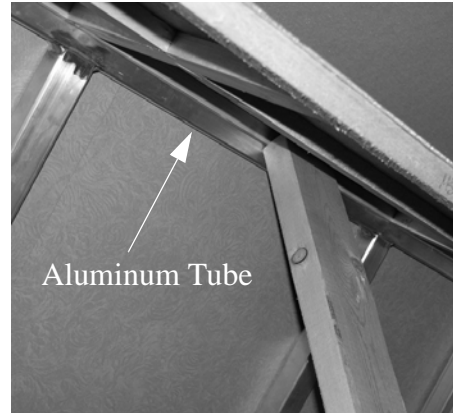

Steel Frame Screw Locations
-Typical View

NOTE: When supporting the bed with a suitable prop item (e.g. 6-ft. long 2x4 board), make sure that the top of the board is seated firmly against the aluminum tube at the top of the bed board and make sure the bottom of the board is seated firmly against the steel frame on the floor for security.

ENGINE TOP ACCESS COVERS – REAR BATH MODELS

These covers are only removed if a complete view of the engine is needed for inspection, or for replacement or adjustment of upper engine parts.

The engine top covers are located beneath the rear bath floor and lavatory cabinet, depending on model.

Take precautions to protect carpet and interior furnishings when removing engine covers. The undersides of the engine covers could contain

deposits of oil and fuel or other engine fluids and substances that could damage fabrics and interior furnishings.

1. Remove bathroom rug to access rear engine covers.



2. Using the engine access cover key (located on your key ring), unlock the middle engine cover lock by turning counter-clockwise.



Rear Engine Access Cover Lock

3. Remove unlocked engine access cover by grasping the two silver engine cover handles and pulling the cover up and out towards you. Remove and set aside.

NOTE: Use care when removing the engine access cover to avoid any possible interior damage.



4. Remove fasteners from the secondary black metal engine cover and set cover aside. You have now accessed the engine.
5. Reverse steps to reinstall rear engine covers, making sure to lock the middle engine cover lock by turning key clockwise.

Engine Top Access Cover (Beneath Lavatory Cabinet)

In some cases, you may need further access of the rear engine (beyond removing the engine access cover under the bathroom rug). A secondary engine access cover is located beneath the lavatory cabinet.

1. Remove white access panels below lavatory cabinet and set aside.

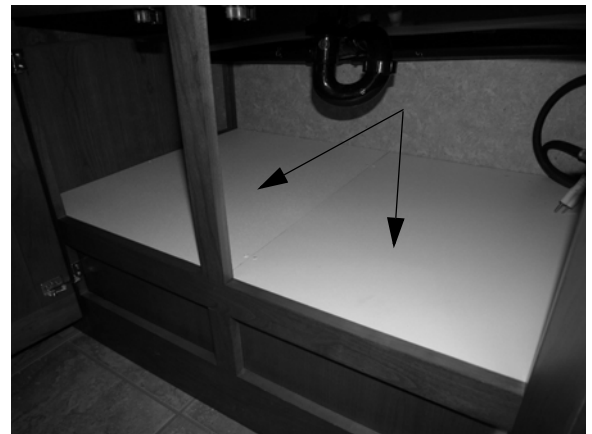

Access Panels
(Located below lavatory cabinet)

SECTION 3 – DRIVING YOUR MOTOR HOME

TOUR

2. Remove fasteners from the black metal engine cover (one located on each corner of the cover) and set cover aside. You have now accessed the engine.

NOTE: Removal of the cabinet face is required to take the engine cover out and set aside.

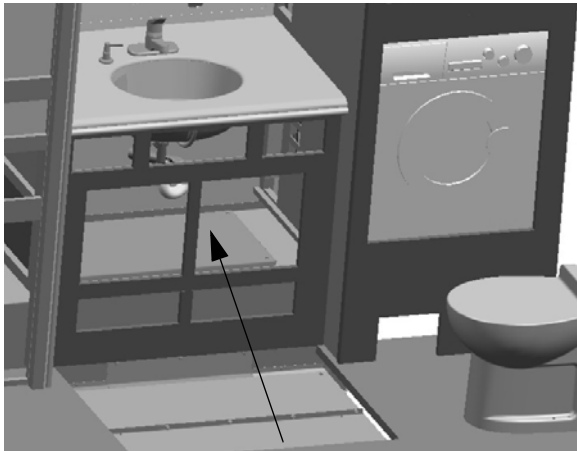

Engine Access Cover
(Shown with access panels removed)

3. Reverse steps to reinstall rear engine cover, cabinet face, and access panels.

FUEL/WATER SEPARATOR – DIESEL

Freightliner® Chassis

Diesel fuel often contains small quantities of water which can damage the engine if not filtered out. The fuel/water separator traps this water and prevents it from reaching the engine. The harmful water deposits must be drained from the separator canister during normal periodic service and maintenance to keep the fuel filtration system working effectively.

The fuel/water separator is located at the forward right side of the engine beneath the rear of the chassis.

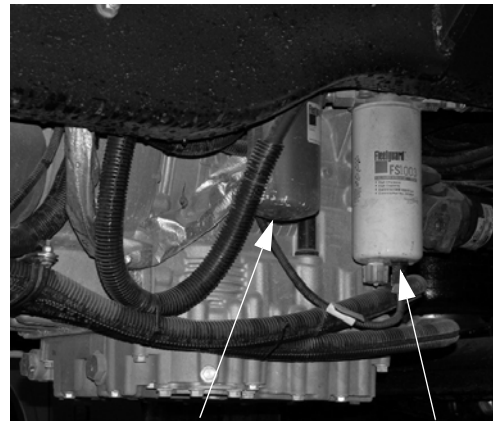

Engine Oil Filter (Typical) Diesel Fuel/Water Separator Filter (Typical)

(View beneath right side rear of chassis)

Place an appropriate container beneath the outlet and open the water release valve several turns. Drain any water deposits from the canister until clean diesel fuel flows from the valve. Close valve by hand. Do not over tighten.



Detail of drain valve on bottom end of fuel/water separator

- Turn counter-clockwise (left) to open
- Turn clockwise (right) to close

Dispose of the drained liquid in an environmentally responsible manner, such as taking to a waste oil disposal center.

ENGINE COOLING SYSTEM

Do not remove the radiator cap while engine and radiator are still hot. Always check coolant level visually at the see-through coolant reservoir.

*NOTE: Your chassis engine cooling system is filled with special extended-life coolant that is not the same as common anti-freeze available at retail outlets. The coolant system **MUST** be refilled or topped up with the same type of coolant as equipped to maintain the special long-life properties.*

NOTICE

When refilling the coolant system of a vehicle equipped with a rear auxiliary automotive heater and motoraid water heater, be sure to allow for additional coolant capacity of the heater and its supply and return hoses.

Further Information

Refer to the chassis manual in your InfoCase for information and precautions on filling, servicing, and checking the fluid level.

CHASSIS BATTERY DISCONNECT SWITCH

The chassis battery disconnect switch disconnects most chassis electrical loads from the chassis (starting) batteries to avoid discharge by constant draws such as engine computers, radio clock, sensors, etc. (except the electric entrance step). This feature is intended to help conserve battery charge during storage.



Chassis Battery Disconnect Switch
(Located near entrance door)
-Typical View

Turn the switch to the OFF or ON positions to disconnect or reconnect the chassis batteries.

NOTE: The chassis battery disconnect switch must be on to start the engine.

CIRCUIT BREAKERS AND FUSES – CHASSIS/DASH AUTOMOTIVE 12-VOLT

The fuses, breakers, and relays for automotive chassis and dash features are conveniently located on the main 12-volt electrical panel in the front left exterior compartment.

The circuit breakers pop outward if they are tripped. Simply push in to reset.

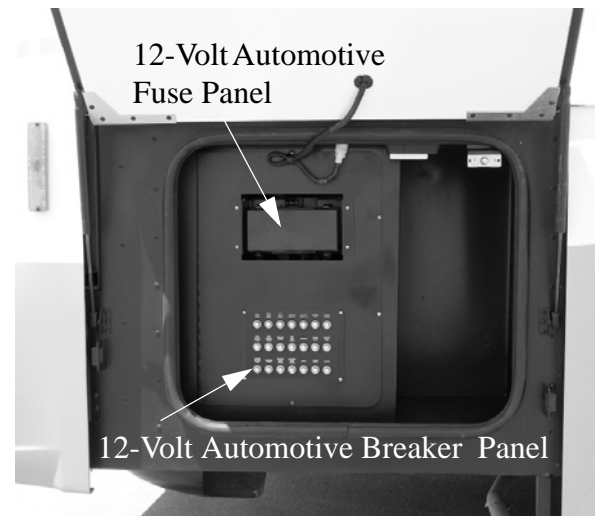

Automotive Circuit Breakers - push to reset
(Breakers are labeled for components equipped)

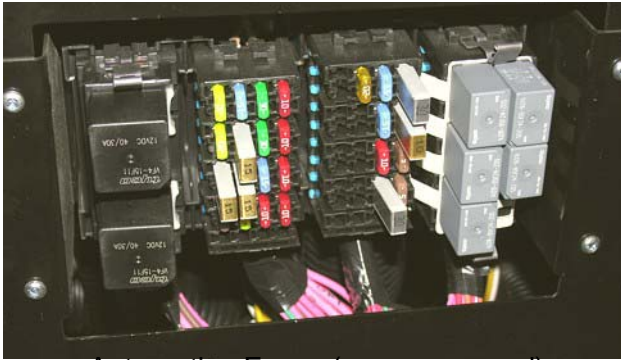

Automotive Fuses (cover removed)

Always replace plug-in type fuses with those of the same amperage size.

See the chassis manufacturer's fuse allocation chart on the inside of the fuse block cover.



Fuse Diagram (inside of cover)

Further Information

See your chassis manual in your InfoCase for further information about chassis supplied fuses and relays.

FRONT SERVICE ACCESS (HOOD)

The "hood" panel can be opened for access to the air hose connector and service items such as filling windshield washer fluid reservoir and checking generator oil.



Hood Latch
(Located in 12-volt electrical compartment)
-Typical View



Pull top of latch outward to release hood panel. Gas props will allow the top of the hood panel to swing outward and lower slowly until fully open. Close hood gently and push top of hood inward firmly with both palms outstretched to latch.

WINDSHIELD WASHERS AND WIPERS

The windshield washer fluid reservoir is located in the front of the coach behind the "hood" panel. A long-necked funnel may be required for filling.

We recommend using commercially available premixed solutions for best results. Do not use water in freezing temperatures because the washer pump could become damaged.



Windshield Washer Reservoir
(Located behind front hood panel)

-Typical View

TIRES

Improper tire pressure can result in tire overloading and abnormal wear and also affects handling, ride characteristics, and fuel economy.

	<h2>WARNING</h2>
<p>Make sure all replacement tires are of the same size and rating as those shown on your Vehicle Certification Label.</p>	

SUSPENSION ALIGNMENT AND TIRE BALANCE

The front suspension and steering system of this vehicle was factory aligned using highly accurate equipment prior to delivery to the dealership. However, alignment should be checked and adjusted after you have fully loaded the motor home according to your personal needs. Thereafter, the alignment should be periodically inspected to help prevent uneven tire wear.

Any excessive or abnormal tire wear may indicate worn or misaligned suspension or steering, unbalanced tire, or other tire/suspension problem.

Alignment can be affected by worn steering/suspension parts or by incidents which happen during driving, such as hitting a curb, pothole, or railroad track, etc. Improper alignment can cause tires to roll at an angle and wear unevenly. It may also cause the vehicle to “pull” to the right or left. Have your dealer inspect your vehicle’s suspension and steering components periodically for misalignment or wear.

Out-of-balance tires will not roll smoothly and can lead to vibrations and uneven tread wear, such as cupping and flat spots. Tires may need to be balanced if uneven wear is detected or if ride comfort decreases noticeably.

Further Information

See the chassis manual in your InfoCase for further information.

LIGHTS

All exterior lights should be checked for proper operation each time the vehicle is prepared for a trip. Any bulbs which fail to light should be checked and replaced, when necessary, with a new bulb of the same size. A failure of more than one light, such as both taillights not operating, may indicate a burned out fuse. Check fuse and replace with one of the same rating when necessary. If a fuse is not the cause of the problem, the wiring system should be checked immediately by an authorized service center.

Further Information

Refer to the chassis manual in your InfoCase for further information.

MOUNTAIN DRIVING

Special techniques must be used when driving in mountainous or hilly country.

Climbing A Hill

The transmission will automatically downshift as needed to climb most hills. If the hill is long or very steep, however, you may need to manually shift to a lower gear to keep the transmission from repeatedly upshifting and

downshifting. Select the lowest adequate gear range for the duration of the incline. See your chassis manual for specific information.

Descending A Hill

When going down a long grade, you may need to manually shift to a lower gear rather than keeping your foot on the brake pedal. A lower gear will allow the engine to provide a degree of braking action. Holding your foot on the brake pedal for an extended period may cause brakes to overheat, which could cause brake failure. See your chassis manual for specific information.

TOUR

SECTION 4 – APPLIANCES AND SYSTEMS

The appliances installed in your motor home are manufactured by reputable RV appliance makers and have been tested by independent laboratories to meet all applicable standards and codes set for RV appliances.

See Section 2 of this manual for any safety and precautions you need to take regarding the operation of your appliances.

REFRIGERATOR

The refrigerator in your coach can operate from either of two energy sources available to the motor home:

- 120-Volt AC electric
- Propane gas

To be able to use both types of energy, the refrigerator does not have a compressor like household refrigerators. Instead, it uses an ammonia-water solution for cooling. Basically, ammonia vapor is distilled from the solution by heat produced from either propane gas flame or electrical heat element. The ammonia vapor is then carried to the finned condenser where it liquefies. The liquid then flows to an evaporator where it creates cooling by evaporation. The ammonia circulates back into the water solution and the cooling cycle continues.

Leveling

Before operating the refrigerator when the motor home is stationary, place a small level on the bottom of the refrigerator and make certain the unit is level. If over 1/2 of the bubble is inside the circle in any direction, the coach is level enough for continuous operation of the refrigerator while parked.



Place bubble level in bottom of refrigerator

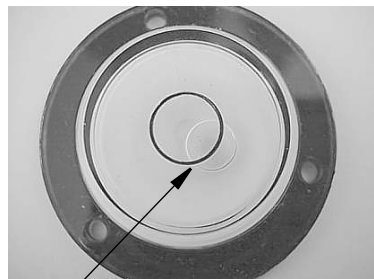

Bubble must be at least 1/2 inside circle

Normal vehicle leveling to provide comfort for the occupants is satisfactory for refrigerator operation.

NOTICE

To prevent permanent damage to the refrigerator cooling unit, turn the refrigerator off if the vehicle will be parked on an incline of over 3° side-to-side or 6° front-to-rear (such as steep driveways or parking lots, etc.) for more than one hour.

Basic Operation (Norcold®)

- Press the **ON/OFF** button to start the refrigerator.
- If the display code reads “**no**” there is no electricity or gas available to operate the refrigerator. Open the propane tank valve or connect the shoreline.



- Press the **MODE** button to select energy source. There are three settings:
LP (Gas Mode) - Refrigerator will operate on gas from the propane tank if the main valve is open and the tank contains gas.
AC (Electric Mode) - Refrigerator will operate on 120-VAC household current if the shoreline is connected or the auxiliary generator is running.
AU (Automatic Mode) - Refrigerator will automatically start operating on 120-VAC household current if the shoreline is connected or the auxiliary generator is running. If electricity is lost, it will automatically switch over to LP gas operation if gas is available.

NOTE: To avoid discharging house batteries, turn the Inverter OFF or switch the refrigerator to GAS mode anytime you are running the refrigerator with the shoreline unplugged.

The refrigerator draws its electrical current through the inverter and not directly from the shoreline.

If the refrigerator is in ELECTRIC or AUTO mode, it will continue to draw power from house batteries through the inverter when the shoreline is unplugged unless the Inverter is turned OFF.

- Press the **SET TEMP** button to change temperature setting from 1 to 9 on display. Start at the coldest setting to ensure coldest temperature in the freezer compartment, then adjust warmer as necessary after cold* food has been added.
**The refrigerator will retain temperature more efficiently if food is already cold before placing inside.*

Basic Operation (Dometic® “Sidewise”)

-If Equipped



- To start up the refrigerator, press the main power ON/OFF button.
- Set clock when display panel shows horizontal bars (- - -).
- To enter TIME MODE, keep SET key pressed until figures flash on the display panel. Hours are to the left and minutes are to the right.
- Press SET key to adjust to local time. AM or PM should also be set here.
- Store each setting by pressing AUTO/STORE key or use the automatic store function (wait 5 seconds).
- To set the thermostat range, press the SET button to the desired setting (1 to 5, with 5 being the coldest.) Store by pressing the AUTO/STORE button or use the automatic store function (wait 5 seconds).
- To select energy mode of operation, press the AUTO/STORE button to select Auto mode operation or locked up to LP-Gas mode operation only.

NOTE: Current mode of operation and energy source (AC or GAS) is indicated by a dot on the LED panel.

Further Information

For further information and operating cautions, see the refrigerator operating instructions included in your InfoCase.

ICE MAKER

-If Equipped

Some refrigerators are equipped with an automatic ice maker system. The ice maker unit is installed in the freezer compartment of the refrigerator.

NOTE: A water shut-off valve for the ice maker is located near the water faucet filter inside the galley cabinet beneath the sink.

Further Information

See the refrigerator manufacturer's operation, care and maintenance information in your InfoCase.

REFRIGERATOR SERVICE ACCESS COMPARTMENT (Exterior)

The exterior refrigerator service compartment allows access to the rear of the refrigerator for inspection, maintenance and service.

To Open:

1. Use a screwdriver or coin to turn the latch knobs to the vertical position as shown.



Refrigerator Access Door Latches

2. Remove the door from the opening.

To Close:

1. Replace the door into the opening.
2. Push the latch knobs in while turning to the horizontal position as shown.

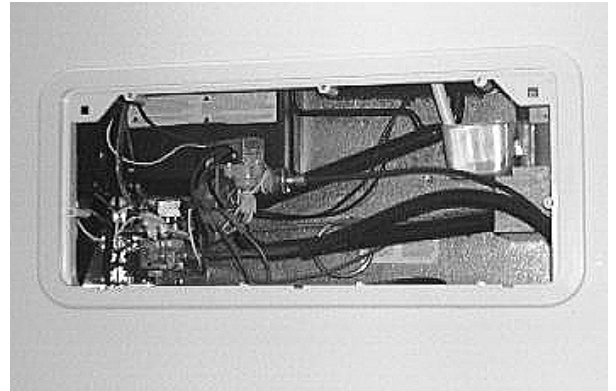

Refrigerator Access Compartment

REFRIGERATOR/FREEZER - PORTABLE

-If Equipped

Your coach may be equipped with a 120-volt AC/12-volt DC portable refrigerator/freezer, which is mounted on a slide tray in a passenger side storage compartment.

- To pull out the refrigerator/freezer unit for easier access, pull up on the locking mechanism (located on the bottom left) to release slide tray.

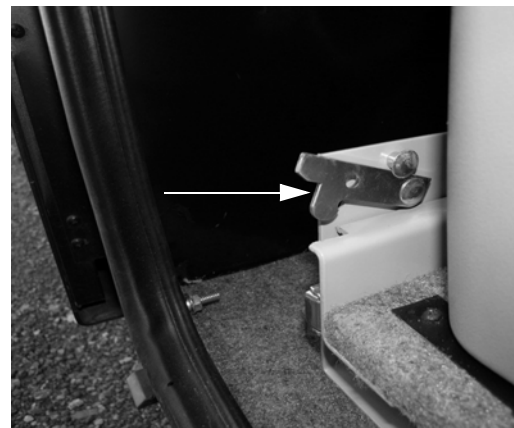

- Pull the slide tray out.



Removing Refrigerator/Freezer Unit from Slide Tray

1. To remove refrigerator/freezer unit from slide tray, disconnect the 12-volt power cable and the electrical plug from the energy source located inside the compartment.

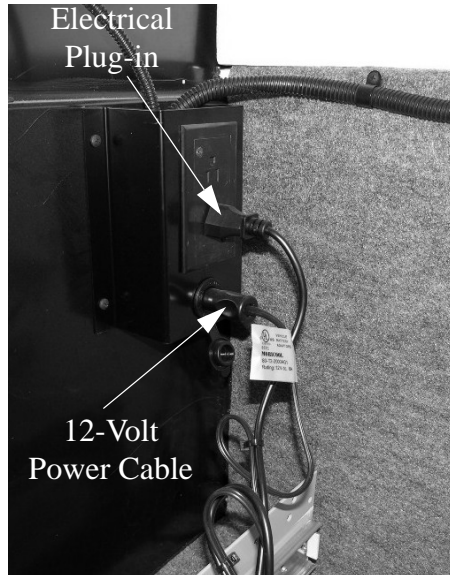

Refrigerator/Freezer Energy Source
(Located inside of compartment behind refrigerator/freezer unit)

2. Remove fasteners from metal support brackets and lift refrigerator/freezer unit off of slide tray.



Further Information

See the manufacturer's user guide provided in your InfoCase for complete operating instructions and cautions.

RANGE TOP

The range in your motor home operates on propane gas and will provide most of the functions of the range in your home.



To Light Range Top Burners

- Push the desired control knob and turn to HI LITE position.

NOTE: The burners on this appliance have fixed aeration and no adjustment is required.

Avoiding Asphyxiation

The following warning label has been located in the cooking area to remind you to provide an adequate supply of fresh air for combustion.

⚠ WARNING

**IT IS NOT SAFE TO USE
COOKING APPLIANCES
FOR COMFORT HEATING**

Cooking appliances need fresh air for safe operation. Before operation

1. Open overhead vent or turn on exhaust fan.
2. Open window

**FAILURE TO COMPLY COULD RESULT IN
DEATH OR SERIOUS INJURY.**

Unlike homes, the amount of oxygen supply is limited due to the size of the recreational vehicle, and proper ventilation when using the cooking appliances avoids dangers of asphyxiation.

It is especially important that cooking appliances not be used for comfort heating, as the danger of asphyxiation is greater when the appliance is used for long periods of time.

**FAILURE TO COMPLY COULD RESULT
IN DEATH OR SERIOUS INJURY.**



WARNING

Portable fuel-burning equipment including wood and charcoal grills and stoves, shall not be used inside the recreational vehicle. The use of this equipment inside the recreational vehicle can cause fires or asphyxiation. Failure to comply could result in death or serious injury.

The range top is featured with a hinged glass cover, which folds down for convenience.

To Fold Range Cover Down

- Lift cover and release the metal peg (located on the right-hand side of the cover) by pulling straight out.



- Fold the top half of the range cover down.



To Close Range Cover

- To close range cover, lift up on the bottom of the hinged glass cover. The metal peg will automatically “click” into locked position.



- Lower the range cover so it is flush with the countertop.

NOTICE

Turn off the range and allow it to cool before closing the range cover. The range cover is made of glass and may shatter when heated.

Further Information

See the appliance manufacturer’s operation manual in your InfoCase for complete range features, operating instructions, and safety precautions.

MICROWAVE OVEN/RANGE HOOD

The range hood vent is built into the microwave oven. The range hood fan carries cooking odors and gas fumes to the outside of the coach. A light on the underside of the hood provides illumination for food preparation. The hood fan and light switches are located on the microwave control panel.



Microwave/Range Hood - Typical (brand, model, and appearance shown may vary from your model)

Further Information

See the manufacturer’s information in your InfoCase for microwave operating instructions and replacement of vent hood light bulbs and replacement or cleaning of grease filter elements.

**ONEPLACE® SYSTEMS
MONITOR PANEL**

The OnePlace Systems Monitor Panel provides a convenient, central location for checking the condition of all utility systems in your coach. It also includes the TrueAir® climate control thermostat and the PowerLine® Energy Management System status panel.



OnePlace Monitor Panel
-Typical View

At the touch of a button this panel can display the fresh water and holding tank levels, propane gas tank level, plus the chassis battery and house battery condition. You can start the electric generator or turn on the water pump and water heater. Indicator lights tell you if the water pump is on or if the water heater pilot light is out.

Generator Start/Stop Switch

See Electrical Systems section for generator start-up and shut-down instructions.

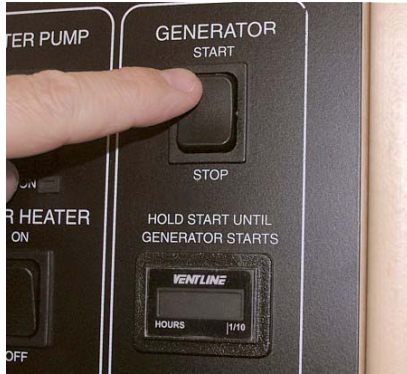

Generator Switch and Hourmeter
-Typical View

Generator Hourmeter

See Electrical Systems section for generator hourmeter information.

Water and Holding Tank Levels

Press and Hold the appropriate button to show approximate tank level on the monitor lights.



-Typical View

The approximate fluid levels are measured by sets of electronic sensors (detector cells) on the sides of the tanks. There is generally more fluid in a tank than indicated on the monitor panel.

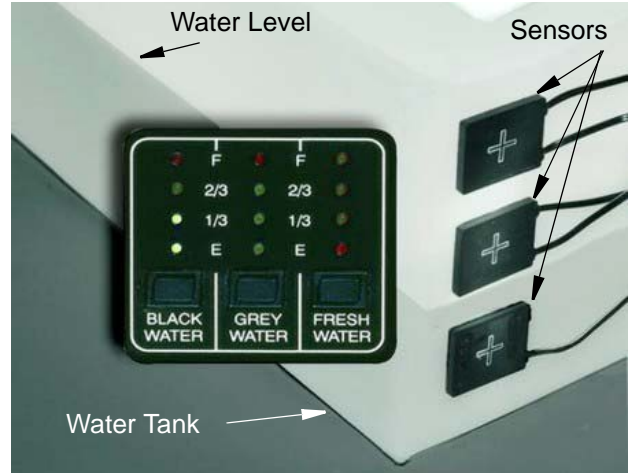

For example, if the fluid level is 1-2” below the FULL sensor, the monitor will show the level to be only 2/3 even though the tank is nearly full.

If a tank is about 1/4 full, the monitor will register an empty tank because the fluid level is below the 1/3 sensor even though there is still fluid in the tank.

However, when the indicator reads FULL, the tank is actually full.

For your convenience there is also a tank monitor panel in the water service center compartment.



Water Center Tank Level Monitor
-Typical View

Tank Capacities

See Section 1 - Tank Capacities.

Propane Gas Level

Press and hold the “LP GAS” button to show approximate propane tank level.

The propane level is registered by a sending unit on the tank. The gauge mounted on the side of the tank will give a more accurate indication of actual tank level if needed.

Water Pump Switch

When you want to use the self-contained water system, turn on the “Water Pump” switch on the monitor panel. The “Pump On” light will illuminate when the pump switch is turned on. Water will be available as soon as a faucet is opened.

For your convenience, a switch is also located in the water center compartment.

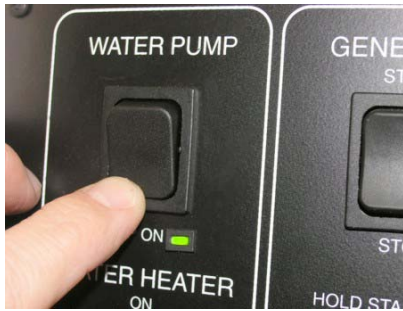

Water Pump Switch
-Typical View

Battery Voltage Meter

Press the “House Battery” switch position to check the level of charge (voltage) in the 12-volt house batteries.

Press the “Engine Battery” position to check chassis battery charge.

To get an accurate reading;

1. Both the chassis engine and the generator engine must be shut off.
2. An interior light should be turned on to provide a small load which draws off the battery surface charge.



-Typical View

The LCD display will show the current battery voltage to the nearest tenth of a volt.

- A 12-volt battery typically registers anywhere from 12.5V to 13V when adequately charged.
- Voltage below 12V indicates a moderately discharged condition; 11.5V or less is extremely discharged.
- Voltage above 13V typically indicates that the battery is being charged by the inverter charger system.

SOLAR CHARGER PANEL

The 10-watt roof-mounted solar charger panel uses the sun to help keep your house batteries charged. A charge indicator light is provided on the OnePlace® panel to show you when the solar panel is actively charging the house batteries.

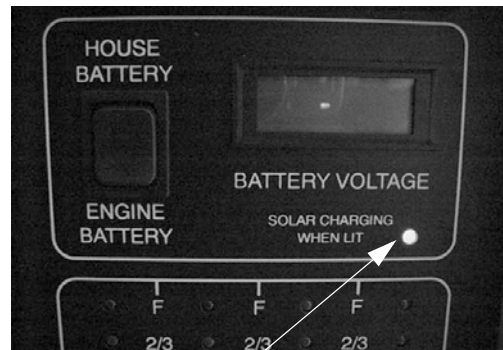

Solar Charging Indicator

- Glows when charging
- Full glow means maximum charge rate
- Gradually dims as batteries charge
- Goes off when batteries fully charged

NOTE: The solar battery charger is not intended to make the coach battery system “maintenance free.” The solar panel will not completely compensate for continuous low amperage draw from components such as the propane gas leak detector, the clock in the dash radio and the radio station memory circuitry, for example.

Although the solar panel system can help to extend battery life, the coach shoreline should be plugged in routinely to “top off” the batteries. We also recommend following regular battery inspection and maintenance, especially in cold weather. See “Battery Care” in Electrical section.

The solar panel circuit breaker is located in the shoreline cord compartment.



ENERGY MANAGEMENT SYSTEM (EMS)

–If Equipped

The Energy Management System (EMS) monitors the electrical usage of the appliances and equipment in the coach and allows you to use certain high energy appliances, such as the microwave or washer/dryer, without overloading the shoreline circuit breaker to prevent nuisance tripping.



EMS Display Panel
(Located on Monitor Panel)
-Typical View

Further Information

Please read the Energy Management System Owners Guide in your InfoCase for important information on how this system operates under several conditions, whether 20-amp, 30-amp, and 50-amp connections, or generator service. In 50-amp service, the load meter is blank. In all other conditions, the load meter displays actual current load.

ENERGY MANAGEMENT SYSTEM (EMS)

–If Equipped (Model 42AD only)

The Energy Management System (EMS) monitors the electrical usage of the appliances and equipment in the coach and allows you to use certain high energy appliances, such as the microwave or washer/dryer, without overloading the shoreline circuit breaker to prevent nuisance tripping.



EMS Display Panel
(Located on Monitor Panel)
-Typical View

Further Information

Please read the Energy Management System Owners Guide in your InfoCase for important information on how this system operates under several conditions, whether 20-amp, 30-amp, or 50-amp connections.

WATER HEATER - GAS/ ELECTRIC

**-If Equipped
(with Motoraid water heating system)**

*** NOT AVAILABLE ON COACHES
EQUIPPED WITH HYDRONIC HEATING
SYSTEM**

The gas/electric water heater has a dual power feature. It can operate from propane gas or 120-volt house current; or it can use both at the same time for quicker recovery at times when you are using a lot of hot water.

Read the Water Heater Operation Manual for complete Safety Warnings, Operating Instructions and Maintenance Information before operating the water heater.

Be sure the water heater is filled with water before starting either electric or propane gas operation. To fill the water heater, turn the Water Pump switch on and open a hot water faucet anywhere in the coach. When water begins to flow steadily from the faucet, the water heater is full.

For Propane Gas Operation

Press the Water Heater switch on the Monitor Panel. The “Pilot Out” light will glow for about 10-15 seconds, then it will go out. The “Heater On” indicator will remain lit. If the “Pilot Out” light comes on during gas operation, it means that the burner has gone into “lockout” mode and must be restarted. If this happens, turn the Water Heater switch off for about 5 minutes, then turn it back on.



Gas Water Heater Switch
(Located on monitor panel)

For Electric Operation

Turn on the Water Heater electric element switch. The shoreline must be connected or generator running for electric operation.



Electric Water Heater Switch
(Located near monitor panel)

For Quick Recovery Operation (Dual Heating)

Turn On both Water Heater switches; the gas one on the monitor panel and the electric one. This will help reheat the water heater tank more quickly than a single source would alone. Use this mode when you are using a larger than normal volume of hot water.

Further Information

Read the operating and safety information provided in the Water Heater Operation Manual in your InfoCase.

PRESSURE-TEMPERATURE RELIEF VALVE

*** NOT AVAILABLE ON COACHES
EQUIPPED WITH HYDRONIC HEATING
SYSTEM**

On occasion, water may be seen seeping from the water heater pressure temperature relief valve. This is no cause for repair or replacement of the valve.

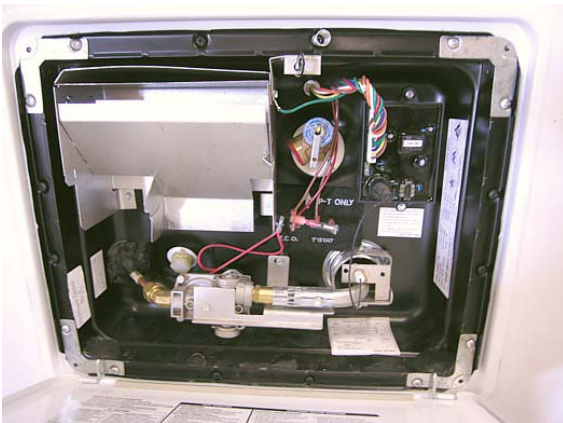

Water Heater Exterior Service Access

Normally there is an air gap at the top of the water heater tank, which acts as a pressure buffer. In time, however, heated water may expand and fill this air gap, causing a slight increase in water pressure. This may cause the P-T valve to “weep” until the air gap is manually replaced.



CAUTION

Hot water can escape from tank causing injury. Operate this valve only when the water heater and engine cooling system are cold.

To Replace the Air Gap:

1. Turn off the Water Heater switch and incoming water supply (city water and/or demand pump).
2. Open a faucet in the motor home to relieve water pressure.
3. Pull the handle of the P-T valve straight out and allow water to flow until it stops.

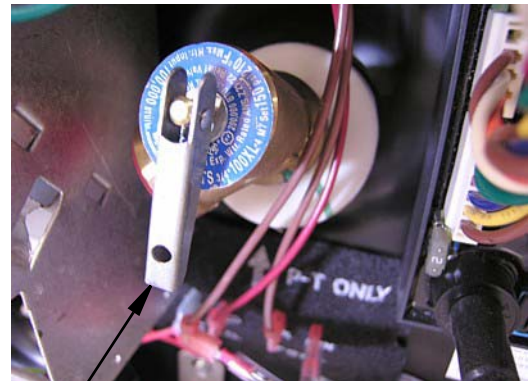

Lift handle straight out to open P-T valve when water heater is cold*

4. Let the handle of the P-T valve snap shut.
5. Close the faucet and turn on the water supply before switching the water heater on.

Manually operate the pressure temperature relief valve at least once a year.

NOTE: If your water heater is equipped with the motoraid system, it uses an extension from the engine cooling system to heat water in the water heater while driving. The engine cooling system must also be cold before opening the pressure-temperature relief valve. See “Motoraid Water Heater” for more information.

MOTORAID WATER HEATER

–If Equipped

*** NOT AVAILABLE ON COACHES
EQUIPPED WITH HYDRONIC HEATING
SYSTEM**

The motoraid uses heat from the chassis engine cooling system to heat water in the water heater while driving. Hoses are routed from the engine to a heat exchanger surrounding the water heater tank.

Under normal conditions, the entire contents of the water heater can be heated in about two hours or 100 miles of driving. This means you can have hot water at the faucets immediately upon arriving at a site.

The motoraid also increases the capacity of the engine cooling system.

NOTICE

Any leak in the heat exchanger or its supply or return lines could cause loss of coolant and subsequent engine failure. We recommend that you periodically inspect these connecting lines and the heater to insure that no leaks have developed.

PROPANE GAS FURNACE

*** NOT AVAILABLE ON COACHES
EQUIPPED WITH HYDRONIC HEATING
SYSTEM**

To Start Up:

1. Open the LP gas tank valve by turning fully counter-clockwise.

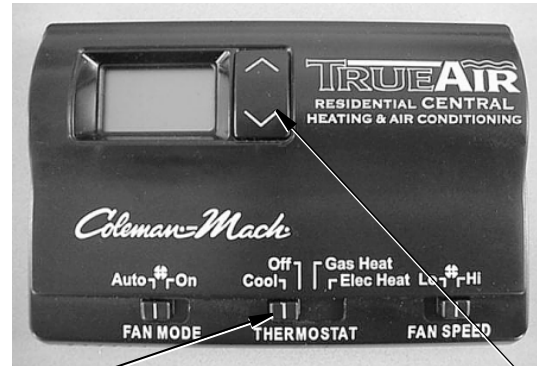

Thermostat Switch
• Move to Heat or Gas position for furnace operation

Temp Selector
• Press up or down to select temperature

2. Move THERMOSTAT switch from Off to Heat and press the Temp Selector button (Up/Down arrows) until the desired temperature is shown in the display.
3. Furnace fan should start to blow immediately after setting the thermostat.
4. After about 30 seconds, the furnace burner should light.
5. The furnace should now cycle off and on automatically as the thermostat demands just like a household furnace.

NOTE: If heat does not come out of the heat ducts after a minute or so the burner is not lit.

Turn thermostat off for 3-5 minutes, check to be sure propane gas tank valve is open and tank is not empty, then try steps 2-4 again.

If the furnace will not light after three attempts, go to Shut Down steps and contact your dealer or a local RV service center for repair.

To Shut Down:

1. Slide thermostat switch to Off position.
2. Close propane tank valve if coach will be stored for a period of time.

Further Information

Please see the furnace operating instructions provided in your InfoCase for further information, including operating precautions,

and periodic maintenance. See the Coach Maintenance Schedule for recommended intervals.

NOTE: If the furnace burner has any residuals of metal protectant or lubricants used during manufacture of the furnace, it may smoke slightly when the furnace is used for the first time and may set off your smoke alarm.

We recommend that you provide adequate ventilation when using the furnace for the first time to avoid a nuisance smoke alarm.

We do not recommend removing the smoke alarm battery.

REAR FURNACE

–If Equipped

*** NOT AVAILABLE ON COACHES EQUIPPED WITH HYDRONIC HEATING SYSTEM**

The rear furnace is controlled by a separate thermostat located in the rear of the coach.

To Start Up:

1. Open the LP gas tank valve by turning fully counter-clockwise.
2. Move the Thermostat/Switch to from OFF to the desired temperature position.



- Thermostat/Switch
- Move from OFF to desired temperature for furnace operation
- Room Temperature Thermometer

3. Furnace fan should start to blow immediately after setting the thermostat.
4. After about 30 seconds, the furnace burner should light.
5. The furnace should now cycle off and on automatically as the thermostat demands just like a household furnace.

NOTE: If heat does not come out of the heat ducts after a minute or so the burner is not lit.

Turn thermostat off for 3-5 minutes, check to be sure propane gas tank valve is open and tank is not empty, then try steps 2-4 again.

If the furnace will not light after three attempts, go to Shut Down steps and contact your dealer or a local RV service center for repair.

To Shut Down:

1. Move thermostat switch to OFF position.
2. Close propane tank valve if coach will be stored for a period of time.

Further Information

Please see the furnace operating instructions provided in your InfoCase for further information, including operating precautions, and periodic maintenance. See the Coach Maintenance Schedule for recommended intervals.

NOTE: If the furnace burner has any residuals of metal protectant or lubricants used during manufacture of the furnace, it may smoke slightly when the furnace is used for the first time and may set off your smoke alarm.

We recommend that you provide adequate ventilation when using the furnace for the first time to avoid a nuisance smoke alarm.

We do not recommend removing the smoke alarm battery.

ELECTRONIC THERMOSTAT (Central Heat/Air Conditioning System)

The thermostat, located on the OnePlace® panel, controls heating, air conditioning, cooling fan and heat pump operation.

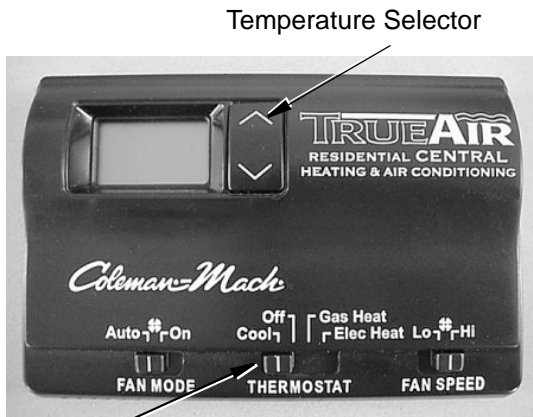

Temperature Selector

Thermostat (Source) Switch

COOL= Air Conditioning
ELEC = Heat Pump
GAS = Furnace

Central Air Thermostat

NOTE: The thermostat does not automatically switch between heating and cooling. You must place the thermostat switch in the desired position.

Heating

- Slide the thermostat switch to “Gas Heat” position.

NOTE: Follow proper furnace lighting procedures described previously in this section.

- Adjust the temperature setpoint to personal preference if needed. See “Changing Temperature Setpoints.”

Digital Thermostat Display

The digital display normally shows current room temperature, with the word “ROOM” in small letters at the left side of the display. When you press the temperature selector button up or down, the display will show the word “SET” and the new temperature setpoint until you release the button.

Changing Temperature Setpoints

To set the temperature to a new temperature, simply press the Temperature Selector button up or down until the temperature you want appears in the display. The word “SET” will also appear at the left side of the display while you are changing the temperature setpoint. A few seconds after you release the temperature selector button, the display will return to showing the current room temperature.

Cooling (A/C)

- Slide the thermostat switch to Cool position.
- Slide the Fan Mode and Fan Speed Switches to the desired positions.

On/Low: A/C compressor cycles on and off with the thermostat while fan runs continuously at low speed.

On/High: A/C compressor cycles on and off with the thermostat while fan runs continuously at high speed.

Auto/Low: Fan runs at low speed and cycles on and off with the A/C compressor as controlled by the thermostat.

Auto/High: Fan runs at high speed and cycles on and off with the A/C compressor as controlled by the thermostat.

- Adjust the temperature setpoint to personal preference if needed. See “Changing Temperature Setpoints”.

To Run Fan Only (No Heat or Air)

- Set Thermostat switch to OFF.
- Slide Fan Mode switch to On.
- Place Fan Speed switch to Lo or Hi as desired
- The fan will run continuously at the selected speed and is not controlled by thermostat setting. The display will show current room temperature.

ELECTRONIC THERMOSTAT - MODEL 42AD

(Heating and Cooling)

The thermostat (located near the monitor panel) controls the Hydronic Heating System, as well as the three separate roof air conditioners in your coach. The living area and galley are equipped with two air conditioners, and the bedroom and bath area is equipped with one.

When controlling the settings from the thermostat, you must manually press the “Zone” side of the Mode/Zone Button and set to your preference by toggling to either Zone 1, Zone 2, or both.

- ZONE 1 - (2) A/C Units in Living/Galley Area
- ZONE 2 - (1) A/C Unit in Bedroom/Bath Area

The thermostat system will operate in both heat and cool modes, but will not allow you to run both heat and cool modes simultaneously.

LCD Display Screen Setpoint Button



Thermostat Switch Mode/Zone
COOL = Air Conditioning Button
HEAT = Furnace

Electronic Thermostat
-Typical View



Zone 1 Operation
(Living Area/Galley)



Zone 2 Operation
(Bedroom/Bath)

NOTE: The thermostat does not automatically switch between heating and cooling. You must place the Thermostat Switch in the desired position.

Heating

1. Turn ON the Hydronic Heating System Interior Control Switch (either Diesel Burner or Electric Element, whichever you prefer to use). See the Hydronic Heating System information elsewhere in this section for further information.
2. Select Zone.
3. Slide the thermostat switch to the “Heat” position.
4. Press the “Mode” side of the Mode/Zone button and toggle between settings to select either “Gas Heat” (for Propane Furnace) or “Heat Elec” (for Heat Pump).

5. Adjust the temperature setpoint to personal preference if needed. See “Changing Temperature Setpoints.”

Cooling (A/C)

1. Select Zone.
2. Slide the thermostat switch to Cool position.
3. Press the “Mode” side of the Mode/Zone Button and toggle to your desired setting:
 - **Cool/Auto:** Allows the fan speed to vary depending on the cooling needs. This is the default setting.
 - **Cool High/Cool Low:** Sets the fan speed to run continuously at high or low, but the upper unit will cycle when cooling is needed.
 - **Fan High/Fan Low:** Sets the fan to run continuously at high or low speed. The upper cooling unit will not run to produce cooling. Setpoint is not adjustable in this mode.
 - **Off:** Turns the upper unit off for the zone displayed. By continuing to press the “Mode” button, you can toggle through the settings for the zone displayed until you have reached your desired setting. Setpoint is not adjustable in this mode.
4. Adjust the temperature setpoint to personal preference if needed. See “Changing Temperature Setpoints”.
5. Once you have established the settings for Zone 1, press the Zone Button to store settings in thermostat memory.

NOTE: Repeat steps for each zone.

Heat Pump

Your coach is equipped with an air source heat pump built into the air conditioning system. Because the heat pump operates on electricity, it provides economical heat inside your coach and helps reduce the use of propane gas for heating in cooler weather.

A heat pump can be thought of as an air conditioner running in reverse. An air conditioner absorbs heat from the air on the inside of the coach and moves it to the outside. The heat pump does exactly the opposite. Even cold air contains some heat, so a heat pump will

extract heat from the outside air on a cold day and carry it to the inside of the coach to maintain a comfortable temperature.

The efficiency of a heat pump decreases as the outdoor air temperature drops, so supplementary heat is often needed when the outside temperature nears freezing. This system is set to automatically start the propane furnace to assist the heat pump if room temperature cools to 5 degrees or more below the thermostat set temperature. You may wish to manually switch to propane furnace heat to maintain a higher temperature when outside temperatures begin to reduce the efficiency of the heat pump. The heat pump will not operate when the outside temperature falls below 36 degrees F.

To Run Fan Only (No Heat or Air)

1. Set Thermostat Switch to COOL.
2. Press the “Mode” side of the Mode/Zone Button.
3. Toggle between settings and select FAN HIGH/FAN LOW.
4. The fan will run continuously at the selected speed and is not controlled by thermostat setting. The display will show current room temperature.

LCD Thermostat Display

The LCD Display Screen displays a variety of features, including the room temperature and setpoint temperature. If the word “Set” is shown above the temperature, then the setpoint or desired temperature is shown. If the word “Set” is not shown, then the temperature shown is the actual room temperature.

Changing Temperature Setpoints

To change the temperature, press the up or down arrow once on the Setpoint Button. The word “Set” will appear on the display screen. This puts the system in the mode to change the setpoint temperature. Then, press the up or down arrow until you have reached your desired temperature.

NOTE: The temperature setpoint cannot be adjusted in the following situations: When the Thermostat Switch is set to OFF, when the zone is turned off for either heating or cooling mode, or when the fan is set to be running continuously in either high or low speed.

Supply and Return Air Vents

Your coach is equipped with Supply and Return Air Vents throughout the coach. Supply airflow comes from the vents located on the driver side of the coach. The Return Air Vents are located on the passenger side of the coach.

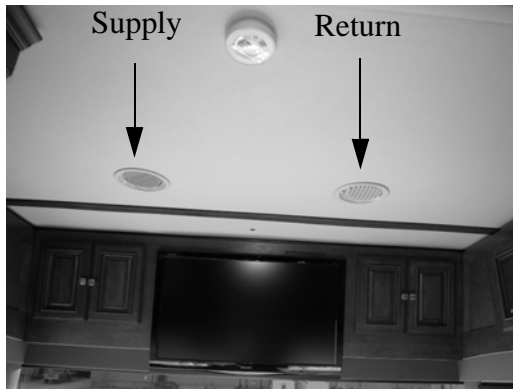

Supply/Return Air Vents

(Located throughout the ceiling of the coach)

- Supply Vents - Driver Side
- Return Vents - Passenger Side

Condensate Drain Lines

The three roof air conditioners are equipped with condensate water pumps, which allows water that is extracted from the roof air conditioners to be pumped through three separate drain lines (located at the rear of coach).

If you notice water running off of the roof when the air conditioners are running, this is a sign that one or more of the drain lines have plugged and water is now flowing out of the safety overflow of the air conditioner(s). See your Winnebago Industries® dealer for service and proper cleaning of the drain lines.

NOTICE

Water running off the roof is a sign the condensate drain lines are plugged and require service. Failure to comply may result in water damage to the roof.

Further Information

For complete operating instructions and troubleshooting procedures, see the manufacturer's user guide provided in your InfoCase.

HYDRONIC HEATING SYSTEM

-If Equipped

The hydronic heating system in your RV provides a continuous supply of hot water, interior heat, and engine preheating. This system features a 12-volt DC powered diesel burner (which utilizes on-board diesel fuel) and a 120-volt AC electric heating element, along with a propylene glycol-based antifreeze and water heating solution to give you the luxury of quiet, continuous warmth in your motor home.

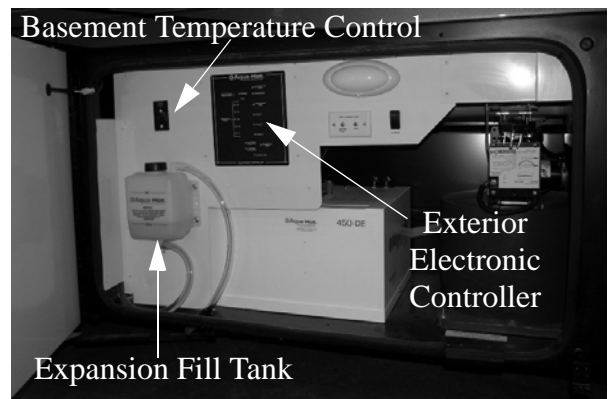

Hydronic Heating System

(Located in driver side compartment behind front wheel well)



Basement Temperature Control

NOTICE

When the water system is in use, the thermostat should never be set below 40-degrees F. to prevent freeze damage to components.

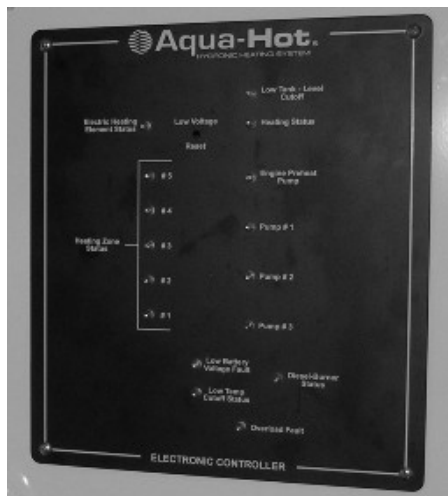

Exterior Electronic Controller

- Red and green lights indicate the status of your hydronic heating system. See manufacturer's operating manual for further information.

NOTE: If low voltage occurs, the hydronic heating system will shut down. Once the voltage level is restored, you must reset the system by turning OFF the diesel burner switch on the interior control

switch panel for approximately 30 seconds, then turning the switch back ON.



Expansion Fill Tank

- Check antifreeze/water heating solution level monthly. When the system is at maximum operating temperature (i.e. immediately after the diesel burner cycles OFF), the fluid level should be at the level marked HOT.
- If fluid level is low, see the Maintenance Section in the manufacturer's operating manual for replenishing the antifreeze/water heating solution.

NOTE: Use only Aqua-Hot® approved propylene glycol-based antifreeze.

Hot Water

The hydronic heating system allows water to be heated as it is being used. A continuous supply of hot water is obtained through a tankless, on-demand hot water system.

Interior Heat

This system is also equipped with circulation pumps, which allow individual interior heating zones. Whenever the room thermostat calls for heat, the water heating solution is circulated through interior heat exchangers (similar to radiators) located throughout your RV that distributes heat quietly and evenly.

- Zone 1 - Main Living Area
- Zone 2 - Bedroom and Bath(s)

- Zone 3 - Basement

Engine Preheating/Motoraid

Also included in this system is a motoraid feature, which uses heat generated by the RV engine during travel to transfer heat to the water heating solution in the boiler tank. This process allows the boiler tank to remain heated, which reduces the time required to bring the tank to operating temperature for continuous hot water and interior heat.

The hydronic heating system also includes an engine preheat feature. This allows for easy engine start-up whenever cold weather conditions exist.



Hydronic Heating System
Interior Control Switches
(near OnePlace® monitor panel)
-Typical View

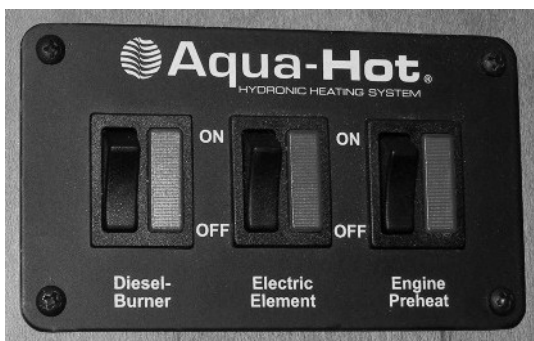

Interior Control Switches

The hydronic heating system can be operated off of the 120-volt AC electric heating element or the 12-volt DC diesel burner.

NOTE: Please note that the diesel burner is the primary heat source for heating both the interior and the domestic hot water (such as when cool ambient temperatures exist and/or when there is a high demand for domestic hot water).

It is recommended that when starting up your RV in extreme cold weather conditions or when you are planning on taking a longer shower, to turn on the diesel burner switch located on your interior control switch panel.

If you normally run the hydronic heating system off of the 120-volt AC electric heating element only, it is recommended to fire up the diesel burner monthly as routine maintenance.

Increasing and Decreasing Water Temperature

A tempering valve is located on the back side of the Aqua-Hot unit for regulating the temperature of the hot water.

Turning the tempering valve an 1/8 of a turn either way will dramatically increase or decrease the water temperature.



WARNING

Increasing water temperature may result in scalding and serious injury.

- Turn tempering valve COUNTER-CLOCKWISE to INCREASE water temperature.
- Turn tempering valve CLOCKWISE to DECREASE water temperature.



Hydronic Heating System
Tempering Valve
(Located on back side of
the Aqua-Hot unit)



Fuel Nozzle
-Typical View

See “*Winterizing Procedures*” in Section 7 - *Plumbing (METHOD 2 - ANTIFREEZE FILL PROCEDURE)* for complete instructions in winterizing your hydronic heating system. The Aqua-Hot will be winterized along with the rest of the RV water systems.

Changing the Fuel Filter and Fuel Nozzle

To keep the Aqua-Hot system running smoothly, it is recommended to have the diesel burner tuned up annually. This consists of replacing the fuel filter and the fuel nozzle. To ensure maximum performance, always replace with the fuel filter and fuel nozzle recommended for your Aqua-Hot system.

NOTICE

Do not blow out Aqua-Hot hydronic heating system. Failure to comply may result in system damage.

Further Information

Read the operating, safety, and maintenance information as well as troubleshooting and parts and service information provided in the Hydronic Heating System Operation Manual in your InfoCase.

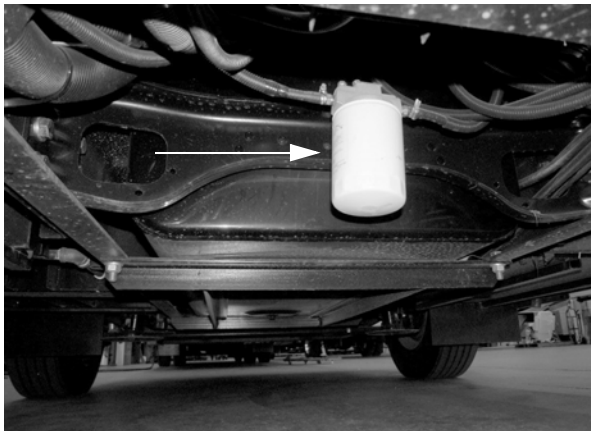

Aqua-Hot Fuel Filter
(Located in center of coach
behind front wheels)
-Typical View

FURNACE-A/C THERMOSTAT OPERATION CHART

The following chart shows the system functions with the “Heat/Cool” thermostat. Disregard references to heat functions when using the “Cool Only” thermostat in the rear bedroom.

X = Switch Position O = Switch position does not matter or is inactive for this feature

FAN MODE SWITCH		THERMOSTAT SWITCH				FAN SPEED SWITCH		WHAT HAPPENS
Auto	On	Cool	Off	Gas *	Elect *	Lo	Hi	
X			X			O	O	If the Thermostat Switch is Off and the Fan Switch is on Auto, the whole heating and cooling system is off - nothing is happening.
	X		X			X		A/C Fan runs continuously at Low Speed.
	X		X				X	A/C Fan runs continuously at High Speed.
Gas Furnace Heating:								
O	O			X		O	O	Furnace Blower runs along with the LP Gas Furnace, which turns on and off as needed according to thermostat setting.
Heat Pump Heating: *								
X					X	O	O	A/C Fan runs at Low Speed along with the Heat Pump, which turns on and off as needed according to thermostat setting.
	X				X	O	O	A/C Fan runs continuously at Low Speed while the Heat Pump turns on and off as needed according to thermostat setting.
A/C Cooling:								
X		X				X		A/C Fan runs at Low Speed along with the Air Conditioner, which turns on and off as needed according to thermostat setting.
X		X					X	A/C Fan runs at High Speed along with the Air Conditioner, which turns on and off as needed according to thermostat setting.
	X	X				X		A/C Fan runs continuously at Low Speed while the Air Conditioner turns on and off according to thermostat setting.
	X	X					X	A/C Fan runs continuously at High Speed while the Air Conditioner turns on and off according to thermostat setting.

* NOTE: These instructions include the optional heat pump, which may not be equipped on your model. If you do not have a heat pump, the Thermostat Switch Gas position is the same as the Heat position on your thermostat. In this case, ignore the Electric Heat Switch settings, which apply to the heat pump only.

HEAT PUMP

-If Equipped

Your coach may be equipped with an air source heat pump built into the air conditioning system. Because the heat pump operates on electricity, it provides economical heat inside your coach and helps reduce the use of propane gas for heating in cooler weather.

A heat pump can be thought of as an air conditioner running in reverse. An air conditioner absorbs heat from the air on the inside of the coach and moves it to the outside.

The heat pump does exactly the opposite. Even cold air contains some heat, so a heat pump will extract heat from the outside air on a cold day and carry it to the inside of the coach to maintain a comfortable temperature.

The efficiency of a heat pump decreases as the outdoor air temperature drops, so supplementary heat is often needed when the outside temperature nears freezing. This system is set to automatically start the gas furnace to assist the heat pump if room temperature cools to 5 degrees or more below the thermostat set temperature. You may wish to manually switch to furnace heat to maintain a higher temperature when outside

temperatures begin to reduce the efficiency of the heat pump. The heat pump will not operate when the outside temperature falls below 36 degrees F.

To operate the heat pump:

See the air conditioning/heat pump manufacturer's information in your InfoCase for complete operating instructions.

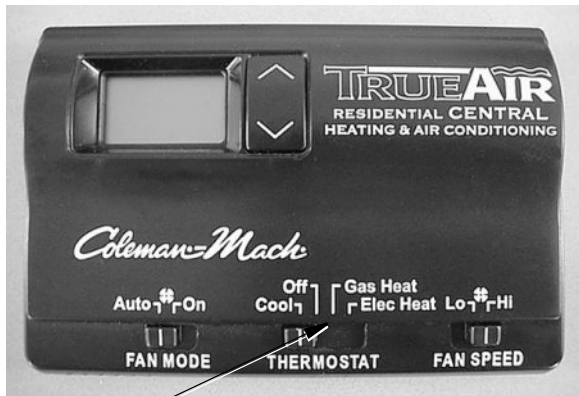

- Gas Heat = Gas Furnace
- Elec Heat = Heat Pump
- Cool = Air Conditioner

Check your Air Filter

Closed or blocked vents and a dirty air filter can hinder the efficiency of a heat pump.

- Be sure ceiling vents are open to distribute heat pump output air.
- The A/C return air filter should be checked monthly for dirt build-up and cleaned or replaced as needed. See “Air Conditioner Filter” elsewhere in this section.

CENTRAL AIR CONDITIONER

NOTE: See “Electronic Thermostat” for instructions on turning the air conditioner on and changing the temperature settings.

The central air conditioner is located behind the louvered body panel on the right (passenger) side of the coach. The panel can be opened for maintenance and periodic service. (See “Condenser Coils” elsewhere in this section.)

The cooled air is forced through ducts in the ceiling of the coach. Inside air returns to the air conditioner through a filter system in the rear bedroom area of the coach. (See “Air Conditioner Filter” elsewhere in this section.)

Condenser Coils

The condenser is located behind the louvered body panel on the right side of the coach. The condenser is the large, black, rectangular area that looks like a car radiator. The panel is hinged at the top edge to allow opening for periodic cleaning or service. Remove the screws under the lower edge of the panel and swing it upward for access to the condenser.

Periodically sweep debris carefully from the fins of the condenser. Rinse dust off with clean water. The condenser coils must be clean and free of dust, debris and insect particles, etc., for the air conditioner to cool efficiently.

Further Information

See the air conditioner manufacturer's operating instructions supplied in your InfoCase. They contain detailed operating instructions, special precautions and basic troubleshooting.

AIR CONDITIONER FILTER

The disposable furnace-type filter must be inspected monthly and replaced periodically so the air conditioner will operate efficiently.

The air filter is woven fiberglass, which cannot be cleaned and should be replaced when coated with dust.

Filter Location

Beneath Rear Lavatory Cabinet (behind removable access panel)

-Model 40CD

- Remove access panel underneath rear lavatory cabinet as shown in the following illustration to access filter.

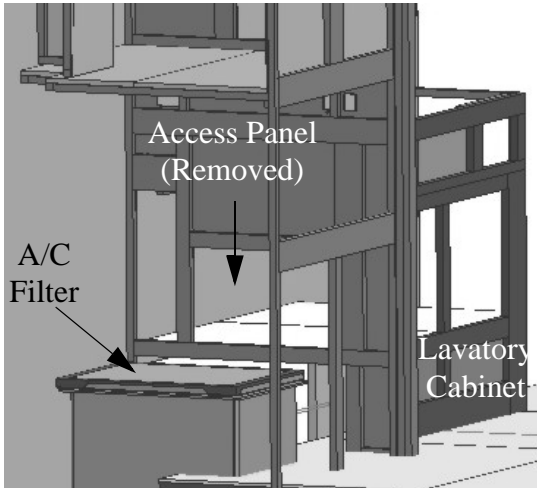

A/C Filter Access
***MODEL 40CD**
 (Located beneath rear lavatory cabinet)
 -Typical View
Filter Size: 14" x 20" x 1"

Beneath Floor Panel in Wardrobe -Models 40BD and 40WD

- Remove floor panel from wardrobe as shown in the following photo to access filter.



AC/Furnace Filter Access
***MODELS 40BD and 40WD**
 (Located under wardrobe floor panel)
 -Typical View
Filter Size: 14" x 20" x 1"

Filter must be installed with airflow markings (arrows) pointing downward.

NOTE: Do not block the filter in any way, such as by setting packages or newspapers, etc. in front of the return air grate. There must be free airflow for the air conditioner to operate efficiently.

Inside Return Air Vents -Model 42AD

Air conditioner filters are located inside the Return Air Vents throughout the ceiling of the coach and must be inspected monthly and cleaned periodically so the air conditioners will operate efficiently.

Supply airflow comes from the vents located on the driver side of the coach. Return Air Vents are located on the passenger side of the coach. It is the Return Air Vents in which the cleanable air filters are installed.

It is recommended to use mild soap and warm water to clean the air filters. When finished, allow air filters to air dry.

NOTE: There are multiple Supply and Return Vents throughout the coach. Therefore, you must remember to remove each separate air filter from each Return Air Vent to clean.

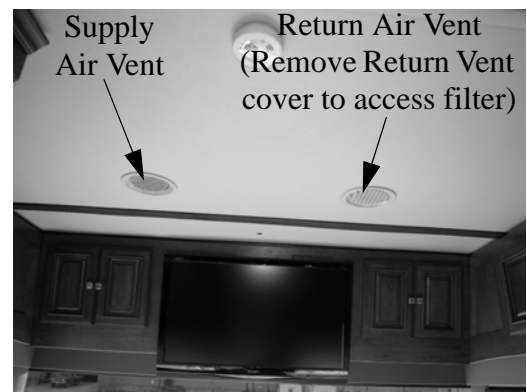

Supply/Return Air Vents
***MODEL 42AD**
 (Located throughout the ceiling of the coach)
 -Typical View

- Unlatch clips located on the sides of the Return Air Vents and remove.
- Remove air filter to clean.

**WASHER/DRYER
–If Equipped**



To Open the Door During a Wash Cycle

Follow these steps if you need to open the door to your washer/dryer after a cycle has already begun.

1. Advance the Program Selector to “Reset” and wait 5 seconds.
2. Advance the Program Selector to “Drain” (8 o'clock) and allow the machine to drain completely.
3. Advance the Program selector to “Reset” (the “Status/Door Lock” LED will blink quickly to indicate that the cycle has stopped, but the door is **STILL LOCKED**).
4. When the “Status/Door Lock” LED blinks **SLOWLY** (takes 1-2 minutes), you can open the door.

To Open During a Dry Cycle

1. Advance the Program selector to “Reset” (the “Status/Door Lock” LED will blink quickly to indicate that the cycle has stopped, but the door is **STILL LOCKED**).
2. When the “Status/Door Lock” LED blinks **SLOWLY** (takes 1-2 minutes), you can open the door.

IMPORTANT!** Once a wash cycle is underway, the washer/dryer door will **LOCK** for the duration of the cycle and will **STAY LOCKED

*for up to 2 minutes after the cycle ends. **DO NOT** attempt to open the door unless the “STATUS/DOOR LOCK” LED is **BLINKING SLOWLY!***

Water Supply Faucets

The washing machine water supply faucets are located inside the cabinet door above the machine. Always turn supply faucets off when not using washing machine to avoid possible water leaks if a hose or hose gasket should fail.



Water Supply Faucets - Typical View

See Winterization Procedure in Plumbing section.

Further Information

For complete washer/dryer operating instructions, see the manufacturer’s information provided in your InfoCase.

WASHER/DRYER - STACKABLE -If Equipped



To Reset or Cancel a Wash Cycle

If resetting or canceling a program is necessary:

1. Rotate the PROGRAMS dial clockwise to a STOP/RESET position.
2. Wait five seconds.
3. Rotate the PROGRAMS dial to the desired washing program, or DRAIN.

After the washer drains, wait for the DOOR LOCK light to extinguish before attempting to open the door.

The washing machine door will stay locked for up to two minutes after the program is completed.

NOTE: Never attempt to open the door when the DOOR LOCK light is on!

Water Supply Faucets

The washing machine water supply faucets are accessible below the lavatory cabinet (Model 40CD) or behind a removable access panel on the side of the washer/dryer cabinet (Model 42AD). Always turn water supply faucets off when not using washing machine to avoid possible water leaks if a hose or hose gasket should fail.

Model 40CD

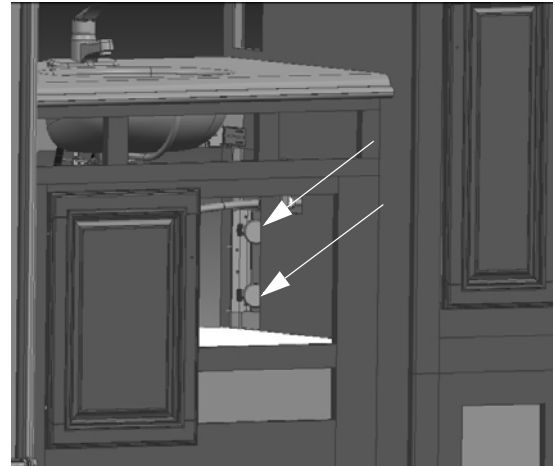

Water Supply Faucets
(Located below bathroom sink)

Model 42AD

NOTE: Bedroom slideout must be extended to get to the access panel.

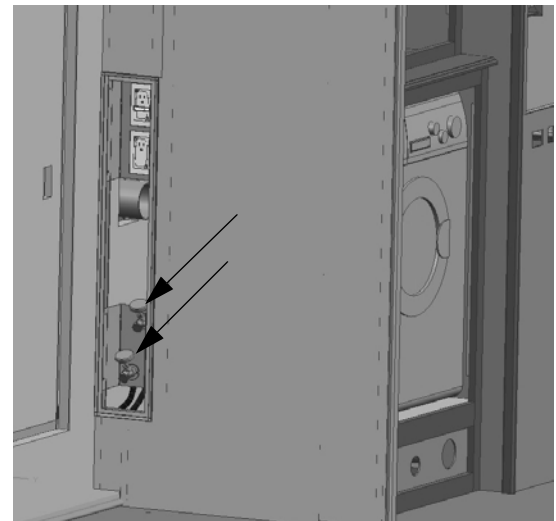

Water Supply Faucets
(Located on the side of washer/dryer cabinet - remove panel to access)
* Shown with slideout room extended

See Winterization Procedure in Plumbing Section.

Further Information

For complete washer/dryer operating instructions, see the manufacturer's information provided in your InfoCase.

**WASHER/DRYER - PREP
PACKAGE**

If your coach is not equipped with the washer/dryer option, plumbing may be present for installation of a washer/dryer.

Typically, the plumbing is located inside the rear linen cabinet (remove shelving and panels to access).

We recommend obtaining parts and service for the washer/dryer installation from your Winnebago® or Itasca® dealer.

**DISHWASHER
(Drawer Style)
–If Equipped**



Lock Feature

The Dish Drawer must be programmed to the “Closed Drawer” mode to keep the drawer locked while driving.

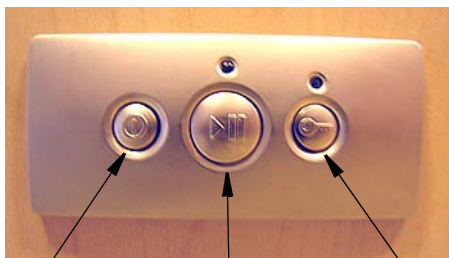

Power Button Start/Pause Button Lock Button

1. Press the Power button (left side of touch panel).

2. Open the drawer, then press the ECO button on the inside of the drawer and the Lock button (right side of touch panel) at the same time until you hear one long beep.
3. Press the Start/Pause button (center of touch panel) 3 times (the light above the button will be red).
4. Press the Lock button (right side of touch panel) to turn the “Closed Drawer” feature on. The lights on display panel inside of the drawer will light up.
5. Press the Power button (left on touch panel) the unit is set.

NOTE: If the power is disconnected and restored, the drawer will unlock then lock itself after 30 seconds. It will stay locked when power is disconnected and must have power connected to open.

To open the drawer in this mode, you must press the Start/Pause button.

Further Information

See the manufacturer’s Dish Drawer User Guide provided in your InfoCase.

**CENTRAL VACUUM CLEANER
–If Equipped**

The central vacuum cleaner system is located in a passenger side storage compartment.

The vacuum cleaner operates on 120-volt household current, so the shoreline must be connected to provide power.

To Use The Vacuum

Plug the hose into the hose outlet. The vacuum cleaner will start automatically. When you remove the hose, the vacuum will stop.



Central Vacuum Cleaner System

To Use Vac Pan

Press the vac pan lever to the right using your foot as shown to open the door and turn on the vacuum unit. Sweep floor debris into the opening. When you release the spring-loaded door it will automatically shut and turn off the vacuum unit.



Exterior Storage Compartment Vacuum

An additional vacuum hose outlet is located in a middle storage compartment on the passenger side of the coach for convenient cleaning of exterior storage compartments and other items outside of the coach.



To Change Filter Bags

Pull the cover from the square metal canister. The canister is located in an exterior storage compartment on the passenger side of the coach.

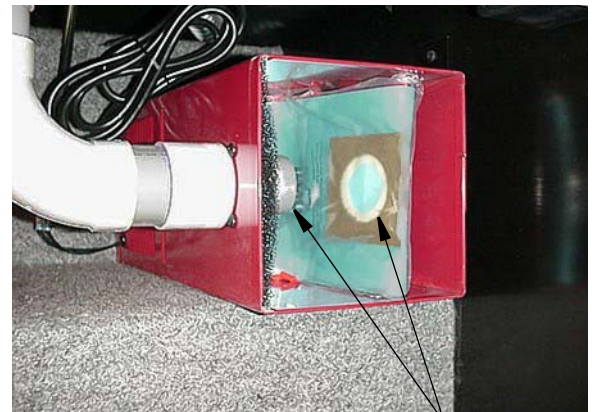

Dust bag inlet opening fits over side nozzle

If The Vacuum Will Not Start

Check for a tripped circuit breaker. Also be sure that the vacuum unit is plugged into the electrical outlet in the exterior storage compartment, and the shoreline is connected.

TOUR

SECTION 5 – PROPANE GAS

PROPANE GAS SUPPLY

The propane gas system supplies fuel for the gas range/oven, water heater, furnace, and refrigerator (while in gas mode). When used and handled properly, this system is safe and economical and provides modern living conveniences wherever you travel.

See *Section 2 - Safety and Precautions* in this manual for other safety and precautions you need to be aware of related to propane.

How Propane Gas Works

Propane is a type of LP (Liquefied Petroleum) gas compressed into liquid form for easy transportation and storage. Propane gas may also be called tank gas, bottle gas, or simply LP.

Propane is used by appliances in vapor form only, but is stored in the tank as a liquid under very high pressure. As the liquid gas is released, it reverts back to a vapor and expands to many times its compressed volume.

Propane Tank System

The storage reservoir for the propane gas system is a horizontally mounted tank which is permanently attached to the vehicle frame. The tank is accessible only from the outside of the vehicle.

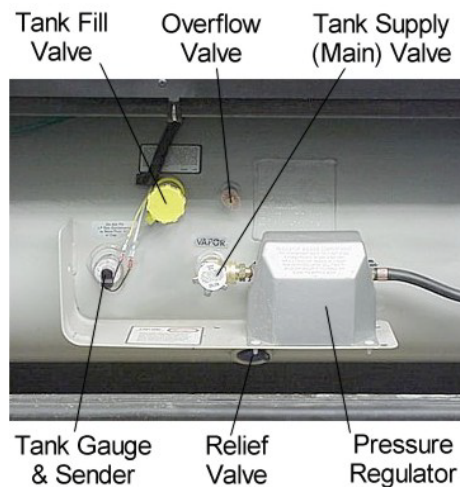

Propane Tank Features
-Typical View



WARNING

Do not alter or remove propane tank valves or gauge. Propane can escape, which can cause an explosion resulting in death or serious injury. Have the propane system serviced by a qualified service center.

Refilling Propane Tank

Since the propane tank is permanently mounted to the frame, the motor home must be taken to a propane dealership for filling. Do not attempt to remove the propane tank from the vehicle. The tank is equipped with a fill adapter with both internal and external threads, which allows easy filling with any propane filling equipment. The tank is full when liquid propane gas appears at the overflow valve.

NOTE: The propane tank is equipped with an automatic 80% stop-fill device.

 **DANGER**

DO NOT FILL CONTAINER TO MORE THAN 80 PERCENT OF CAPACITY. FAILURE TO COMPLY COULD RESULT IN A FIRE OR PERSONAL INJURY.

Make sure the motor home is level when filling. It is possible to accidentally overfill the tank if the vehicle is not level, with the fill valve on the uphill side. Overfilling the propane gas tank can result in uncontrolled gas flow, which can cause fire or explosion. A properly filled container will contain approximately 80 percent of its volume as liquid propane gas.

All pilot lights must be extinguished and appliances and their ignitors turned off, and supply valve closed before refilling propane gas tanks or vehicle fuel tanks.

Do not smoke or expose an open flame while near a propane refueling area. Propane gas is heavier-than-air and extremely flammable.

Never fill the propane tank with engine or generator running.

Before opening the supply valve, check to be sure all controls for gas appliances are in the “Off” or “Pilot Off” position. If this step is not performed, propane gas could accumulate inside the motor home creating a fire or explosion hazard.

Never use an open flame to test for propane gas leaks.

Replace all protective covers and caps on propane system before filling.

Selecting Propane Fuel Types

We recommend using straight propane in your propane tank. Propane gas is commonly available at all propane gas outlets in the U.S. (According to the National Propane Gas Association, propane gas outlets in the United States do not offer any other type of liquefied petroleum gas than propane to the general public.) Check local

phone directory yellow pages for locations of local propane gas refilling stations or bulk dealerships.

NOTE: If you travel outside the U.S. with your motor home, you may find butane or propane/butane mixtures available in addition to propane. Because gas-burning RV appliances are designed to run on propane only, we recommend that you request straight propane only. Butane burns about 30 percent hotter than propane and can overheat some appliances, particularly refrigerators, and cause permanent damage. Other appliances designed to operate on propane can become sooted and lose efficiency by using butane fuel.

Air in the Propane Gas Tank

If your gas appliances do not stay lit or require frequent adjustment, even though you know the propane tank contains sufficient fuel, the problem may be air in the propane gas tank. Air in the tank mixes with the propane gas vapors causing them to burn poorly. This condition could linger for weeks if the air is not purged from the tank. Most propane gas dealers have equipment for purging air from propane gas tanks and will purge before refilling the tank.

SAFE USE OF THE PROPANE GAS SYSTEM

The propane system is designed and built with strict adherence to national, state, and recreational vehicle industry requirements for mobile propane gas equipment.

For your safety, there are many safety devices and backup systems installed, such as tank fill overflow valves, an interior propane gas detector/ alarm, and an interior carbon monoxide (CO) detector/alarm.

Propane gas also contains an odor additive that you can smell if propane is present in the air.

Here are a few precautions to observe that will help you to use the propane gas system safely:

- Exercise caution at all times. Be familiar with the distinctive odor of propane gas. If a leak is suspected, turn off the supply valve immediately. Have the propane gas system checked by your dealer or other qualified propane gas service center.
- Do not tamper with the propane gas piping system, pressure regulator, or gas appliances. Service and maintenance of propane gas system components should be performed only by your dealer or a qualified propane gas service center.
- Never attempt to connect natural gas to the propane gas system.
- Have the entire propane gas system inspected for possible leaks and missing or damaged parts at each tank filling. Also inspect before and after each trip, and any time trouble is suspected.
- Turn the propane supply valve off when not using the propane gas system.
- Never use a wrench to tighten the tank supply valve. It is designed to close leak-tight by hand. If a wrench is required to completely close the valve, it is defective and must be replaced.
- Be sure appliance and outside vents are open and free from obstruction when using the propane gas system.
- Never attach a lock or any device requiring a key to the propane tank compartment door. According to standards set for recreation vehicles, the propane supply valve must be readily accessible in an emergency.
- Exercise caution when drilling holes or attaching objects to the walls. Gas lines and electrical wiring could be seriously damaged and present an extreme safety hazard.

PROPANE GAS WARNINGS AND PRECAUTIONS

It is illegal for vehicles equipped with propane tanks to travel on certain roadways or through certain tunnels in the U.S. To avoid inconvenience, check state regulations concerning flammable gas transportation.

Propane Gas Leaks

The following label is located in the vehicle near the range area. If you smell gas within the vehicle, quickly and carefully perform the procedures listed.

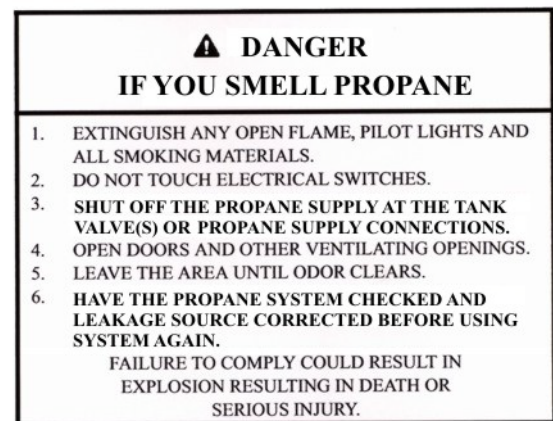

- All pilot lights must be extinguished and appliances and their ignitors turned off while refilling the fuel tank or propane tank.
- Never smoke while refilling vehicle fuel tank or propane gas tank.
- Avoid inhaling exhaust gases produced by burned gasoline, diesel fuel, or propane gas in items such as the range, chassis engine, generator engine, refrigerator, furnace, and water heater. They contain carbon monoxide, which is an odorless, colorless, and poisonous gas.

 WARNING

Propane cylinders shall not be placed or stored inside the vehicle. Propane cylinders are equipped with safety devices that relieve pressure by discharging propane to the atmosphere. Failure to comply could result in death or serious injury.

- Never use an open flame to test for propane gas leaks. Replace all protective covers and caps on propane system after filling. Make sure valve is closed and door latched securely.
- Portable fuel-burning equipment, including wood and charcoal grills and stoves, shall not be used inside the recreational vehicle. The use of this equipment inside the recreational vehicle may cause fires or asphyxiation.
- Regulators are equipped with a protective cover. Make sure that the regulator vent faces downward and that the cover is kept in place to minimize vent blockage, which could result in excessive gas pressure causing fire or explosion.

 WARNING

Visually inspect the pressure regulator vent periodically for blockage by accumulated debris or insect nests, etc. Vent obstruction could result in excessive pressure causing fire or explosion, which could result in death or serious injury. If an obstruction exists, have the regulator serviced by a qualified service center.

NOTE: If your model is equipped with a propane powered electrical generator, there will be two regulators stacked one upon another. One regulates the house propane supply pressure, the other regulates pressure to the generator.



PROPANE GAS PRESSURE REGULATOR

The pressure regulator is protected from the elements by a plastic cover, which should be left in place at all times.

Propane regulators must always be installed with the regulator vents facing downward. Regulators that are not in compartments have been equipped with a protective cover. Make sure that the regulator vent faces downward and that the cover is kept in place to minimize vent blockage that could result in excessive propane pressure causing fire or explosion.

Only your dealer or a qualified propane gas service should remove the regulator cover for adjustments.

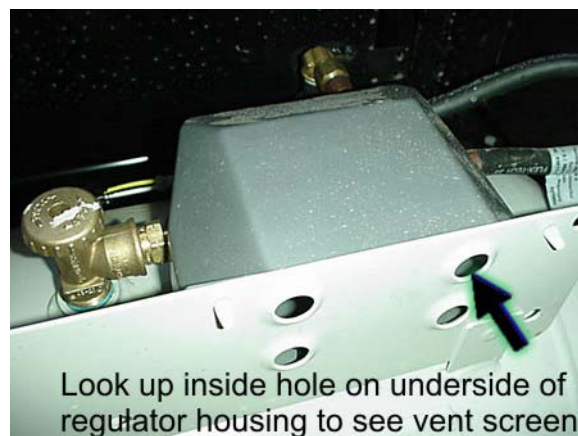

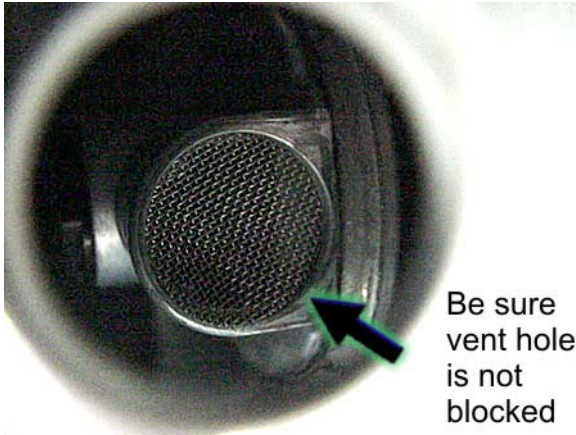

Regulator Freeze-up

Regulator freeze-ups are caused by the presence of moisture in fuel. This moisture will pass through the cylinder valve and into the regulator where it can freeze. Fuel producers, tank and bottle manufacturers, and propane gas dealers take every precaution to reduce moisture, but sometimes only a fraction of an ounce entering the tank can cause problems. To help avoid the possibility of freeze-up, always keep tank control valve closed when not in use, even when tank is empty, to prevent moisture from collecting on the inside.

If regulator freeze-up should occur, you may attempt to thaw the regulator using a light bulb. **DO NOT USE AN OPEN FLAME OR HEAT LAMP.**

If moisture begins to cause problems, have your propane gas dealer inject a small amount of dry methyl alcohol in your tank (approximately one ounce to 20 pounds or one pint to 100 gallons) to help guard against regulator freeze-ups.

PROPANE VAPORIZATION IN COLD WEATHER

Propane gas vaporization increases and decreases in direct relation to ambient temperature. In other words, the lower the temperature, the slower the liquid propane will vaporize into a usable gas for appliances.

This means that in extremely cold weather when a large volume of gas is being used by the furnace for heating, it is possible to experience a loss of gas pressure.

At first, this problem may appear to be caused by an empty tank or a regulator freeze-up, but is actually caused by failure of the liquid gas to vaporize as fast as it is needed by the furnace.

The demand for propane to produce heat increases to the point where the gas cannot vaporize fast enough to keep the furnace going. The only solution to this problem is to reduce gas usage where possible.

Adjusting the temperature on the gas/electric refrigerator may be a first step. Using less hot water will also help, as well as refraining from using the gas cooktop. A final step is to lower the thermostat setting to reduce gas usage by the furnace.

TOUR

SECTION 6 – ELECTRICAL

Your coach is equipped with an electrical system consisting of two separate voltages:

- 12-volt DC system (battery current); and
- 120-volt AC system (household current)

The 12-volt system consists of two internal power sources, while the 120-volt system is operated from an outside power source or the optional 120-volt generator.

ELECTRICAL CAUTIONS

- Careless handling of electrical components can be fatal. Never touch or use electrical components or appliances while feet are bare, while hands are wet, or while standing in water or on wet ground.
- Improper grounding of the vehicle can cause personal injury. Do not plug the utility power cord into an outlet which is not grounded and do not adapt the plug to connect to a receptacle for which it is not designed.
- Do not attach an extension cord to the utility power cord.
- Be sure that all electrical appliances to be used contain 3-prong plugs for proper grounding.
- Avoid overloading electrical circuits. Replace fuses or circuit breakers with those of the same size and amperage rating only. Never use a higher rated fuse or breaker.
- Use caution when handling or working near electrical storage batteries. Always remove jewelry and wear protective clothing and eye covering. Avoid creating sparks.

ELECTRICAL SYSTEM – HOUSE 120-VOLT AC

The 120-volt system operates from the shoreline cord connected to an outside 120-volt utility service, such as those at campgrounds or from the 120-volt generator. When the shoreline cord is connected to an outside power source, or when the auxiliary electric generator is running,

the power converter automatically changes a portion of the 120-volt current to 12-volt DC current. All equipment in the motor home that is normally powered by the house batteries is then powered through the converter.

In addition, the following equipment is entirely dependent on 120-volt current: air conditioner, refrigerator (when placed in AC mode), microwave oven, and any 120-volt electrical equipment used at convenience outlets.

EXTERNAL POWER CORD (Shoreline)

The external power cord (commonly referred to as a “shoreline”) is located in a the utility compartment on the left (drivers) side of the coach.



WARNING

Do not use an extension cord. Improper sized cords, damaged cords, and poor connections can lead to fire, which can result in death or serious injury.



WARNING

Do not connect the external power cord to any receptacle until you have verified proper polarity and grounding. Be sure that all three prongs of the supply cord are properly plugged into the receptacle. Failure to observe can result in death or serious injury.

The power cord is designed to ground the electrical system through the receptacle. It is also designed to carry the amperage output of most campground outlets. If the electrical receptacle to

be used is designed to mate with the prongs of the power cord plug, the electrical connection can be expected to carry rated load.

Connecting The Power Cord

To connect to an external source, remove the cord from the utility compartment and plug it into a suitable 50-amp power receptacle to provide external power to the coach and converter/charger system.

NOTE: Some parks do not have 50-amp service available, so you will need to connect to a standard 30-amp service pole using an adapter.

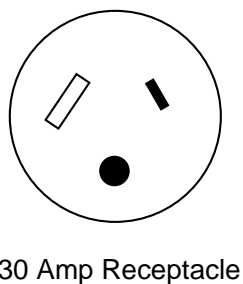
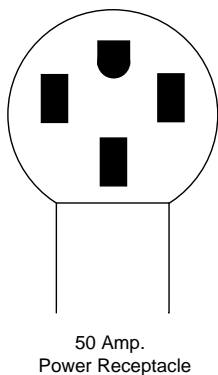

A flip-down hatch lets you route the power cord out the bottom of the compartment so you can close the compartment door while the power cord is connected.



1. Flip the hatch downward.



2. Swivel the cover section aside to reveal cord notch.



3. Route the cord through the notch and flip the hatch back up into place and close the compartment door.

NOTE: Always keep service access passage closed while utility connection is not in use.

Park Fuses or Breakers

Most campgrounds are equipped with a fuse or circuit breaker at the receptacle. This protects the park's wiring, as well as the power cord on your vehicle, from electrical damage. If electrical power fails, contact the park attendants and have them check the fuse or breaker for your supply receptacle.

After disconnecting the power cord, neatly stow it in the utility compartment.

POWER CORD REEL

–If Equipped

Your coach may be equipped with a 12-volt power cord reel to assist in the retraction of the external power cord (shoreline).



Power Cord Reel
(Located inside an exterior compartment)
-Typical View

To Extend the Power Cord

- Pull out power cord (manually) to a sufficient length and route power cord to an electrical receptacle and plug in.

To Retract the Power Cord

- Detach plug from receptacle using the lever on plug.
- PRESS and HOLD the Power Cord Reel Switch (located near the power cord reel) and the power cord will retract automatically.

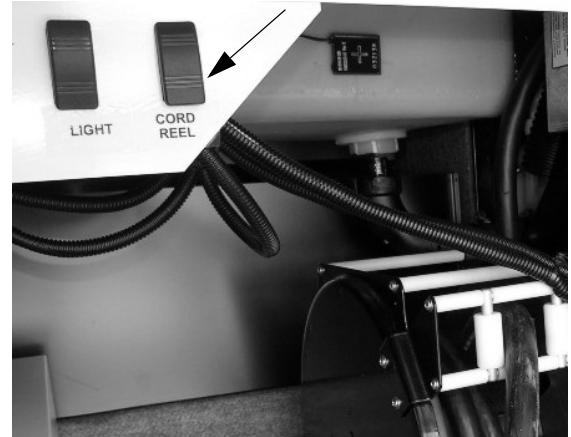

Power Cord Reel Switch
(Located near the power cord reel)
-Typical View

Further Information

See the manufacturer's user guide provided in your InfoCase for complete features, operating instructions, and precautions.

INVERTER/CHARGER UNIT – 2000W

–If Equipped

The inverter/charger unit is located on the wall of the utility compartment on the left side of the coach.

The inverter/charger has a power/reset switch and two circuit breakers to protect the inverter and the AC input source from overloads. See the inverter/charger operation information for complete explanation and instructions on this system.

NOTE: The inverter is not intended for steady use while “dry camping”. Batteries will deplete quickly with use of the inverter. The inverter is intended for limited, short term power usage when not connected to shoreline or generator power. The inverter can also be used while driving the motor home because the engine alternator will charge the batteries while driving.



Inverter Charger Unit
(Located in utility compartment)
-Typical Installation

NOTICE

Do not store items too closely around the inverter unit in the storage compartment. The inverter generates heat while operating and needs unrestricted airflow for proper cooling. Damage to the inverter can result.

The power converter changes 120-volt AC household current from the shoreline or generator into 12-volt DC current for use by 12-volt equipment in the motor home.

Charging Section

The charging section of the inverter/charger charges house batteries while 120-volt external power is connected.

If the house batteries have been extremely discharged, they will accept charge at a relatively high amperage rate. If they are only slightly discharged, they will charge at a lower amperage rate. The rate of charge will decrease as the batteries reach “full charge”, then will continue “trickle” charging at a very low amperage rate.

If your battery does not charge as described above, it is possible the battery is defective.

If the batteries are extremely discharged, the charger unit will not activate to charge batteries.

NOTE: We do not recommend leaving the shoreline plugged in continuously during storage periods because the batteries can lose electrolytic fluids and become damaged from continuous charging without periodic use. We recommend following regular battery inspection and maintenance, especially in cold weather. See “Battery Storage & Maintenance” at the end of this section.

Inverter/Charger Control Panel -If Equipped

The inverter/charger has a wall mounted monitor/control panel that can be programmed for several charging options. It will also display warnings for overload conditions or other operating failure conditions.

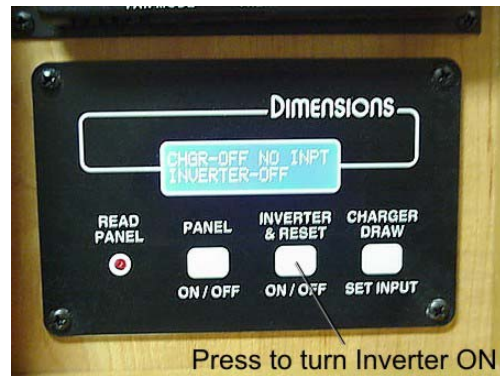

Inverter/Charger Control Panel

When the inverter is not being used, it should be shut off at the control panel. The inverter could drain the house batteries if the shoreline is not connected to external power and the Aux. Battery switch is on.

NOTE: Switch the refrigerator to GAS mode anytime you are running it with the shoreline unplugged to avoid discharging house batteries. The refrigerator draws its electrical current through the inverter and not directly from the shoreline. If the

refrigerator is in *ELECTRIC* or *AUTO* mode, it will continue to draw from house batteries through the inverter when the shoreline is unplugged unless the inverter is turned *OFF*.

Further Information

See the inverter/charger control panel instructions in your InfoCase for complete instructions and charging setup directions.

CIRCUIT BREAKERS – HOUSE 120-VOLT AC

The breaker panels protect all 120-volt components in the motor home from either an overload on the circuit or a short in the wiring or component itself. When an overload or short develops, the breaker will open preventing damage to the system.

Shut off the equipment (example: roof air conditioner) and allow a brief cooling period. Then reset the breaker by moving the switch to “Off” and back to “On”. If the breaker is continually tripped and no overload is evident, have the system checked for a short in the wiring or the appliances.

The breaker panels are located behind a door or pull-off panel on a lower cabinet face in the galley or lounge area or beneath the rear bed, depending on model.

NOTE: 40WD models only - the breaker panels are located behind the hinged mirror in the bedroom. Use the notch at the bottom edge of the mirror to pull out.

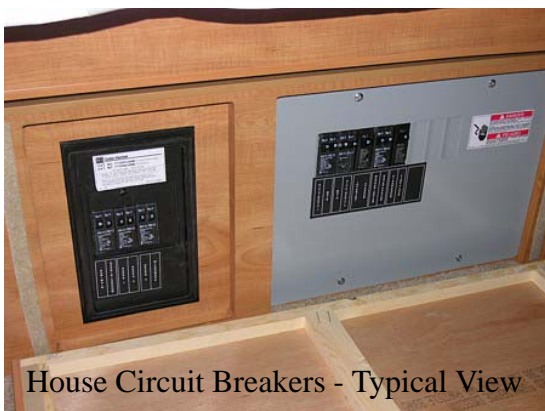

House Circuit Breakers - Typical View

**Breakers are labeled on panel. Arrangement may vary according to appliance and equipment options.*

ELECTRICAL OUTLETS – HOUSE 120-VOLT AC

A number of standard household electrical outlets are provided throughout the coach for connecting small appliances such as televisions, radios, toasters, etc.

An exterior outlet is also located on the outside of the coach near the entrance door or in a storage compartment on the passenger side of the coach.

GROUND FAULT CIRCUIT INTERRUPTER

Bath, galley, and exterior outlets are connected to a GFCI (Ground Fault Circuit Interrupter), which is an extremely sensitive circuit breaker that will help to protect against severe electrical shock if a ground fault develops. If such a condition occurs, the GFCI will break the circuit by turning off the power to the protected outlets. Should this occur, unplug all the appliances on that circuit and press the reset button on the GFCI equipped outlet.

If the GFCI keeps tripping, have the electrical system checked and repaired, if necessary, before using again.



Push to Reset circuit after monthly testing or ground fault tripping.

Push to Test at least monthly. Should break circuit. Press Reset button to reconnect.

GFCI Outlet
(Ground Fault Protector)

! WARNING

Do not plug the power cord into the generator receptacle while the generator is running. Electrical shock can cause personal injury.

**Automatic Power Transfer Switch
-If Equipped**

Whenever the generator is started, an automatic power transfer system automatically switches the household electrical system to the generator approximately 10 seconds after the generator is started. The 10 second delay allows the generator to start easily without the burden of electrical loads.

! WARNING

The GFCI will not completely eliminate the risk of electrical shock. Infants and small children may still be affected.



Automatic Power Transfer Box
(Located inside or behind utility compartment)
-Typical Installation

**ELECTRICAL GENERATOR
-If Equipped**

! WARNING

Careless handling of the generator and electrical components can be fatal. Never touch electrical leads or appliances when your hands are wet, or when standing in water or on wet ground. Do not attempt to repair the generator yourself. Service should be performed by a qualified service center.

**Automatic Generator Start (AGS)
-If Equipped**

The automatic generator start feature monitors house battery voltage and coach interior temperature, and has the ability to automatically start the generator to help maintain full air conditioning function and house battery charge.



The following label is located near the 120-volt house circuit breaker panel and at the generator to warn you to disconnect specific electrical connections before servicing the generator and storing the coach.

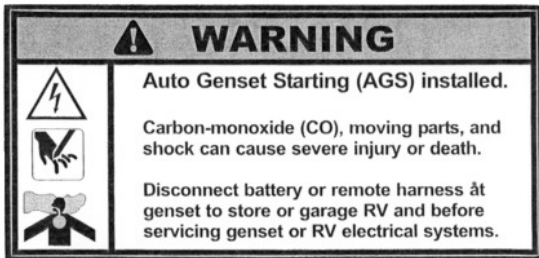

See the AGS user guide for more information to help understand the AGS feature and its operation with your generator.

Generator Basic Operation

To Start the Generator

Press and hold the generator switch in START position until you hear the generator running smoothly, then release.

To Stop the Generator

Press and hold the generator switch in STOP position until you hear the generator come to a full stop, then release.

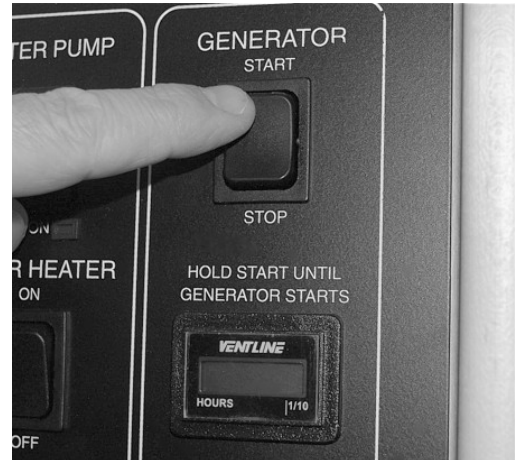

Generator Switch and Hourmeter
(Located on monitor panel)
-Typical View

Generator Hourmeter

The generator hourmeter is located on the monitor panel. It registers the total number of hours that the generator has been operated.

Refer to the hourmeter to determine when periodic maintenance is due and to record services which have been performed.

Operation Warnings and Cautions

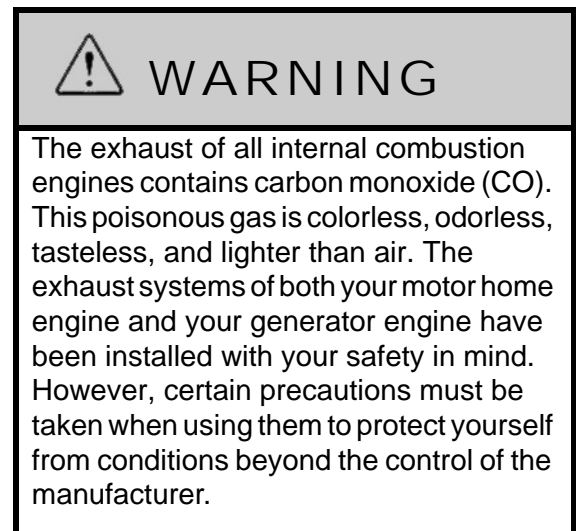

- Do not simultaneously operate the generator and a power vent, which could draw exhaust gases into the vehicle.

- Do not open windows or vents on the end or side of the vehicle where exhaust pipe of the generator is located.
- Park the vehicle so that the wind will carry the exhaust away from the vehicle. Also, note the position of other vehicles to be sure their exhaust will not enter your vehicle.
- Do not operate the generator engine while parked if vegetation, snow, buildings, vehicles, or any other object can deflect the exhaust under or into the vehicle.

Check auxiliary generator oil level frequently during periods of use. Refer to the generator manufacturer's user guide provided in your InfoCase for specific recommendations.

Replacing the Generator Air Filter (42AD models only)

NOTE: It is recommended that the engine air filter be changed every 500 hours of running time. Replace it more often in dusty environments.

Accessing the Air Filter

1. Open the front hood.
2. Remove all fasteners on the front and rear top access panels (except for the last two fasteners on the rear panel) with a 10 and 13 mm socket.

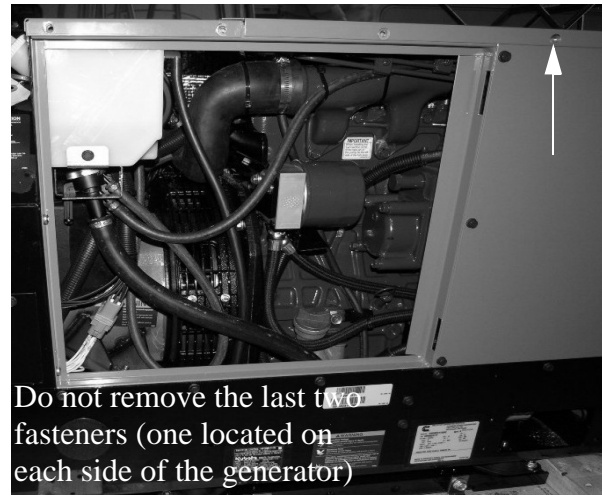
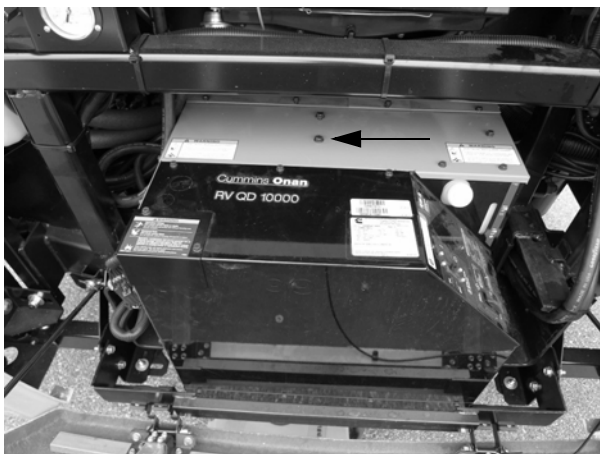

3. Remove side access panel (located on the right side of the generator) by releasing the latch (as shown in the following photo).

NOTE: Once the latch has been released, you must close the latch again to allow the side access panel to be removed completely.



4. Lift up rear access panel (to allow for clearance), then lift front access panel while pushing back gently and remove.

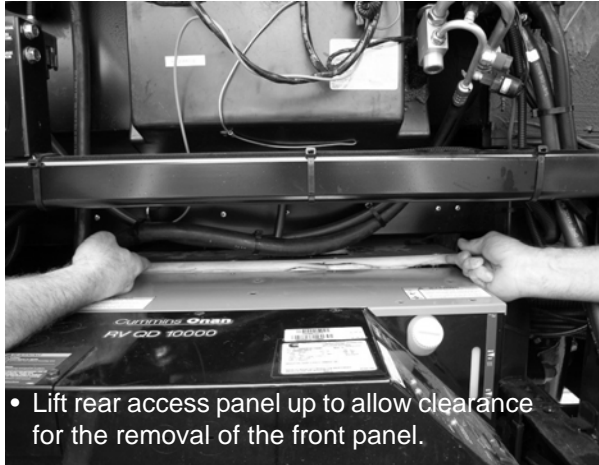

- Lift rear access panel up to allow clearance for the removal of the front panel.



- Lift front access panel, while pushing back gently and remove.

5. Remove front access panel.

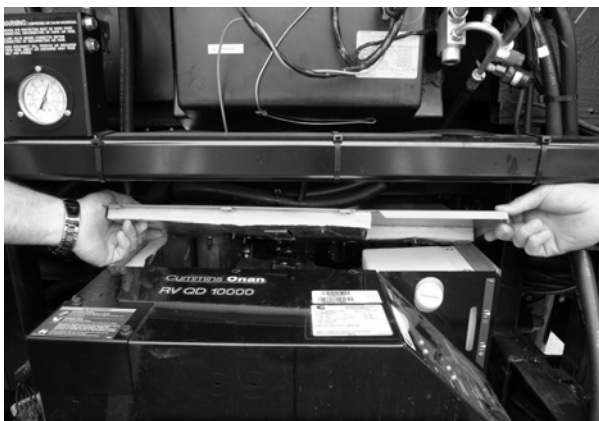

6. Release the spring clip on the air filter housing end cap to remove air filter.



7. Replace the air filter.



8. Secure the air filter housing end cap.
9. Reverse steps to reassemble generator access panels.

Checking Engine Oil Level (42AD models only)

NOTE: It is recommended that the engine oil level be checked daily to ensure top performance and long genset life.

Accessing the Engine Oil Dipstick

1. Remove side access panel (located on the right side of the generator) by releasing the latch (as shown in the following photo).

NOTE: Once the latch has been released, you must close the latch again to allow the side access panel to be removed completely.



Engine Oil Dipstick
(Located behind the side access panel)

NOTE: See the generator manufacturer's user guide provided in your InfoCase for further information on checking the engine oil level.

2. Once you have checked the engine oil level, reinstall the side access panel.

Further Information

Refer to the generator manufacturer's user guide provided in your InfoCase for specific recommendations, operating instructions and cautions, troubleshooting, and maintenance.

ELECTRICAL SYSTEM – HOUSE 12-VOLT DC

The DC voltage system consists of the chassis battery, the 12-volt house batteries, and the 12-volt power converter.

Converter

See "Power Center."

Chassis Battery

The chassis battery is used to operate the engine starter and automotive accessories and controls found on the instrument panel. The slideout room systems and the electric step are also connected to the chassis battery.

See your chassis manual for further information on chassis batteries and chassis electrical system.

House Batteries

House batteries are "deep-cycle" type batteries specially designed for recreational vehicle use. They will provide longer lasting power than standard automotive starting batteries and will withstand the frequent drain-and-recharge cycles that occur under the demanding conditions of a camping outing.

The house batteries supply power to 12-volt equipment located in the living area of the motor home. This includes the following 12-volt powered components (if equipped): interior 12-volt lighting, range exhaust fan, propane furnace fan, fresh water pump, systems monitor panel with water level and holding tank gauges, refrigerator, roof vent fans, and 120-volt electrical generator starter.

The house batteries can also provide emergency power to start the engine if the chassis battery is discharged. (See "Battery Boost Switch" or "Aux Start Switch").

House batteries are automatically charged by the chassis alternator while the engine is running.

BATTERY INFORMATION

Chassis Batteries

The chassis batteries operate the engine starter and all automotive accessories and controls found on the instrument panel. The leveling jacks, slideout room system and the electric step are also connected to the chassis battery.

A battery monitor device called Trik-L-Start™ will help maintain the chassis battery charge anytime the coach is plugged into 120-volt shore power and the battery disconnect switch is in the “On” position.

The device monitors battery voltage in the house batteries and compares it to the chassis battery. If the device senses the chassis battery voltage is approximately ½ volt lower than the house battery, it allows up to 5 amps of current to flow to the chassis battery.

The circuitry within the device prevents back feeding of electricity from the chassis to coach battery so if 120-volt power is interrupted, the chassis battery will not be discharged.

House Batteries

The house batteries supply current to 12-volt equipment located in the living area of the coach. This includes interior lights, range exhaust fan, furnace fan, water pump, water level and holding tank gauges, 120-volt generator starter, refrigerator and bath roof vent fan. The house battery may also be used to start the engine if the automotive battery is discharged. (See “Aux. Start Switch.” or “Battery Boost Switch” in Section 3.)

The house batteries are automatically charged by the chassis alternator while the engine is running.

HOUSE BATTERY DISCONNECT SWITCH

The House/Coach Battery Disconnect switch disconnects the house batteries from the 12-volt system of your coach during storage periods to

avoid battery drain by electrical items that are hooked directly to the house batteries, such as clock displays and radio memories, etc.

Always leave this switch ON while using the coach.



House/Coach Battery Disconnect Switch
(Located near entrance door)
-Typical View

NOTE: Some electronic displays and memory functions may need to be reset after power has been reconnected.

See also “Battery Care” elsewhere in this section.

BATTERY ACCESS

The batteries are located on slideout trays in the battery compartment on the outside of the coach.

Lift the retainer catches that hold the battery tray and slide it outward for service.



House Batteries

Chassis Batteries



Lift Battery Tray Retainer Latches

NOTICE

Always refasten battery retainers when returning a battery to the compartment.

BATTERY CARE

Lead-acid type batteries are electro-chemical devices for storing and releasing electrical charge. As such, they are simply an electrical reservoir, not an electrical source. As soon as energy is removed from the battery, it should be replaced by the engine alternator or the RV converter system.

If a battery sits unused for 30 days or more, especially during warm weather, it can develop a deposit of sulfate crystals on the metal plates inside the battery. This condition is called “sulfating” and prevents the battery from either releasing or accepting a charge. If this condition occurs, the battery must be replaced.

If a battery does not contain at least 80% charge during freezing temperatures, the electrolyte can freeze and crack the battery case.

The two best defenses against sulfating and insufficient charge are to:

1. Turn off the House/Coach Battery Disconnect (House/Coach Batt) switch to avoid parasitic discharge (the trickle discharge caused by directly connected components like propane gas detectors or digital clock displays, etc.)

2. Check the battery and recharge as necessary at least once a month during long storage periods. Turn the House/Coach Batt Switch off to avoid electrical arcing when attaching or detaching charger clamps.



WARNING

California Proposition 65 Warning:

Battery posts, terminals, and related accessories contain lead and lead compounds, chemicals known to the state of California to cause cancer and reproductive harm. Wash hands after handling.

NOTE: We do not recommend leaving the shoreline plugged in continuously during storage periods because the batteries can lose electrolytic fluids and become damaged from continuous charging without periodic use or maintenance. We recommend following regular battery inspection and maintenance, especially in cold weather.

Further precautions are:

- Remove the battery from the coach.
- Store it in a cool place.
- Check the state of charge periodically to avoid discharge or sulfating.

To ensure that the battery will always accept and hold a charge, follow these simple maintenance practices:

- Make sure the batteries always remain securely clamped in the battery tray.
- Make sure battery cable clamps are tight on the terminal posts and are free of corrosion.
- Neutralize corrosion buildup or acid film on top of battery by washing with a baking soda/water solution. Rinse with clear water.

NOTE: Make sure vent caps are on securely to prevent baking soda solution from entering the battery and contaminating the electrolyte fluid.

⚠ WARNING

Before removing any battery cables or battery, make sure all 12-volt equipment in the motor home is off and the power cord has been disconnected. Be sure to replace the battery terminal boot, if supplied, back onto the positive terminal after servicing. Care must be taken to avoid pinching the cable between any metal parts. Should the cable be damaged, a short circuit could result in personal injury or damage to equipment. Replace any damaged cables at once. Always remove jewelry and wear protective clothing and eye covering when checking or handling batteries.

- Clean and tighten battery terminals and have the specific gravity checked at least once a year.
- Check the battery fluid level every month, or more often in hot weather. Fill to approximately 3/8 inch above the plates. **DO NOT OVERFILL.** If fluid is added during freezing weather, the motor home should be driven several miles to mix water and electrolyte to prevent freezing.
- Fluid level check may be omitted if equipped with maintenance-free batteries.

⚠ WARNING

To prevent wiring damage, it is essential when replacing the cables on the battery, or when using a “booster” battery, that the positive post and the positive cable be attached and the negative post and negative cable be attached. The posts are marked (+) plus and (-) minus. If a “boost charger” is used while battery is in the motor home, disconnect both battery cables before connecting the charger to avoid damage to engine electronic components. Never attempt to charge or boost a frozen battery. An explosion can occur resulting in personal injury.

CIRCUIT BREAKERS – HOUSE 12-VOLT

All 12-volt circuits and equipment in the coach area of the motor home are protected by the breaker panel. When a circuit is overloaded or a short develops in any part of the system, a fuse or breaker will shut down that circuit. If this happens, turn off all affected lights or appliances and press the breaker in to reset.

The House 12-Volt Breaker Panel is located behind a lower cabinet door in the galley area or beneath the bed.

A label on the panel states the amperage rating and circuit protected for each breaker.

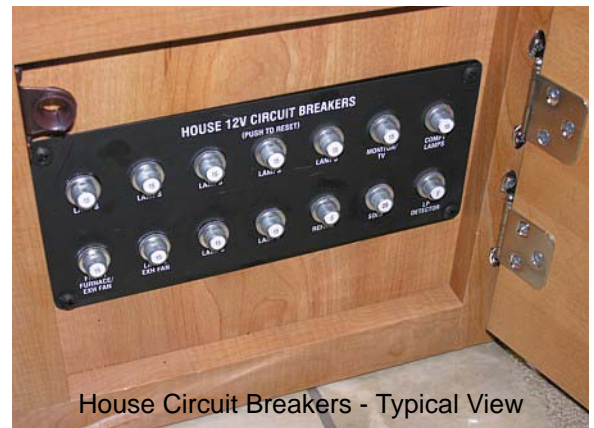

House Circuit Breakers - Typical View

**Typical view of breaker panel. Actual breaker panel location may vary according to model floorplan. Breakers are labeled on panel according to appliance and equipment options.*

TOUR

SECTION 7 – PLUMBING

FRESH WATER SYSTEM

The fresh water system provides water to the galley sink, shower, bathroom lavatory, toilet and water heater. Water may be supplied by either of two sources:

- a fresh water tank located within the motor home
- any external water source to which the motor home may be connected, known as “city water”.



Water Service Center - Typical View

Filling the Fresh Water Tank

Always fill the fresh water tank at an approved potable water filling facility or a known purified drinking water source.

The tank is filled through the city water connection (Fresh Water Inlet) or optional hose reel in the water center.

The Fresh Water Valve routes the water from the city water hose to the fresh water tank for filling.

1. Attach a hose from a city water faucet to the city water connector (Fresh Water Inlet) in the water center on the driver side of your coach (or pull a sufficient amount of hose from the optional water center hose reel – if equipped) and attach to an external city water faucet.



Water Hose Reel
(if equipped)
-Typical View

2. Turn the Fresh Water Valve to “Tank Fill” position.



Fresh Water Valve in Tank Fill position
(located in Water Service Center)

3. Turn city water supply on.
4. Tank is full when water flows from tank vent tube beneath coach.
5. Turn off city water supply and disconnect from city water connector.
6. Turn Fresh Water valve to Normal position to use the water demand pump. *The Tank Fill position is only for pressure filling the water tank from the city water hose connection.*



Fresh Water Valve in Normal use position
(located in Water Service Center)

Using City Water

When connected to an outside source of water, the water bypasses the demand pump and storage tank and supplies pressure directly to individual faucets and toilet. A check valve built into the pump prevents water from entering the pump and filling the storage tank.

1. Connect hose to city water connection as described in previous steps.
2. Turn Fresh Water Valve to Normal position and turn the water pump switches OFF.



Fresh Water Valve in Normal use position
(located in Water Service Center)

NOTE: Always keep the tank fill valve in Normal position unless you are filling the tank. If this valve is left in the Tank Fill position while using the city water, water will keep flowing into the tank and out the tank vent tube onto the ground and the water pump will run without delivering water to faucets.

Disconnecting from City Water

1. Turn the city water source off.

2. Open a faucet on the coach (such as exterior wash station) to relieve water line pressure.
3. Disconnect the hose from the city water faucet and store hose (retract the hose into the hose reel- if equipped). Be sure to replace the protective cap on the hose end to avoid entrance by debris or insects.



Press button and hold to retract water hose reel
(if equipped)

NOTE: Be sure the Fresh Water Valve is in Normal position to use the water pump. If the valve is in Tank Fill position, the pump will run continuously without delivering water.

Pressure Regulators

Because city water pressure varies from location to location, we recommend obtaining an in-line water pressure regulator to prevent damage to any components, connections and seals in your fresh water system. We recommend a regulator that controls water pressure to **50 psi. max.**

These devices simply connect in-line between the supply hose and the city water input on the coach.

Water pressure regulators are commonly available at most RV dealerships and many large retail discount or home supply centers.

WATER PUMP

When your coach is not connected to a city water supply, water is supplied from the fresh water tank by a water system demand pump. A demand pump is designed to run only when you

are using water. When you open a faucet, the waterline pressure drops and the pump begins to run, and it will continue to run as long as the faucet is open. When you close the faucet, the line pressure backs up to the pump, and it shuts itself off.

The pump is self-priming and will run briefly to build up line pressure when the Water Pump Switch is first turned on. See “Initial Waterline Priming” for instructions on using the water system for the first time.

Further Information

See the water pump manufacturer’s operation, care, and maintenance information in your InfoCase.

Pump Strainer

The pump is equipped with a cleanable strainer to capture any possible tank-borne particles that could damage pump components.

NOTE: We recommend that you check and clean the strainer after each tankful of water during the first few uses of the water pump system. Thereafter, remember to check it at least yearly, and be sure to empty water from it during winterization procedures.



Water Pump Strainer
-Typical View

To Clean Pump Strainer

- Be sure all water pump switches are OFF.
- Twist the inlet cap (bowl) counter-clockwise to unscrew from the strainer assembly.

- Remove the bowl and pull the strainer screen out of the bowl to tap out any particles and rinse clean.
- Insert the strainer screen back into the bowl, then screw the bowl back onto the strainer assembly.

NOTE: You must also empty the strainer when winterizing your coach to avoid water freezing and cracking the filter bowl.

Water Pump Switch

The water pump switch is located on the systems monitor panel. (Some models may have an additional switch in the water service center or within the bathroom area for your convenience).

While the switch is “ON”, the pump will automatically supply water as it is needed.

We recommend that you turn the water pump switch off whenever you will be away from the vehicle or not using the water system. In time, a slow leak in a faucet could drain the water tank, fill the holding tank, and discharge the house batteries.

Initial Waterline Priming

1. Make sure that all water drain valves are closed, including water heater valve.
2. Turn water pump switch to “OFF” position.
3. Fill water tank.
4. Open all faucets, hot and cold.
5. Turn on pump switch.
6. Close each faucet as it begins to deliver a steady stream of water (close cold water first). Leave hot water faucets on until they also deliver a steady stream of water. This will ensure that the water heater is filled with water.
7. Check to be sure pump stops soon after all faucets have been closed.
8. Pump is now ready for automatic operation. Pump will start when a faucet is opened and stop when the faucet is closed.

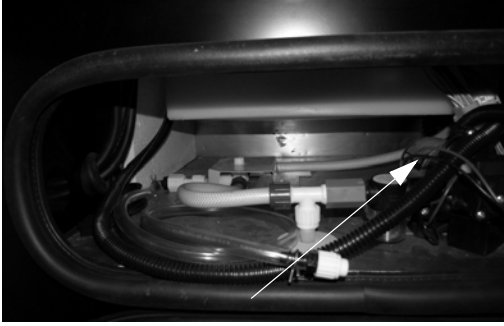

Water Pump
(Located in passenger compartment
near front of coach)
-Typical View



Water Pump Switch
(Located in bath area)
-Typical View



Water Pump Switch
(Located on the monitor panel)
-Typical View

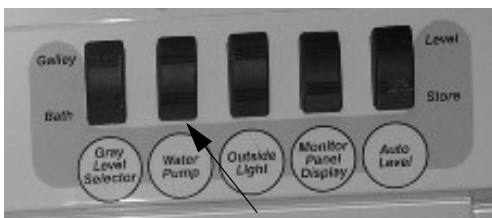

Water Pump Switch
(Located in water service center)
-Typical View

FILTERED WATER FAUCET -If Equipped

The filtered water faucet is connected to a flow-through, activated carbon filter cartridge that removes chlorine and odors for taste-free drinking water.



Filtered Water Faucet



Water Filter Assembly
(Located below Galley Sink)

Replacing the Water Filter Cartridge

Replace the filter cartridge when water flow from the faucet is too slow for convenience.

- Twist the filter cartridge counterclockwise (to the left) about one-quarter turn, then pull it down and out of the filter socket. *(A spring-loaded valve inside the filter socket will block water from flowing out of the socket when the filter cartridge is removed.)*
- Insert a new filter cartridge up into the filter socket as far as possible and twist it clockwise (to the right) one-quarter turn until it stops.



- Purge a new filter cartridge before using for drinking. Run a few gallons of water through the filter and discard the water (or use for watering plants) to avoid ingesting carbon dust or particles that may have been present in the new filter cartridge.

- See Winterization Procedure at the end of this section. Also see filter manufacturer's information in your InfoCase for further instructions or precautions.
- When removing the coach from storage, always disinfect and flush the water system thoroughly before installing a new filter.

FULL-COACH WATER FILTRATION SYSTEM

–If Equipped

The full-coach water filtration system is connected to the cold water lines throughout the coach. It uses a flow-through filter that removes chlorine, cloudiness and sediments, resulting in clear, odorless and taste-free clean water for drinking, cooking, and personal care.



Full-Coach Water Filter System
(Located in water service center)
-Typical View

Replacing the Full-Coach Water Filtration Cartridge

Replace the filter cartridge after 1,000 gallons of usage or sooner if water flow from faucets is noticeably reduced.

- Turn off the water supply and relieve water line pressure by opening a faucet.
- Remove the filter canister from the filter head. Use the filter wrench supplied to loosen the filter canister. (see following photos)



- Unscrew the canister from the filter head. (There will be water inside the canister.)
- Remove the large O-ring seal from the canister. Check seal for damage, wipe clean and set aside. Discard the used filter cartridge.
- Wash the inside of the canister with dish soap and warm water using a nonabrasive sponge or cloth. Rinse thoroughly.
- Fill canister about 1/3 with clean water and add a couple of tablespoons of household bleach, then scrub with a sponge or brush to disinfect. Rinse thoroughly.
- Lubricate the O-ring with clean silicone grease to ensure a proper watertight seal, then place back into the groove at the bottom of the canister threads.
The O-ring should be replaced every third cartridge change to insure proper sealing. (See your dealer for replacement cartridges and O-rings.)
- Insert a new filter cartridge into the canister, then hand tighten the canister securely onto the filter head. **DO NOT OVER-TIGHTEN.**

- Turn the Fresh Water Valve to Normal position, next open a faucet inside the coach or the exterior shower, then turn city water on **SLOWLY** to allow the canister to fill with water.
- Thoroughly flush the filtration system by running the water for twenty (20) minutes.
- Check for leaks. Done.

See “Winterizing Procedure” in this section to prepare the water filtration system for freezing conditions.

DISINFECTING YOUR FRESH WATER SYSTEM

To assure complete disinfection of the potable water system, it is recommended that the following procedure be followed on a new system, one that has not been used for a period of time, or one that could have become contaminated.

This procedure is also recommended before long periods of storage such as over winter.

Coaches with Full-Coach Water Filtration System (in Water Center)

1. Open a faucet to relieve any waterline pressure, then remove the filter canister from the filter base.
2. Remove the filter cartridge from the canister. Seal it in a clean plastic bag and set aside for reinstallation after disinfection procedure.
3. Pour 1 1/2 cups of household chlorine bleach (sodium hypochlorite solution) into the empty filter canister and screw the canister back onto the filter base.



WARNING

Chlorine is poisonous. Do not misuse. Recap bottle and clean all utensils after use.

This solution will result in a residual chlorine

concentration of approximately 50 ppm in the water system. *(If a 100 ppm concentration is desired as discussed in step 6, use 3 cups of household bleach).*

4. Connect a hose from a city water source to the City Water inlet and fill the fresh water tank completely. The bleach will be drawn into the tank when the city water is turned on and the tank fill valve is turned to Tank Fill position.
5. Open each faucet in the coach and run the water until a distinct odor of chlorine can be detected in the water discharged. Do not forget the hot water faucets.
6. Let the system stand at least 4 hours when disinfecting with 50 ppm residual chlorine. *If a shorter time period is desired, then a 100 ppm chlorine concentration (double the amount of bleach) should be allowed to stand in the system for at least 1 hour.*
7. Drain the fresh water tank.
8. Reinstall the filter cartridge into the filter canister, then refill the tank with fresh water.
9. Open each faucet again and run fresh water to flush chlorinated water from the lines. Run the water until there is no odor of chlorine detected in the water discharged. Do not forget the hot water faucets. *(You may need to leave a hot water faucet open for some time to flush the water heater with clean water. You may also want to turn the water heater off until this is done to avoid wasting energy trying to heat “unused” water).*
10. Water system is now disinfected.

City Water Hose Disinfection

NOTE: This procedure can be used periodically to sanitize the city water hose, and can be used as an alternate method of adding bleach solution to the fresh water tank if desired.

1. Connect your city water hose to the fresh water inlet of your coach.

2. Remove the full-coach filter cartridge from the filter canister to avoid prematurely “plugging up” the filter cartridge. Refit empty canister to filter head for procedure.
3. Hold the “city end” of the water hose upright and use a funnel to pour 1 1/2 cups of household chlorine bleach (sodium hypochlorite solution) into the hose. Keep the end of the hose held upright to avoid draining the bleach solution.
4. Connect the hose to a city water hydrant and turn on slowly, allowing the water to force the bleach through the hose, then continue filling the tank with water. (This will disinfect the city water hose at the same time.)
5. Let the system stand at least 4 hours when disinfecting with 50 ppm residual chlorine. *If a shorter time period is desired, then a 100 ppm chlorine concentration (double the amount of bleach) should be allowed to stand in the system for at least 1 hour.*
6. Drain the chlorinated water from the fresh water tank and refill with clean water.

Continuous Tank Disinfection (Superchlorination)

Some RVers like to ensure continuous sanitation of their fresh water tank by “superchlorination”—maintaining an effective low level of chlorine in the tank at all times.

- Add 1 teaspoon of chlorine bleach (sodium hypochlorite) to your tank for each 10 gallons of tank capacity. When you fill the tank, this will result in a 6.7 ppm level of chlorine, which should kill harmful bacteria and slime-forming organisms.
- Chlorine will be removed from drinking water by the full-coach filter and cold water filter at the galley.
- Superchlorination does not affect city water usage, only the fresh water tank.

SHOWER HOSE VACUUM BREAKER

After using the shower, you may notice water dripping from the shower faucet assembly. The dripping results when vacuum in the shower hose (after closing the shower faucet) slowly releases and allows water remaining in the hose to drain down. This is a normal function of the shower valve assembly and is not a leak or defect.

If items are placed into the shower tub before shower valve vacuum release is complete, they may become wet.

EXTERIOR SHOWER/WASH STATION

-If Equipped

The exterior wash station feature allows you to do things such as rinse off sand or salt after a swim, rinse off muddy boots, or bathe your pet outside the coach. Some models may have a water pump switch located near the shower faucet for convenience.



Exterior Shower/Wash Station
-Typical View

TOILET

The toilet in your motor home is very similar to the household type, except that it is designed to use only a small amount of water per flush. It uses a high velocity jet of water, producing a swirl effect, to efficiently cleanse the bowl.

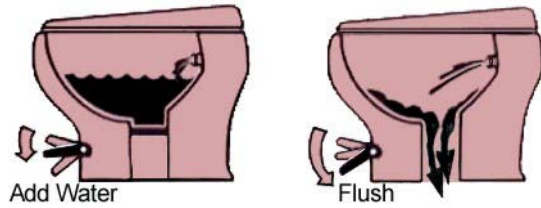

Important “Don’ts”

- Don't use facial tissue or regular toilet tissue in the RV toilet. These will not disintegrate sufficiently and will often cling to the sides of the holding tank. Toilet tissue made specifically for use in RV toilets and holding tanks is available at most RV supply centers.
- Don't dispose of sanitary napkins or other non-dissolving items in the toilet.
- Don't put automotive antifreeze or caustic chemicals, such as laundry bleach or heavy detergents into the toilet or holding tank. These products may damage plastic or rubber parts in the system.

See winterizing instructions at the end of this section to prepare the toilet for storage in freezing conditions.

Further Information

See the toilet manufacturer's operation information in your InfoCase for complete operating, care, and maintenance information.

TOILET - ELECTRIC FLUSH

-If Equipped

Your coach may be equipped with an electric macerating toilet, which provides powerful, yet whisper quiet operation. It is equipped with a wall-mounted push button control and operates on minimal water consumption.

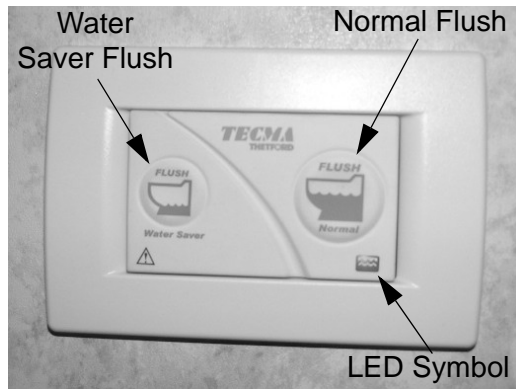

Wall Switch/Controller
(Located on wall near toilet)

Water Saver Flush Button

- Press and release to flush liquids and small amounts of toilet paper.

Normal Flush Button

- Press and release to flush solids and toilet paper.

NOTE: Press both Water Saver Flush and Normal Flush buttons simultaneously and release to empty bowl and leave it dry for travel. Press either button once to return to normal use.

LED Symbol

- Symbol not lighted - Toilet is OFF, in sleep mode, or not receiving power.
- Symbol lighted GREEN - Toilet is ON and the holding tank is between empty and half full.
- Symbol lighted YELLOW - Toilet is ON and the holding tank is at least half full.
- Symbol lighted RED - Toilet system is ON and the holding tank is full.

Important “Don’ts”

- Don't use facial tissue or regular toilet tissue in the RV toilet. These will not disintegrate sufficiently and will often cling to the sides of the holding tank. Toilet tissue made specifically for use in RV toilets and holding tanks is available at most RV supply centers.
- Don't dispose of sanitary napkins or other non-dissolving items in the toilet.

- Don't put automotive antifreeze or caustic chemicals, such as laundry bleach or heavy detergents into the toilet or holding tank. These products may damage plastic or rubber parts in the system.

See winterizing instructions at the end of this section to prepare the toilet for storage in freezing conditions.

Further Information

See the toilet manufacturer's operation information provided in your InfoCase for complete operating, care, and maintenance information.

WASTE WATER SYSTEM

(Holding Tanks)

The drainage system is self-contained and uses two separate holding tanks to contain the waste water until it can be dumped at an appropriate waste water disposal site. This means you can use the toilet, sinks and shower even in areas where utility hookups are not available.

The black water holding tank contains the sewage from the toilet and may include bathroom lavatory on some models. The gray water holding tank contains the waste water from the galley sink and shower, and may include bathroom lavatory.

See *Specifications* in Section 1–Introduction for tank capacities for your model.

Dumping Holding Tanks

The waste drain (sewer) hose features a convenient handle and valve nozzle for sanitary handling and improved waste disposal.

1. Remove the dust cap from the drain outlet and connect the sewage drain hose. Twist to lock the hose end hooks onto the pegs on the drain outlet. Be sure it is firmly attached.

NOTE: The dump valve drain outlet swivels downward when necessary to avoid bends in the drain hose which could trap solids while dumping or to provide more direct drainage while using on-site sewer hook-ups.

2. Push the handle forward to open the hose end valve, then extend the hose and place the nozzle into the disposal opening.



NOTE: The hose end valve (handle) must be opened before pulling the hose to the disposal opening. If the valve is closed, a vacuum will develop and prevent the hose from expanding fully.

Do not open holding tank valves until the hose end valve is open. If you open the dump valve before the hose valve, the hose will fill with sewage water and become difficult to move or could become clogged.

3. Open the sewage tank valve (black handle) with a quick pull. Move hose gently about to dislodge any waste and to ensure complete drainage. Close the valve as soon as the tank is empty.

NOTE: DO NOT OPEN BOTH VALVES AT ONCE. Do not open the gray tank valve until the black tank is drained and dump valve closed to avoid sewage back-up

into gray tank. Gray water also rinses any black water solids from the drain hose.



Holding Tank Valves (Typical)

NOTE: Black and Gray tank valve positions may be reversed depending on floorplan and tank location.

4. Open waste water dump valve (gray handle) with a quick pull. Close valve handle as soon as tank is empty.
5. After both tanks have been drained, flush the black water tank as described in “Flushing Your Black Water Holding Tank” following this procedure. (If hose is not available, run several gallons of water into the sewage tank through the toilet. Then open sewage dump valve and drain the tank again. Close valve when done).
6. Close hose valve by pulling handle up until lock snaps into place.
7. Rinse end of sewer hose thoroughly with water and stow.



NOTE: If the hose will not collapse while storing, open the hose end valve (handle) to release air trapped inside the hose.

- It is advisable to add an odor control chemical to the sewage holding tank. These chemicals are available at most RV supply stores.

NOTE: We recommend that you dump all holding tanks before traveling to avoid carrying unnecessary weight.

Flushing your Black Water Holding Tank

The black water holding tank is equipped with an internal spray head that allows you to rinse the inside of the tank with a shower of clean water after dumping.

- Dump your black water holding tank in the usual manner at approved sewage disposal station.
- Leave black water dump valve open while flushing tank.
- Attach a garden hose from a city water hydrant to the Flushing System inlet fitting in the water service center. (This inlet is clearly marked separate from the City Water inlet).



Black Water Tank Flush Inlet
(Located in water service center)
-Typical View

- Turn the water on to begin flushing; allow water to run for about three minutes.
- Disconnect hose from flushing system and close dump valves.

Using On-Site Sewer Hook-Ups

The drain hose may remain attached to the dump outlet and be routed out the flip-down hatch in the bottom of the compartment while the motor home is parked and connected to an on-site sewage hook-up.

The center outlet section may be swiveled downward for better hose alignment and drainage.

NOTE: Always keep service access passage closed while utility connection is not in use.

When using a sewer hook-up, keep the dump valves closed until a tank becomes full or when preparing to leave the site. This keeps the solids in suspension, allowing them to be carried out with the liquids when the dump valve is opened.

If the valve is left open, the liquids will drain off, leaving solids in the tank. Should this accidentally happen, disconnect the hose, fill the tank about half full with water, and drive a few miles to dislodge the solids. A few starts and stops will aid in the process. Then reconnect the hose and drain in the normal manner.

Holding Tank Level Indicators

See *Systems Monitor Panel* in Section 4–Appliances for further information on the monitor panel and checking tank levels.

See *Specifications* in Section 1–Introduction for tank capacities for your model.

UTILITY LIGHT

A light is located up on the left sidewall to illuminate the utility hook-up area when needed.

The switch is located in the water service center compartment.

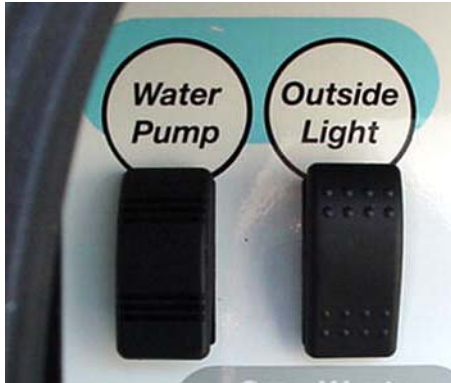

WATERLINE AND TANK DRAIN VALVES

The water drain valves are used to drain water from the water tank and the water supply lines when preparing the motor home for storage or when sanitizing the water system.

To Drain Tanks and Waterlines

The waterline and tank drain valves are located inside driver and passenger side compartments (see Water System Drain Valve Locations chart at the end of this section for locations on your model).

Turn the Fresh Water Valve to TANK FILL position, then remove the caps from the ends of the drain hoses and turn the valves to drain waterlines.

Water Tank Drain Valve



Water Tank Drain Valve
(Located in first passenger side compartment)
-Typical View

Water Heater Drain Plug (Not available on Models 40CD and 42AD)

The water heater drain plug is located on the outside of the coach behind the water heater service panel. Use a socket to remove the plug.



Water Heater Service Access
-Typical View

WATER HEATER BYPASS VALVE

-If Equipped

(Not available on Models 40CD and 42AD)

Your coach may be equipped with a water heater bypass valve for easier winterization of waterlines using RV antifreeze. See Water System Drain Valve Locations chart at the end of this section for valve location on your model.

Turn the handle as shown to either Bypass or Normal flow through the water heater.



Leave bypass valve handle in **NORMAL FLOW** position if draining water and blowing out waterlines. Place in **BYPASS** position **ONLY** when using antifreeze solution in waterlines.

WINTERIZING PROCEDURES

You can winterize the water and plumbing system of your coach using one of the following two methods – 1) Blow out waterlines using compressed air or – 2) Fill waterlines with RV water system antifreeze.

Method 1 – Blow Out Procedure (Drain and purge waterlines using compressed air)

This procedure is NOT to be performed with coaches equipped with the Aqua-Hot Hydronic Heating System!

NOTICE

Do not blow out Aqua-Hot hydronic heating system. Failure to comply may result in system damage.

1. **Level the Motor Home.** If the coach is not level, there may be “low points” in waterlines that can trap water in the lines and prevent it from draining properly.
2. **Drain Fresh Water Tank and Waterlines.** Open all waterline drain valves and drain fresh water tank. (See “Water System Drain Valve Locations” chart at end of this section for locations of drain valves on your model.)
3. **Drain Exterior Shower/Wash Station.** Open exterior shower knobs and lay shower head on ground as shown to drain any water left in the shower line. Also place the tip of your finger into the city water inlet and gently press the backflow valve “button” in the center of the inlet to drain any water trapped in the inlet line.



Using Exterior Shower to drain waterline
-Typical View

4. **Remove the Water Filter Cartridge (if equipped).** Remove the filter cartridge from the filter assembly below the galley sink. *(If your coach is not equipped with a filtered water faucet, proceed to the next numbered step.)*



Water Filter Assembly
(Located below galley sink)

- Twist the filter cartridge counter-clockwise (left) about a quarter-turn and pull it down and out of the filter socket.
5. **Remove Full-Coach Water Filter (if equipped).** Remove the filter canister from the full-coach water filtration system in the water center compartment (if equipped) and discard the filter cartridge. *(If your coach is not equipped with a full-coach water filtration system, proceed to the*

next numbered step.)

After emptying the canister, remount it onto the filter assembly and continue the Blow-Out Procedure.

6. **Open Faucets.** Turn the Water Pump switch ON and open all sink faucets and shower head knobs. Leave open after water stops flowing.
7. **Drain Toilet.** Press the toilet flush pedal (or “Normal Flush” button on the wall control, if your coach is equipped with an electric flush toilet) and hold until water stops flowing in the toilet. Then turn water pump switch OFF.
8. **Drain Optional Appliances.** At this time, if your coach is equipped with an optional refrigerator ice maker, dishwasher, or washer/dryer, the waterlines for these appliances must also be drained. *(See “Winterizing Optional Appliances” instructions at the end of this section.)* If not, proceed to the next step.
9. **Drain Water Heater.** Turn OFF the Water Heater switch before draining the water heater tank to avoid damage to the heating element. Drain the water heater by removing the plug from the base of the water heater tank, accessible from the outside of the coach. *(Requires socket and ratchet).*



Water Heater Drain Plug
(Remove with socket)

Also, open the Pressure-Temperature Relief Valve at the top right portion of the tank to prevent air locking in the tank while draining.

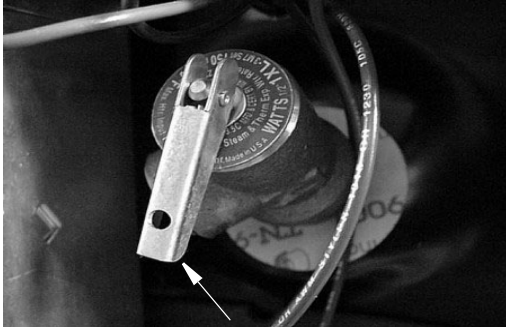

Pressure-Temperature Relief Valve
(Lift handle only when water heater is cold)

10. **Connect Air Pressure.** After water has stopped draining at all faucets and drain valves, leave faucets open and connect a “blow-out” plug to the city water connection on the coach. Then use a compressed air hose regulated to 30 psi or less to force air through the system. A blow-out plug can be purchased at any Winnebago® or Itasca® dealership.

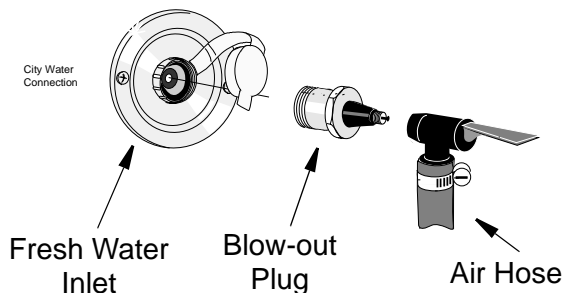

NOTICE

Limit air pressure to 30 psi to avoid damage to equipment.

NOTE: DO NOT burst air into the system. This can damage the water pump. It is better to let air in slowly.

11. **Let air flow for five minutes** until water is completely drained out of faucets and drain valves. Then close faucets one at a time.

12. **Drain Toilet.** Press and hold toilet flush lever (or “Normal Flush” button on the wall control, if your coach is equipped with an electric flush toilet) until water is completely drained from toilet.
13. **Turn air pressure off.** Disconnect water purge adapters. Recap the city water inlet to avoid contamination by dirt or insects.

After Disconnecting Air Pressure

14. Empty the full-coach water filter canister of any water trapped during blow-out procedure. Remount empty canister onto filter assembly. *(If not equipped with a full-coach water filter system, continue to next numbered step).*
15. Close all waterline and tank drain valves and all faucets to avoid contamination by dirt, insects, or rodents.
16. Reinstall the Water Heater drain plug and close the P-T Relief Valve.
17. Pour about one cup of RV antifreeze down each drain for the galley sink, lavatory sink, and shower/tub. This fills the drain trap pipes to prevent holding tank odors from entering the coach during storage.

NOTE: It is not necessary to add antifreeze to the toilet since the flush valve will be closed.

Do not add automotive antifreeze or caustic chemicals such as bleach or laundry detergents into the toilet bowl or holding tanks. Although these products may have a deodorizing effect, they may damage plastic and rubber parts in the system.

18. Empty the water pump strainer filter bowl to avoid water freezing and cracking the filter bowl. See “Water Pump” previously in this section.

Dump and Clean Holding Tanks

19. Completely drain the sewage and waste water holding tanks at an approved waste disposal site. Drain the sewage tank first so the following waste water can rinse any waste solids from the sewage drain outlet and sewer hose.

20. Flush the sewage tank using the Black Waste Tank Flush Inlet (if equipped).

21. Close dump valves and refit the dust cap onto the drain outlet.

This will inhibit rust formation on valve shafts and prevent entry and contamination by airborne debris, insects, and rodents.

Your drainage and fresh water systems are now completely winterized.

See instructions for “Removal From Storage” in Section 11 - Maintenance.

Method 2 – Antifreeze Fill Procedure

(Fill plumbing lines with RV water system antifreeze)

This procedure may be performed on all models, but MUST be performed on Models 40CD and 42AD (with the Hydronic Heating System)

NOTE: As an alternative to totally draining the waterlines, you may winterize tanks and waterlines by filling them with non-toxic RV water system antifreeze through the plumbing system.

This product is available from your dealer and from most RV supply stores and national retail outlets.

Follow directions on the container to determine the correct amount to use for your coach.

Your coach is equipped with a manually operated waterline winterization system for your convenience in winterizing fresh waterlines.

The system features a diverter valve with siphon tube to draw non-toxic RV water system antifreeze into the waterlines. There is also a water heater bypass valve to avoid filling the water heater with antifreeze (not available on Models 40CD and 42AD). This feature is located near the water pump in the water center or utility compartment.

Leave water heater bypass valve handle in NORMAL FLOW position if draining water and blowing out waterlines. Place in BYPASS position ONLY when using antifreeze solution in waterlines.

	WARNING
<p>NEVER use automotive antifreeze/coolant in your RV water system. Auto antifreeze contains ethylene glycol which, if ingested, can cause blindness and can be fatal.</p>	

Remove Water Filters (if equipped)

Before pumping RV antifreeze into water system, remove water filter cartridges (if equipped).

1. Remove and discard the filter cartridge from the filtered water faucet assembly (if equipped) below the galley sink.
(If your coach is not equipped with a filtered water faucet, proceed to the next numbered step.)



Water Filter Assembly
(Located below galley sink)

- Twist the filter cartridge counter-clockwise (left) about a quarter-turn and pull it down and out of the filter socket.

NOTE: The water filter head has a built-in bypass. No separate diverter plug is needed.

- Remove the filter canister from the full-coach water filtration system in the water center compartment (if equipped) and discard the filter cartridge.

(If your coach is not equipped with a full-coach water filtration system, proceed to the next numbered step.)

After removing filter, remount the empty canister onto the filter assembly and continue the antifreeze fill procedure.

Set Up Winterization Valves

- Turn Winterization Valve 1 to “Water Heater Bypass” position to avoid filling water heater with antifreeze.



See Water System Drain Valve chart at the end of this section for location on your coach

*** Not available on Models 40CD and 42AD**

- Place handle of Winterization Valve 2 in the “Winterize” position.



See Water System Drain Valve chart at the end of this section for location on your coach

- Remove and save the protective cap from the end of the antifreeze siphon tube (which connects to Winterization Valve 2). Insert the end of the siphon tube into a pail or other container with 2 to 3 gallons of non-toxic RV antifreeze solution.

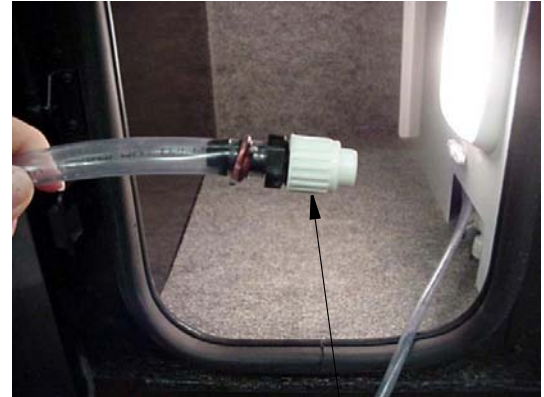

RV Antifreeze Siphon Tube
(Located near water pump)
* Insert into container of RV water system antifreeze)

Fill Lines

- Turn the Water Pump switch ON.
- Open each hot and cold water faucet handle/knob in the coach – one at a time each in turn until antifreeze solution just begins to flow from the faucet, then close.
Do not forget exterior shower/wash station knobs (if equipped).
- Press the toilet flush pedal (or “Normal Flush” button on the wall control, if your coach is equipped with an electric flush toilet) and hold until antifreeze begins flowing into the toilet. Leave small amount of antifreeze that remains in the bowl.

When Done Adding RV Antifreeze

- Turn Water Pump switch OFF.
- Turn the Winterization Valve 2 to “Normal”. This will stop the flow from the antifreeze siphon tube and revert the tank line flow to the pump.
- Replace the protective cap onto the end of the antifreeze siphon tube to keep out insects and debris when not in use.

Drain Water Heater

(Not available on Models 40CD and 42AD)

12. Turn off the Water Heater switch before draining the water heater tank to avoid damage to the heating element.
 - Drain the water heater by removing the plug from the base of the water heater tank, accessible from the outside of the coach. (Requires socket and ratchet).

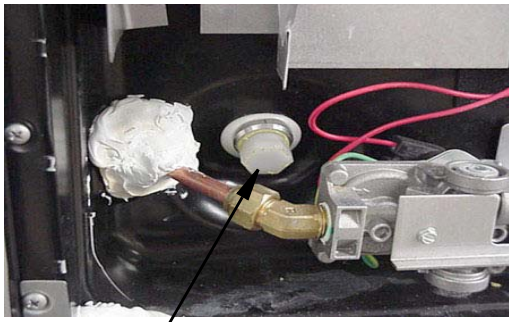

Water Heater Drain Plug
(Remove with socket)

- Also, open the Pressure-Temperature Relief Valve at the top right portion of the tank to prevent air locking in the tank while draining.

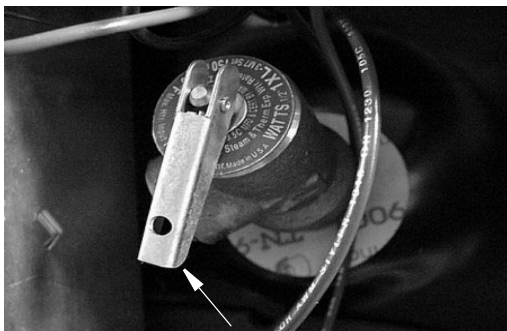

Pressure-Temperature Relief Valve
(Lift handle only when water heater is cold)

- Reinstall the Water Heater Drain Plug and close the P-T Relief Valve when drained.

Drain Appliances

13. At this time, if your coach is equipped with an optional refrigerator ice maker, dishwasher, or washer/dryer, the waterlines for these appliances must also be drained. (See “Winterizing Optional Appliances”

instructions at the end of this section.)
If not equipped with optional appliances, proceed to the next numbered step.

Close All Drain Valves

14. Close all waterline drains and tank drain valves to avoid contamination by dirt, insects, or rodents.
15. Pour about one cup of RV antifreeze down each drain for the galley sink, lavatory sink, and shower/tub. This fills the drain trap pipes to prevent holding tank odors from entering the coach during storage.

Dump and Clean Holding Tanks

16. Completely drain the sewage and waste water holding tanks at an approved waste disposal site. Drain the sewage tank first so the following waste water can rinse any waste solids from the sewage drain outlet and sewer hose.
17. Flush the sewage tank using the Black Waste Tank Flush Inlet (if equipped).
18. Close dump valves and refit the dust cap onto the drain outlet.
This will inhibit rust formation on valve shafts and prevent entry and contamination by airborne debris, insects, and rodents.

Your drainage and fresh water systems are now completely winterized.

See instructions for “Removal From Storage” in Section 11 - Maintenance.

**WINTERIZING OPTIONAL
APPLIANCES**

Winterizing Ice Maker

Norcold® Refrigerator

1. Drain coach waterlines.
2. Unscrew the water supply line from the bottom of the water inlet valve and drain any water left in the line. This connection is located in the refrigerator service access

compartment on the outside of the coach (see “Refrigerator Service Access Compartment” in *Section 4 - Appliances and Systems*).

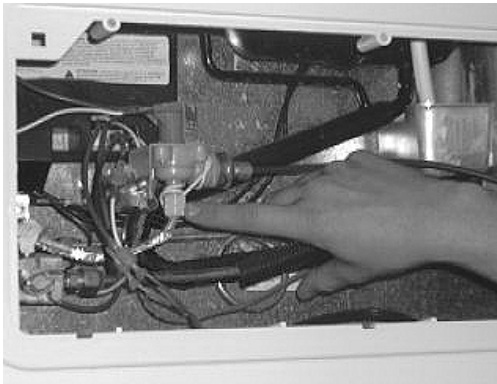

Ice Maker Water Supply Connection
(Located in refrigerator service access
compartment on outside of coach)
-Typical View

3. Let the Ice Maker run through a cycle, then raise the wire shut-off arm to the OFF position.
4. Ensure water has drained from the Ice Maker supply line, then reconnect to inlet valve.
5. Ice Maker is now winterized.

To use Ice Maker again after seasonal storage:

1. Flush antifreeze from the waterlines (if antifreeze fill winterization procedure was performed).
2. Close all drain valves.
3. Turn the water supply ON.
4. Ensure the ice bin is in place and the wire shut-off arm is lowered to the ON position.
5. Let the refrigerator cool down to ice making temperature. Remember, this can take up to 24 hours.
6. Let the Ice Maker cycle and dump the first batch of ice.

Winterizing Washer/Dryer (Stackable) -If Equipped

Method 1 – Drain Water

If you have decided to completely drain the coach waterlines, follow these steps to winterize your Washer/Dryer:

1. With the Washer/Dryer power OFF, pour 1/2 quart of RV-type antifreeze into the Washer drum.
2. Close door. Advance Cycle Selector to “B”.
3. Press ON/OFF button, then press START. Let the Washer/Dryer run for 1 to 2 minutes.
4. Press ON/OFF button to turn power OFF.
5. Unplug Washer/Dryer from electrical outlet (or disconnect power).
6. Turn Water Supply Faucets OFF. Disconnect inlet hoses from faucets.
7. Drain remaining water from hoses. Finished.

To use Washer/Dryer again after seasonal storage:

1. Reconnect water inlet hoses to corresponding HOT/COLD faucets. Turn faucets ON.

NOTE: Check water inlet hoses and pump periodically (see manufacturer’s user guide for further information).

2. Plug Washer/Dryer into electrical outlet (or reconnect power).
3. With Washer/Dryer power OFF, pour 1/2 TBSP. of powder detergent (or liquid equivalent) into “Compartment 2” inside Dispenser Drawer.
4. Advance Cycle Selector to “Position 9”.
5. Press ON/OFF button, then press START.
6. Allow machine to run through the complete cycle to clean out any remaining antifreeze. Finished.

Method 2 – Fill with RV Antifreeze

If you have decided to fill the coach waterlines with RV antifreeze, follow these steps to winterize your Washer/Dryer:

1. With machine power OFF, advance Cycle Selector to “Position 3”.
2. Press ON/OFF button, then press START. Let machine fill until the drum turns (this could take up to 1 to 2 minutes).
3. Press ON/OFF button to turn power OFF.
4. Advance Cycle Selector to “B”.
5. Press ON/OFF button, then press START.

6. After letting antifreeze drain completely from drum, press the ON/OFF button to turn power OFF. Finished.

To use Washer/Dryer again after seasonal storage:

1. Reconnect water inlet hoses to corresponding HOT/COLD faucets. Turn faucets ON.

NOTE: Check water inlet hoses and pump periodically (see manufacturer's user guide for further information).

2. Plug Washer/Dryer into electrical outlet (or reconnect power).
3. With Washer/Dryer power OFF, pour 1/2 TBSP. of powder detergent (or liquid equivalent) into "Compartment 2" inside Dispenser Drawer.
4. Advance Cycle Selector to "Position 9".
5. Press ON/OFF button, then press START.
6. Allow machine to run through the complete cycle to clean out any remaining antifreeze. Finished.

**Winterizing Washer/Dryer
(Combination)**

–If Equipped

Method 1 – Drain Water

If you have decided to completely drain the coach waterlines, follow these steps to winterize your Washer/Dryer:

1. With the Washer/Dryer power OFF, pour 1/2 quart of RV-type antifreeze into the Washer drum.
2. Close door. Advance Cycle Selector to SPIN.
3. Press ON/OFF button, then press START. Let the Washer/Dryer run for 1 to 2 minutes.
4. Press ON/OFF button to turn power OFF.
5. Unplug Washer/Dryer from electrical outlet (or disconnect power).
6. Turn Water Supply Faucets OFF. Disconnect inlet hoses from faucets.
7. Drain remaining water from the hoses. Finished.

To use Washer/Dryer again after seasonal storage:

1. Reconnect water inlet hoses to corresponding HOT/COLD faucets. Turn faucets ON.

NOTE: Check water inlet hoses and pump periodically (see manufacturer's user guide for further information).

2. Plug Washer/Dryer into electrical outlet or reconnect power supply.
3. With Washer/Dryer power OFF, pour 1/2 TBSP. of powder detergent (or liquid equivalent) into "Compartment 2" inside Dispenser Drawer.
4. Advance Cycle Selector to "Position 9".
5. Press ON/OFF button, then press START.
6. Allow machine to run through the complete cycle to clean out any remaining antifreeze. Finished.

Method 2 – Fill with RV Antifreeze

If you have decided to fill the coach waterlines with RV antifreeze, follow these steps to winterize your Washer/Dryer:

1. With machine power OFF, turn Wash Temp knob to HOT.
2. Advance Cycle Selector to "Position 3".
3. Press ON/OFF button, then press START. Let machine fill until the drum turns (this could take up to 1 to 2 minutes).
4. Press ON/OFF button to turn power OFF.
5. Advance Cycle Selector to SPIN.
6. Press ON/OFF button, then press START.
7. After letting antifreeze drain completely from drum, press the ON/OFF button to turn power OFF. Finished.

To use Washer/Dryer again after seasonal storage:

1. Reconnect water inlet hoses to corresponding HOT/COLD faucets. Turn faucets ON.

NOTE: Check water inlet hoses and pump periodically (see manufacturer's user guide for further information).

2. Plug Washer/Dryer into electrical outlet or reconnect power supply.

3. With Washer/Dryer power OFF, pour 1/2 TBSP. of powder detergent (or liquid equivalent) into “Compartment 2” inside Dispenser Drawer.
4. Advance Cycle Selector to “Position 9”.
5. Press ON/OFF button, then press START.
6. Allow machine to run through the complete cycle to clean out any remaining antifreeze. Finished.
4. Set the controls to the end of the Rinse cycle to pump the liquid out of the Dishwasher to make sure the lines and pump contain antifreeze.
5. Turn Dishwasher controls to OFF.
6. Pour approximately one quart of RV water system antifreeze directly into the Dishwasher to ensure protection of pump and drain lines.
7. Dishwasher is now winterized.

Winterizing Dishwasher

–If Equipped

Follow manufacturer’s instructions provided in your InfoCase for operating and for interrupting cycles.

1. Empty all dishes from the Dishwasher.
2. Follow coach winterization instructions for using the winterization valve to draw RV water system antifreeze into the water system so antifreeze can enter the Dishwasher.
3. Set the Dishwasher controls to the start of the Rinse cycle and run briefly until antifreeze can be seen inside the dishwasher.

To use Dishwasher again after seasonal storage:

1. Flush antifreeze from the waterlines (if antifreeze fill winterization procedure was performed).
2. Set the Dishwasher controls to the start of the Rinse cycle and run briefly until antifreeze can be seen inside the dishwasher.
3. Set the controls to the end of the Rinse cycle and allow the machine to run through the complete cycle to clean out any remaining antifreeze.

WATER SYSTEM DRAIN VALVE LOCATIONS	
SYSTEM	DRAIN VALVE LOCATION
Waterlines	<ul style="list-style-type: none"> • Remove two (2) waterline caps located in the water pump compartment (second compartment on left side). • Open exterior shower faucet and lay shower head on ground. <i>Also, to drain any water left in the city waterline, place the tip of your finger inside the city water connection and gently press the backflow valve (small “button” in center of connector).</i>
Water Tank	<ul style="list-style-type: none"> • One (1) valve in the first compartment door on right side. Turn to drain.
Water Heater <i>(Not available on coaches equipped with Hydronic Heating System)</i>	<ul style="list-style-type: none"> • Models 40BD and 40WD: Drain plug on outside of coach behind service door. Use socket to remove drain plug.
Winterization Valve 1 * Water Heater Bypass <i>(Not available on coaches equipped with Hydronic Heating System)</i>	<ul style="list-style-type: none"> • Model 40BD: Remove panel in rear wardrobe on driver side to access. • Model 40WD: Behind cabinet door below washer/dryer.
Winterization Valve 2 * Antifreeze Siphon	<ul style="list-style-type: none"> • Valve with clear vinyl siphon tube is located in the water pump compartment (second compartment on left side).

TOUR

SECTION 8 – ENTERTAINMENT

HIGH DEFINITION VIDEO SELECTION SYSTEM -If Equipped

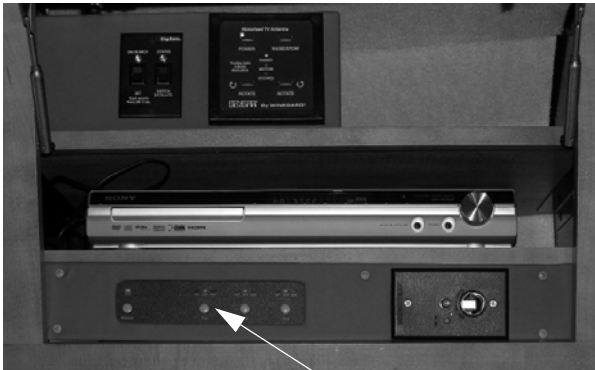

High Definition Video Selection Box
(Typical View)

The video selection system allows you to watch standard or high definition video from multiple sources on multiple TV's at the same time. You can select either DVD, Satellite, or Aux AV Component. TV's connected to this system are the main TV, 2nd main TV (if equipped), and the exterior entertainment center TV (if equipped).



To Watch DVD

- Power “ON” TV and the high definition video selection box.
- Power “ON” the DVD player.
- Determine which TV you want to use (e.g. TV2 for second main TV) and select “DVD” from high definition video selection box.
- On TV remote control, press INPUT or SOURCE button and select either COMPOSITE (for standard definition) or COMPONENT (for high definition).

The TV will display the DVD logo when the correct input is selected.

To Watch Satellite TV (Dish) -If Equipped

- Connect satellite receiver to accessory connection cables (provided in the prep area).



Accessory Connection Cables

- Power “ON” TV and the high definition video selection box.
- Determine which TV you want to use (e.g. TV1 for main TV) and select “SAT” from the high definition video selection box.
- On TV remote control, press INPUT or SOURCE button and select either COMPOSITE (for standard definition) or COMPONENT (for high definition).

The TV will display the satellite logo when the correct input is selected.

To Watch Broadcast TV (Antenna)

- Power “ON” the TV Signal Amplifier Power Switch. All TV's in the coach will now be connected to the roof antenna (via coax cable) and set TV to be viewed through antenna input.

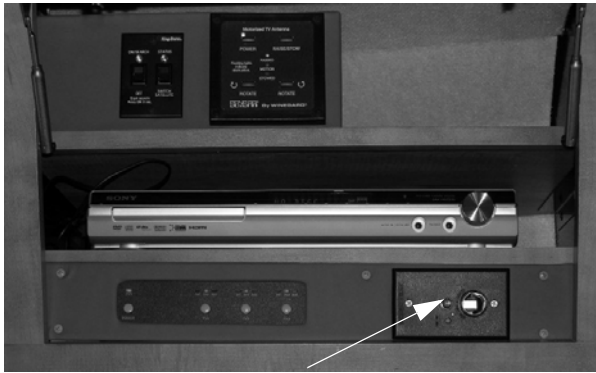

**TV Signal Amplifier Power Switch
(Typical View)**

To Watch Cable TV

- Power “OFF” the TV Signal Amplifier Power Switch. All TV’s in the coach will now be connected to the cable TV (via coax cable) and set TV to be viewed through cable TV input.

FRONT TV IGNITION SWITCH INTERLOCK

–If Equipped

If your coach is equipped with a front overhead TV, it is plugged into a special electrical outlet with a built-in ignition switch interlock. The device allows the front overhead TV to operate only when the ignition key is in the Off or Accessory positions.



**Front TV Ignition Switch Interlock
-Typical View**

AUDIO-VIDEO SYSTEM BASIC OPERATION

NOTE: For your convenience, we have also included a handy, tear-out version of this “A/V System Basic Operation” guide in Section 8 of your Operator’s Manual Supplement. See your InfoCase for specific operating guides for audio and video components.

**DVD HOME THEATER SYSTEM
–If Equipped**



The available DVD home theater system operates from 120-volt AC household current only, so you must have either the shoreline connected, the generator running, or the inverter turned on (if equipped).

The TV is connected to the home theater system, which plays through theater speakers in the lounge area of the coach.

Set TV Video Input

- Turn on the TV, DVD player, and Video Selection box. (Switch the Video Selection box to DVD for the TV that you are going to use).
- Press INPUT button on the remote or front of TV and select the DVD input channel on the TV.
Sony®: “Video 1 or Component 2”
- The TV screen will display the DVD player logo when the correct input is selected.



Play DVD with Theater Sound

- Insert DVD into player. DVD will begin to load automatically. TV screen will typically show “READING” or “LOADING”.
- The DVD may load directly to the main title/menu screen or it may begin to play previews. You may be able to skip previews if desired by pressing the chapter “advance” button until you see the main menu screen.
- When the main menu screen appears, use the arrow buttons on the remote to select the desired entry or press the ENTER or PLAY buttons on the remote (or “Play” button on DVD player) to begin playing the feature.
- Volume is adjusted with the DVD remote (or volume control on DVD player).



TV Sound through Home Theater Speakers

When watching TV programs (broadcast, cable, or satellite), the TV normally plays sound through its own built-in stereo speakers. To connect TV sound output to home theater speakers for a richer sound quality, follow these steps:

- Turn the TV and DVD player On.
- Select the TV channel you wish to watch.
- Press FUNCTION button on DVD player or remote to set DVD player to “TV/VIDEO”.
- Use the TV Menu button to set TV audio output to “Variable Audio Output” (See TV owner’s manual for instructions.) This will route TV stereo sound output through the home theater system.
- Adjust theater speaker master volume to maximum on the DVD, then control volume with the TV remote.

CD/DVD PLAYER - BEDROOM (& Stereo Radio Alarm Clock) -If Equipped



The TV operates from 120-volt AC household current only, so you must have either the shoreline connected, the generator running, or the inverter turned on (if equipped).

The DVD player is connected to the TV and plays through the TV stereo speakers.

Set TV Sound Output -If Equipped

- Use the TV Menu button to set TV audio output to Variable Audio Output (See TV owner’s manual for instructions.) This will connect TV stereo sound output to the deluxe speakers (if equipped).
- Volume is adjusted with the TV remote or volume buttons.

Set TV Video Input

- Turn TV and DVD player On.
- Press the SOURCE or INPUT button on the TV or TV remote to select “INPUT 1” or “AV1”.
- The TV screen will display the DVD player logo when the correct input is selected.

Play DVD

- Insert DVD into player. DVD will begin to load automatically. TV screen will typically show “READING” or “LOADING”.

- The DVD may load directly to the main title/menu screen or it may begin to play previews. You may be able to skip previews if desired by pressing the NEXT button until you see the main menu screen.

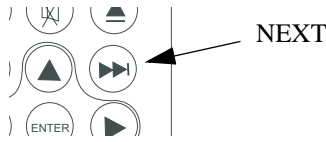

- When the main menu screen appears, use the arrow buttons on the DVD remote to select the desired entry or press the ENTER or PLAY buttons on the remote (or “Play” button on DVD player) to begin playing the feature.

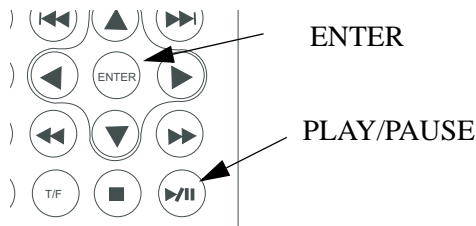

- Volume is adjusted with the DVD remote (or volume buttons on DVD player).

Further Information

For further information and operating instructions, see the manufacturer’s information included in your InfoCase.

**CD/DVD PLAYER
(& Stereo Radio)
Exterior Entertainment Center
–If Equipped**



The TV operates from 120-volt AC household current only, so you must have either the shoreline connected, the generator running, or the inverter turned on (if equipped).

The exterior entertainment center TV is connected to the exterior DVD player, video selection box, the rooftop antenna, and the park cable input.

Play DVD

- Turn TV and DVD player On.
- Press the SOURCE or INPUT button on the TV or TV remote to select INPUT 2 or AV2.
- The TV screen will display the DVD player logo when the correct input is selected.
- Insert DVD into player. DVD will begin to load automatically. TV screen will typically show “READING” or “LOADING”.
- The DVD may load directly to the main title/menu screen or it may begin to play previews. You may be able to skip previews if desired by pressing the NEXT button until you see the main menu screen.

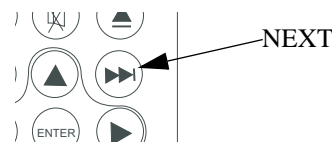

- When the main menu screen appears, use the arrow buttons on the DVD remote to select the desired entry or press the ENTER or PLAY buttons on the remote (or “Play” button on DVD player) to begin playing the feature.

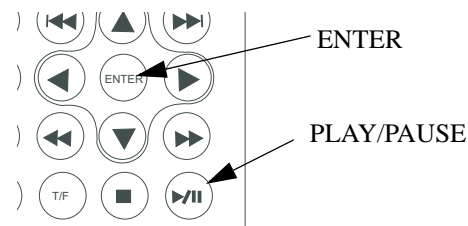

- Volume is adjusted with the DVD remote (or volume buttons on DVD player).

Antenna

- Turn On antenna booster inside coach.
- Turn On TV and tune to desired channel.



Cable

(Park cable input located in power cord compartment)

- Turn Off antenna booster inside coach. See above photo.
- Turn On TV and tune to desired channel.

Video Programming from the Video Selection Box

- Turn On video selection box and select desired input (Satellite, DVD, or Aux) for TV2.
- Turn On TV and press the SOURCE or INPUT button on the TV or TV remote to select INPUT1 or AV1.



Play TV Through Stereo Speakers

The exterior entertainment center TV is connected to the video selection box, the rooftop antenna, and the park cable input. To play this signal through the stereo speakers:

- Tune TV to desired channel or input.
- Turn On the radio and press the MODE button on the remote or the radio until it displays AV-IN1.
- Adjust the volume on the TV or the radio for desired level.

Further Information

For further information and operating instructions, see the manufacturer's information included in your InfoCase.

TV (BEDROOM) - POWER LIFT -If Equipped

Your coach may be equipped with a bedroom TV power lift/lower mechanism which allows you to raise and lower the TV with a touch of a switch.

There are two control switches equipped with this feature. One located near the TV and the other mounted on the bedroom nightstand. The following label is located near the TV.



1. To raise the TV, press the control switch UP and the TV will pop up through the access lid.



2. Raise TV to the height that best suits your viewing needs.



3. To lower the TV back into stored position, press the control switch DOWN. The power lift/lower mechanism will stop automatically when the TV is all the way seated into stored position.



4. Close the access lid by hand to protect the TV and to make for additional counter space.

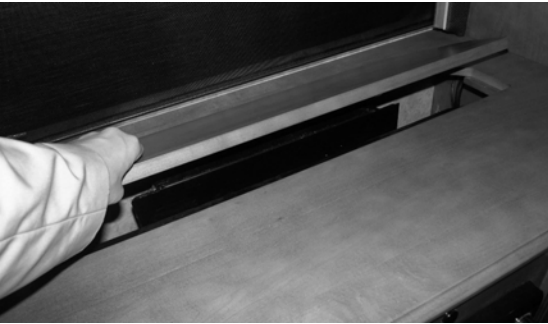

NOTE: Be sure that the counter is clear before raising/lowering the TV to protect the TV, lift/lower mechanism, and personal property from possible damage.

TV ANTENNA

The TV antenna on your motor home can be easily raised, rotated a full 360° and lowered from inside the vehicle by simply turning a crank or directional handle. A built-in signal amplifier designed to strengthen signals, is controlled by a power switch built into the optional video selector panel or on a wall plate assembly.

See the antenna manufacturer's operation, care and maintenance information in your InfoCase.

	WARNING
<p>Never allow the antenna to touch electrical power lines or any other electrical wires.</p>	

Raising Antenna to Operating Position

Turn elevating crank clockwise in “UP” direction until some resistance to turning is noted (about 13 turns). Antenna is now in operating position.

Turn amplifier power switch “ON” to receive TV signal.



Rotating Antenna for Best Picture

Make sure antenna is in the “UP” position. Pull down on directional handle using both hands until it disengages ceiling plate and rotate for best picture and sound on TV set.



Lowering Antenna to Travel Position

Rotate antenna until pointer on directional handle aligns with pointer on ceiling plate.

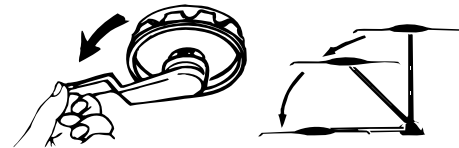

Turn elevating crank (counter-clockwise) in “DOWN” direction until resistance is noted (about 13 turns). Antenna is now locked in travel position. Turn amplifier power switch “OFF”.

CAUTION

To avoid equipment damage, always align directional handle to DOWN position before lowering. Never partially raise or lower antenna. Antenna must be raised fully up into operating position or lowered fully down into travel position.

TV SIGNAL AMPLIFIER

The TV signal amplifier is built into the antenna and can be turned on or off with a power switch located on a switchplate below or inside the front overhead entertainment center cabinet.

An indicator light will glow when the switch is on and the signal amplifier is active.



TV Signal Amplifier Power Switch
-Typical View

Checking Amplifier Performance

The TV signals available to an RV are entirely dependent on its location in relation to the transmitter. Signals may vary from strong to no usable signal at all. We recommend that the TV system be checked out in an area known to have good TV reception.

To check the antenna amplifier, raise the antenna, select a TV channel and rotate the antenna for best picture. Then turn off the amplifier power switch. If the antenna amplifier

is working properly, the TV picture will now be degraded (snowy). When you turn the switch back on, the picture should again be sharp.

TV DIGITAL SATELLITE SYSTEM – AUTOMATIC

-If Equipped

The Automatic Digital Satellite Television System allows you to receive TV programs directly from satellite to your coach. The programs are transmitted in digital format so the quality is equal to laser disc or CD.

We recommend that you read the satellite dish manual thoroughly to understand the system completely before attempting any setups or adjustments.

- The coach must be parked and level before attempting to operate the automatic antenna dish.
- There must be a clear “line of sight” to the satellite. Mountains, buildings, trees, telephone poles and other obstructions can all block the satellite signal from reaching the dish.
- When activated while parked, the dish antenna will seek the selected satellite automatically.
- Press the SAT switch on the HD Video Selection System to view the satellite signal. See HD Video Selection System for additional information.



Automatic Satellite Dish Control

Further Information

See the Automatic Satellite System owner’s manual in your InfoCase for complete description of features and instructions.

**TV DIGITAL SATELLITE DISH –
IN-MOTION**

–If Equipped

The In-Motion Digital Satellite Television System allows you to receive TV programs directly from satellite to your coach while driving down the road.

We recommend that you read the satellite dish manual thoroughly to understand the system completely before attempting any setups or adjustments.

- The In-Motion control switch must remain powered on to maintain a signal. If you are parked and wish to continue watching television, **DO NOT** turn Off the In-Motion system.
- There must be a clear “line of sight” to the satellite. Mountains, buildings, trees, telephone poles and other obstructions can all block the satellite signal from reaching the dish.



- Satellite seeking time can be reduced by setting the region code for your current location. Codes are shown in the manufacturer’s operating information.
- See the In-Motion Satellite System owner’s manual in your InfoCase for complete description of features and instructions.

**TV DIGITAL SATELLITE
SYSTEM WIRING**

This coach is pre-wired for installation of a digital satellite TV system. Coaxial cable and high definition component cable connections are available to hook up your satellite receiver and are located in the entertainment center cabinet.

A second connection may be included in an overhead cabinet in the bedroom for the rear TV (if equipped.)

See your authorized Winnebago Industries® dealer for proper installation and sealing of roof mounted components.



Interior Connection for Satellite Dishes
(Located in cabinet near TV)
- Typical View



High Definition Accessory
Connection Cables
(Located in cabinet near TV)

PORTABLE SATELLITE DISH AND CABLE TV HOOK-UPS (INPUT)

The portable satellite dish and cable television input connectors are located in the shoreline compartment.

The cable television and portable satellite dish input lines can be routed through the hatch in the bottom of the compartment so the door can remain shut while connected.



Exterior Connection for
Satellite Dish and Cable TV
(in the Shoreline Compartment)



Exterior Entertainment Center
-Typical View

Further Information

Please read the manufacturer's user guide in your InfoCase for complete operating instructions.

EXTERIOR ENTERTAINMENT CENTER

-If Equipped

The exterior entertainment center contains a TV, stereo radio/CD/DVD player, and audio/video hook-ups for your outdoor listening or viewing pleasure.

NOTE: These electronic devices and speakers are not designed to be waterproof. Please take measures to prevent rain or other precipitation from entering the entertainment center by closing the compartment door or ensuring that an awning will prevent entrance of precipitation.

TOUR

SECTION 9 – FURNITURE AND SOFTGOODS

LOUNGE CHAIR BASE CLAMP

While the vehicle is in motion, the base of the lounge chair must be fastened into position with a clamp on the floor as shown.



Lounge Chair Base Clamp
(Travel position shown)
-Typical View

When the vehicle is parked, you can unscrew the knob and remove the clamp to position the chair away from the wall.



WARNING

The chair must be clamped back into place and the glide mechanism locked (if equipped) before traveling.

TABLE AND CHAIRS

-If Equipped

Dinette Chairs

The dinette chairs are free-standing to allow greater freedom of movement than typical booth style dinettes or pedestal seats. Folding dinette chairs are also provided for additional seating when needed. The folding chairs are typically stored in the bedroom wardrobe or under the bed.

Free-standing chairs are not intended for occupancy while the vehicle is in motion.

Before driving, always return chairs to their storage location.

Dining Table Chairs



-Typical View

1. Push dining table chairs against opposite sides of table.
2. Bind chairs together with the provided strap in the figure eight pattern shown above.

Buffet Chairs



1. Push buffet table chairs against opposite sides of table.
2. Bind chairs together with the provided strap in the circular pattern shown above, ensuring the strap goes through the ring located in the bottom side of the table.

Pedestal Table

–If Equipped

The pedestal base of the dining table is fastened to the floor with a clamp as shown.



You can unscrew the knob and remove the clamp to position the table wherever you desire in the living area of the coach while the coach is parked.

Store the clamp assembly for future use to secure the table before traveling.

! WARNING

Properly secure all free-standing chairs, furniture, and loose items prior to driving. Moving items can cause driver distraction, possibly resulting in an accident that can result in death or serious injury.

SLEEPING FACILITIES

! WARNING

Sleeping facilities are not intended for use while vehicle is in motion. For safety, passengers must use safety belted seating positions while vehicle is in motion.

DINETTE/BED CONVERSION

–If Equipped

(Typical view – your coach may differ)

Dinette to Bed



1. Release the catch on the table leg brace and fold the leg up against the bottom of the table.



2. Remove the table from the wall support bracket by lifting the end of the table. Then lower the table to rest on the cleats attached to each dinette bench.



3. Arrange dinette cushions to cover bed area.



Bed to Dinette

1. Reattach the table onto the wall support and lower the table leg.

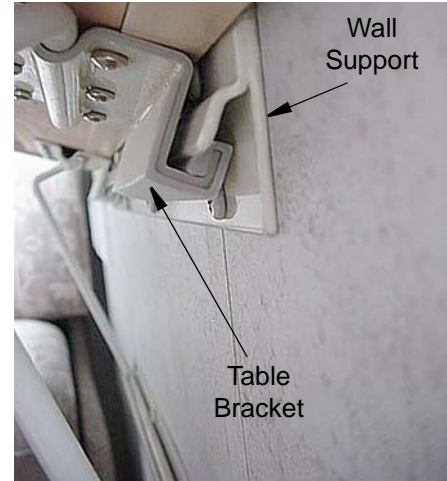

2. Make sure that the table leg is secured into the floor support bracket and the leg brace is locked.



BOOTH DINETTE - 40WD MODELS

–If Equipped

(Typical view – your coach may differ)



- The dinette table may be adjusted to the position that best suits your needs by moving the table slide mechanism forward or back.

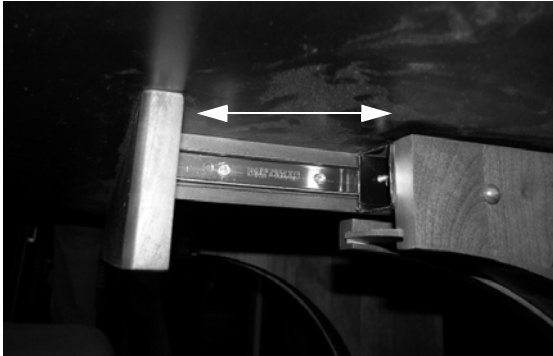

NOTE: When the vehicle is in motion, the travel latch must be in the locked position.

- Line up the latch mechanism with the table bracket hole and push upwards to engage.

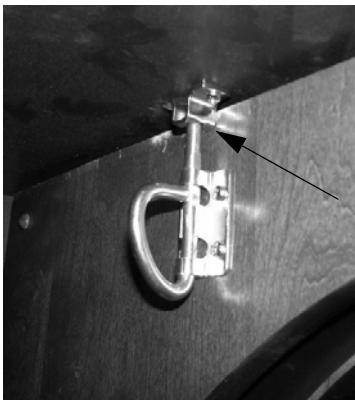

- Rotate the latch mechanism handle flat against the table support to ensure that the latch is secure.

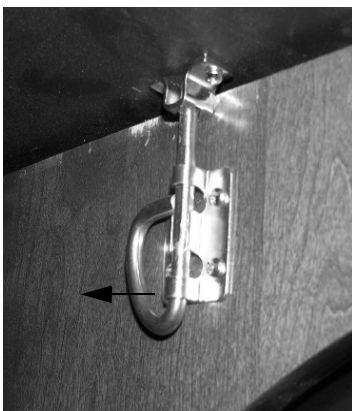

SOFA/BED CONVERSION

Sofa to Bed

Lift the front edge of the sofa seat upward and pull outward from the wall while gently pushing downward on the backrest until the cushions lie flat. The bed is now ready for use.

Bed to Sofa

Push the front edge of the seat toward the wall while lifting upward on the backrest until the sofa is fully seated against the wall.

SOFA/BED CONVERSION (with Removable Armrests)

–If Equipped

Couch to Bed

1. Remove the armrests from both ends of the couch by lifting upward. A “fin” on the underside of the armrest holds it in place between the cushion and side of the couch.



- Remove armrest by pulling upward

2. Lift the front edge of the sofa seat upward and pull outward from the wall while gently pushing downward on the backrest until the cushions lie flat. The bed is now ready for use.

Bed to Couch

1. Push the front edge of the seat toward the wall while lifting upward on the backrest until the sofa is fully seated against the wall.
2. Slide armrests into place at each end of the sofa.



- Slide “fin” on bottom of armrest down between cushion and side of couch

REST EASY® MULTI-POSITION LOUNGE –If Equipped



NOTICE

Do not recline the lounge completely flat unless the footrest section is extended.

To Recline

1. Press the switch on the front of the armrest. Press “down” to recline; “up” to return upright.

NOTE: Be sure house batteries contain adequate charge. If the batteries are partially discharged, the sofa may not fully recline or return to the upright position.



To Extend Pull-Out Footrest Section

1. Squeeze latch behind opening at top of lounge face panel and pull footrest trundle section out until it locks in the fully extended position.

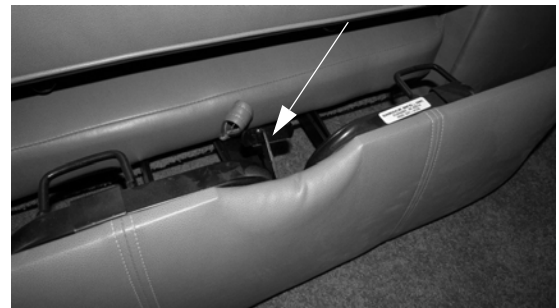

2. Grasp the pull strap (located on the front edge of the footrest) and lift footrest up and away from lounge until it is raised into position.

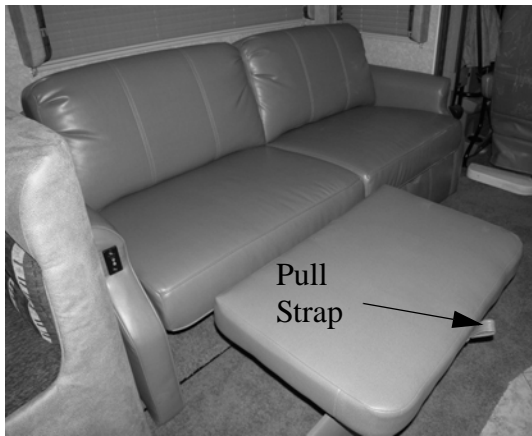

3. The gap between the footrest and seat should provide ample room to enter and exit the lounge. If you wish, however, you can unlatch the footrest and push it against the lounge seat.

NOTE: The footrest “drawer” will latch when pulled out completely and must be unlatched to push back in when stowing the footrest.



Tip for “power users”

- If you have the footrest section unlatched and positioned against the seat cushion, it will move out with the lounge when you press the recline switch.
- When you return to upright position, you can hook your heels over the front edge of the footrest section and pull it back with you.
- Then, when you want to get up, simply push the footrest section forward with your feet to provide a gap for you to exit.

To Convert to Bed

1. Extend footrest section and push together with lounge seat cushion,
2. then press recline button until entire lounge lies flat.
3. Reverse steps to return to lounge seating.



NOTICE

Do not recline the lounge completely flat unless the footrest trundle section is extended. Do not occupy the lounge when elevating the seat back from the flat bed position to upright lounge position. If house battery voltage is low, the mechanism may require assistance by lifting the seat back while returning upright from flat bed position.

! WARNING

Keep people away from operating mechanism and pinch hazard areas during use. Failure to do so could cause injury.

EXTENDABLE SECTIONAL SOFA

–If Equipped

Your coach may be equipped with an L-Shaped Sectional Lounge, which converts easily into additional seating space.

The sectional is also featured with the Rest Easy® powered lounge. See Rest Easy Multi-Position Lounge elsewhere in this section for complete operating instructions.

WARNING

Stow sectional sofa extension before retracting slide rooms. Failure to observe can cause injury and will cause equipment damage.

Extending Sofa Into L-Shaped Position

1. Pull UP and HOLD the black lever (located on the arm of the sectional) to release the sectional extension.



2. Fully extend the sectional extension.



3. Grasp the black pull strap (located on the front side of the sectional extension seat cushion) and pull UP and OUT.



4. Push front of seat cushion down, and then push rearward to secure the seat cushion into place.
5. Flip seat back support upright.



6. Install seat back cushion.



Reverse steps to store the sectional extension.



THEATER SEATING/BED CONVERSION –If Equipped

To Extend Pull-Out Footrest Section

1. Squeeze latch behind opening at top of lounge face panel and pull footrest trundle section out until it locks in the fully extended position.



2. Lift footrest up and away from lounge until it is raised into position.

NOTICE

Do not recline the lounge completely flat unless the footrest section is extended.

To Recline

1. Press the switch on the front of the armrest. Press “down” to recline; “up” to return upright.

NOTE: Be sure house batteries contain adequate charge. If the batteries are partially discharged, the sofa may not fully recline or return to the upright position.



3. The gap between the footrest and seat should provide ample room to enter and exit the lounge. If you wish, however, you can unlatch the footrest and push it against the lounge seat.

NOTE: The footrest “drawer” will latch when pulled out completely and must be unlatched to push back in when stowing the footrest.



Tip for “power users”

- If you have the footrest section unlatched and positioned against the seat cushion, it will move out with the lounge when you press the recline switch.
- When you return to upright position, you can hook your heels over the front edge of the footrest section and pull it back with you.
- Then, when you want to get up, simply push the footrest section forward with your feet to provide a gap for you to exit.

To Convert to Bed

1. Extend footrest section and push together with lounge seat cushion.
2. Press recline button until entire lounge lies flat.
3. Reverse steps to return to lounge seating.



NOTICE

Do not recline the lounge completely flat unless the footrest trundle section is extended. Do not occupy the lounge when elevating the seat back from the flat bed position to upright lounge position. If house battery voltage is low, the mechanism may require assistance by lifting the seat back while returning upright from flat bed position.

⚠ WARNING

Keep people away from operating mechanism and pinch hazard areas during use. Failure to do so could cause injury.

SLEEP NUMBER® BED

**by Select Comfort™
–If Equipped**

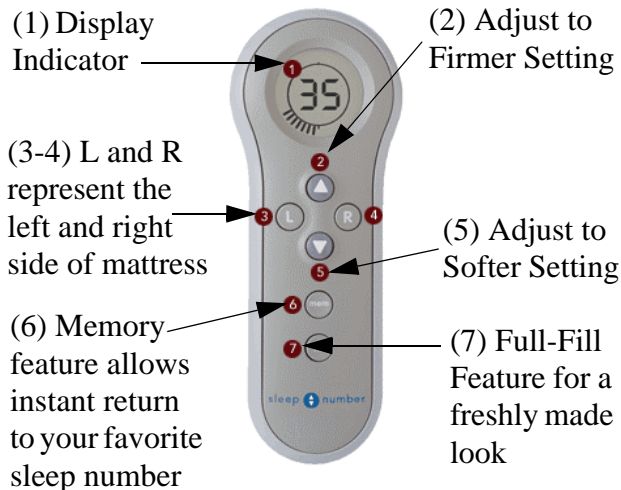

Wireless Sleep Number Remote Control

- A 9-volt battery is used in the wireless remote and should last approximately 6 months under normal use. Replace the battery when the low battery indicator is displayed.

NOTE: The Sleep Number bed operates on 120-volt AC household current only, so you must have the shoreline plugged in or the generator running to adjust the air pressure settings in this bed.

Further Information

For further information and operating cautions, see the Sleep Number bed operating instructions included in your InfoCase.

BED - POWER LIFT

–If Equipped

Your coach may be equipped with a power lift/lower mechanism that raises and lowers the head of your bed to best suit your comfort needs.

The power lift/lower control switch is located on the bedroom nightstand (some models may be equipped with a switch on each nightstand).

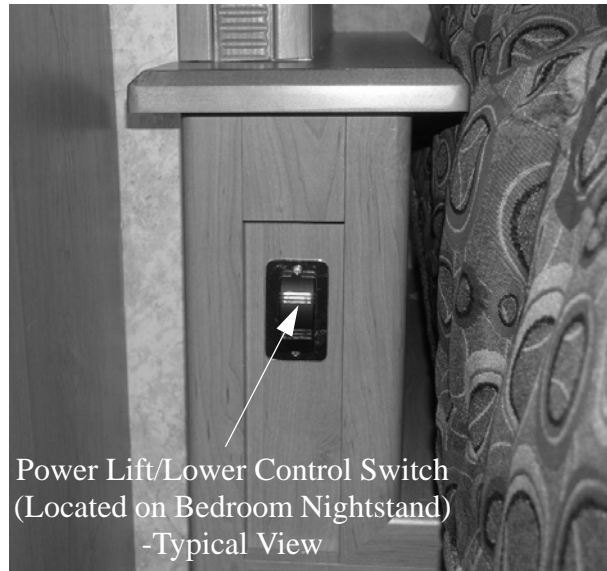

- Press the control switch UP to raise the head of the bed.
- Press the control switch DOWN to lower the head of the bed.

NOTE: This power lift/lower mechanism is equipped with an interlock feature, which will not allow you to retract the bedroom slideout unless the bed is in the fully upright position. The bed will also not recline unless the slideout is fully extended.

 WARNING
Keep people away from operating mechanism and pinch hazard areas during use. Failure to do so could cause injury.

DAY/NIGHT PLEATED BLINDS

–If Equipped

Your coach may feature two-stage pleated window blinds that can be used for light filtering, daytime room darkening, or nighttime privacy.

They are raised or lowered by grasping the bottom edge of the desired blind section and moving it up or down by hand.

A constant-tension cord system holds them at the desired level without slipping.

Sun Filter

The lower section is a translucent white shade that can be lowered for privacy without darkening the inside of the coach. It can also filter out harsh direct sunlight to help keep the inside of the coach cool in summer or to disperse light for houseplants.

Room Darkening/Privacy Shade

The upper section is an opaque, darkening shade for nighttime privacy and daytime room darkening purposes. Pull both sections down together or separately.

Tension Adjustment

The tension of the pleated blinds can be adjusted if they become loose and will not stay up when raised, or they are too tight and are difficult to raise and lower.

The tension cords are attached to spools at the lower corners of the blinds as shown in the following photo.



To Tighten Tension

Wrap the tension cords around the mounting spools, one turn at a time, at both ends of the shade. Check tension by raising and lowering a few times. Repeat as necessary to obtain the desired tension. Do not over-tighten.

To Loosen Tension

Unwrap the guide cords from the spools, one turn at a time, until desired tension is achieved.

Preserving Shape

The pleated blinds are made using high quality materials that are designed and woven to retain their shape throughout their useful life. They may lose their crisp shape, however, if left in a lowered position for an extended period of time without being raised periodically. If this happens, the pleats can be restored using this simple method.

- With the blind fully lowered, dampen the entire area of the pleats with a good quality laundry spray starch.
- Raise the blind fully while still damp and let it remain in the raised position for about 24 hours.
- Reapply starch periodically (every few months) as needed.

ROLLER SHADES (MANUAL) - SOLAR DAY/NIGHT

-If Equipped

Your coach may feature two-stage day/night roller shades that provide both solar heat protection and light-blocking capabilities.

The shade can easily be lowered by hand to any position, then retracted with a slight downward pull movement. When raising the shade, there is no need to hold onto the bottom of the shade - just simply let it go and it will rise at a slow, controlled rate.

You can pre-set the auto-stop positioning of your shade, which allows your shade to retract to a cushioned stop, at the positioning of your choice.



Further Information

For further operating information and care instructions, see the manufacturer's operating instructions included in your InfoCase.

WOOD FURNITURE AND CABINETRY

–If Equipped

People are drawn to the natural beauty of wood. At Winnebago Industries®, our craftsmen work with the art found in each piece of wood to create cabinets of superior quality, backed by the Winnebago Industries warranty.

- Oak is a strong, open-grained hardwood that ranges in color from white to pink and reddish tones. Streaks of green, yellow, and even black may appear due to mineral deposits. Oak may also contain wormholes and wild, varying grain patterns. This distinct graining is considered a desirable quality and has made oak one of the most popular woods used for cabinetry.
- Maple is a close-grained hardwood that is predominately white to creamy-white in color, with occasional reddish-brown tones. While maple typically features uniform graining as compared to other wood species, characteristic markings may include fine brown lines, wavy or curly graining, bird's eye dots and mineral streaks. These traits are natural and serve to enhance maple's natural beauty.
- Cherry is characterized by its red undertones, but may vary in color from white to a deep, rich brown. Cherry is a close-grained wood with fairly uniform texture, revealing pin knots and curly graining. All wood will age with time and the finish will darken. This is especially true for cherry. This is a sought-after quality in cherry cabinetry, and those who select it expect this evolution.

No matter which species you choose for your new Winnebago Industries motorhome cabinetry, please keep in mind that no two pieces of wood are exactly the same.

Stains are likely to exaggerate the difference between open and closed grains and other markings in wood. Grain variation and color change should be expected. As hardwood ages, it will darken when exposed to different types of light. Color differences or changes in wood can also be caused by exposure to harsh chemicals, extreme heat, or other contributing external conditions.

Any color change that occurs in both the finish and the wood is considered part of the natural aging process and is not to be considered defect or damage.

Additionally, wood species exhibit other defining characteristics, such as mineral deposits/streaks, knots, sap runs, pin holes, and wormholes. These markings make the wood unique and contribute to its enduring beauty.

Therefore, since wood is a product of nature and will have certain natural characteristics and variances, they are not covered under the warranty.

TOUR

SECTION 10 – SLIDEOUT ROOMS AND LEVELING

SLIDEOUT ROOM TRAVEL LOCKS - ELECTRIC

-If Equipped

Some models are equipped with electric Slideout Room Travel Locks on slideout rooms to restrict movement of the slideout room while the vehicle is in motion. The slideout room will not extend until the lock is fully released.

Slideout Room Travel Lock switches are located on a wall in an area near the slideout room or incorporated into the monitor panel, depending on model.



Slideout Room Travel Lock
(Your model may be equipped
with one or more types)
-Typical View

NOTICE

Release Slideout Lock before attempting to extend slideout room. The room will not extend until the lock is fully released. Fasten Slideout Lock before driving vehicle. See following instructions.

NOTE: *Be sure locks are fully released before attempting to extend or retract room. If the latch mechanisms are protruding more than 1/4", the room will not extend or retract and the slideout pump will run in idle/bypass mode.*

To Release

- Press and Hold the UNLOCK side of the Slideout Room Lock switch for about 7 seconds. (You may be able to hear the lock motor sound stop).

To Lock

- Press and Hold the LOCK side of the Slideout Room Lock switch for about 7 seconds. (You may be able to hear the lock motor sound stop).

Slideout Lock Drain Line

If your coach is equipped with electric Slideout Room Travel Locks, it is recommended to periodically inspect the slideout lock drain line (located near the top of the exterior slideout room).

NOTE: Depending on the length of your slideout room, there may be two Slideout Room Travel Locks. Therefore, two drain lines will need to be inspected (typically one located on each end of the slideout room).

It is possible for dirt and debris to collect inside the drain line and cause obstruction, not allowing water to drain properly. If the drain line is plugged, use a small tool (i.e. pipe cleaner) to dislodge any debris. Failure to comply may result in water backing up inside the drain line, resulting in water leaks and/or property damage.

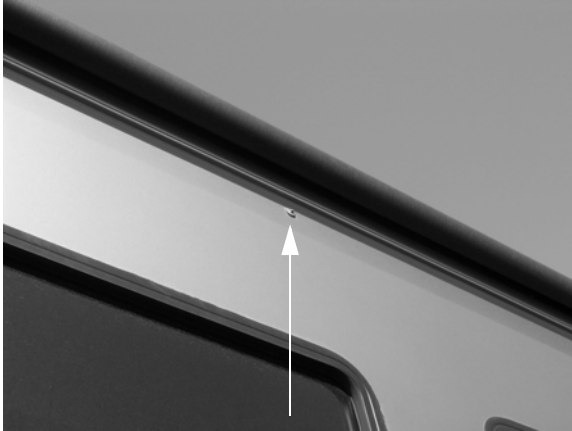

Slideout Lock Drain Line
(Located near the top of the
exterior slideout room)



SLIDEOUT ROOM KEYLOCK

A master Keylock slideroom switch is located near the power switch for the front slideout room. This keylock must be turned on to provide power to the slideout control switches.



Slideout Room Keylock

SLIDEOUT ROOM RETRACTION (WITH POWER LIFT BED OPTION)

-If Equipped

Your coach may be equipped with a power lift/lower mechanism that raises and lowers the head of your bed to best suit your comfort needs.

This power lift/lower mechanism is equipped with an interlock feature, which will not allow you to retract the bedroom slideout unless the bed is in the fully upright position.

NOTICE

Bed must be in the fully upright (vertical) position to fully retract slideroom.

Further Information

For further power bed operating instructions, refer to *Section 9 - Furniture and Softgoods* in this manual.

SLIDEOUT ROOM OPERATION – HYDRAULIC



WARNING

Your motor home may have more than one slideout room. Understand which switch operates which slideout room prior to operation. Make sure all slideout rooms are clear of people who could be harmed or obstacles that could cause damage prior to operating any slideout rooms. Failure to observe can result in death or serious injury.

The slideout room extends and retracts by a hydraulic mechanism with an electronic control system.

Front slideout room power and travel lock switches (if equipped) are located either on the dash, near the main entry door, or near the

Systems Monitor Panel. Location varies by model and floorplan.

Rear slideout switches (if equipped) are located on a wall in the rear of the coach in or near the slide room. Location varies by model and floorplan.



Slideout Switches

(Your coach may have one or more of these switches depending on model, options, and available equipment)
-Typical View

NOTE: Never drive the vehicle with a slideout room extended!

To Extend Slideout Room

WARNING

Keep all persons clear of the slideout room and moving parts while extending or retracting. Do not occupy the slideout room while it is being extended or retracted. Failure to observe can result in death or serious injury.

NOTICE

Check to be sure the exterior storage compartment doors below the slideout room extension are closed before extending or retracting the room to avoid possible damage to the doors.

NOTE: We recommend that you KEEP THE ENGINE RUNNING WHILE EXTENDING OR RETRACTING SLIDEOUT ROOMS so the engine

alternator can provide maximum power for proper operation of the slideout mechanisms.

Before Extending!

- Level the coach and set the Parking Brake. An interlock relay system will then provide power to the slideout control switches.
- Release the Slideout Locks (if equipped). *See information at the beginning of this section.*
- Make sure exterior compartment doors are closed so that they will not interfere with slideout operation.
- Check inside and outside the vehicle to make sure that there are no people who could be harmed or obstacles that could cause damage due to room extension.
- If the slideout room has a couch or other furniture, make sure no people or pets are seated on them until the room has been fully extended.

Extend Procedure:

See “Before Extending!” before proceeding.

- Start the engine so the alternator can provide maximum power for proper operation of slideout mechanisms.
- Be sure Parking Brake is set.
- Insert the Safety Lock key and turn to activate slideout room control switch.
- Press the Slideout Room “EXTEND/OUT” switch and hold until the room is fully extended, then release the switch.

NOTE: If your model is equipped with electric slideout locks and the room will not extend, check to be sure the locks are fully released. Press the “unlock” side of the switch for a few seconds, then try extending again.

NOTICE

Do not hold a slideout control switch in the “extend” or “retract” position for a time period longer than necessary to fully extend or retract the room. This can overheat and damage the pump or electrical motor as well as other electrical components.

- To stop extending the room anytime during operation, release the button.
- Deactivate the slideout switch with the Safety Lock key.

To Retract Slideout Room



WARNING

Keep all persons clear of the slideout room and moving parts while extending or retracting. Do not occupy the slideout room while it is being extended or retracted. Failure to observe can result in death or serious injury.

Before Retracting!

- Be sure the coach is level and the Parking Brake is set. An interlock relay system will then provide power to the slideout control switches.
- Check inside and outside the vehicle to make sure that there are no people who could be harmed or obstacles that could cause damage due to room retraction.
- If the slideout room has a couch or other furniture, make sure no people or pets are seated on them until the room has been fully retracted.
- Remove all items from the coach living room floor, close cabinet doors and drawers. Be sure there are no items at the end of the bed, behind

the driver seat, or protruding from compartments which could be crushed or cause damage to floor covering or cabinets when the room is retracted.

NOTICE

Because the slideout roof is drawn into the interior of the coach when retracted, be sure there is no debris, such as excessive dirt, tree seeds, twigs, leaves, etc. on the roof before retracting.

If it has rained recently before you retract the slideout room, we recommend using the hydraulic leveling system (if equipped) to lean the coach and drain off any excess water possibly remaining on the roof before retracting. Lean the coach slightly to the left (driver’s side) as shown by raising both right side jacks to let excess water flow away from the rooftop weather seal and toward the outside of the slideout roof. Retract the slideout slowly, starting and stopping to allow water to drain off room cover.

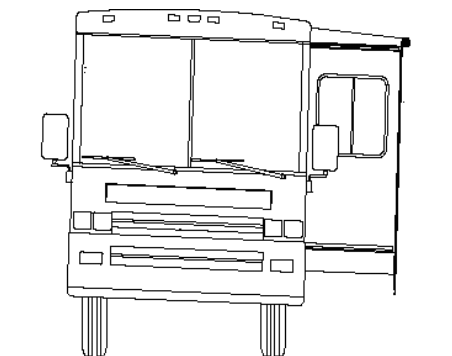

Retract Procedure:

See “Before Retracting!” before proceeding.

- Start the engine so the alternator can provide maximum power for proper operation of slideout mechanisms.
- Be sure Parking Brake is set.
- Insert the Safety Lock key and turn to activate slideout room control switch.

- Press the Slideout Room “RETRACT/IN” switch and hold until the room is fully retracted, then release the switch.

NOTE: If your model is equipped with electric slideout locks and the room will not retract, check to be sure the locks are fully released. Press the “unlock” side of the switch for a few seconds, then try retracting again.

NOTICE

Do not hold a slideout control switch in the “extend” or “retract” position for a time period longer than necessary to fully extend or retract the room. This can overheat and damage the pump or electrical motor as well as other electrical components.

- To stop retracting the room anytime during operation, release the button.
- After the room is fully retracted, deactivate the slideout switch with the Safety Lock key, then engage Slideout Locks (if equipped). *See information at the beginning of this section.*

NOTE: Visually confirm that the slideout lock has engaged by observing the room from outside of the coach and noting whether the top of the room is being held tightly against the sidewall of the coach.

SLIDEOUT ROOM – EXTREME WEATHER PRECAUTION

Certain extreme weather conditions, such as heavy rains, heavy snow, and high winds, or any combination of these, could cause damage to the slideout room cover-awning (if equipped) or reduce effectiveness of the slideout room weather seals.



Slideout Cover-Awning
-Typical View

Also, freezing rain and snow can prevent the slideout cover-awning (if equipped) from closing and may cause damage to the cover-awning, slideout room, weather seals, and mechanisms.

To avoid potential damage, we recommend retracting your slideout room during extreme weather conditions.

SLIDEOUT ROOM TROUBLESHOOTING – HYDRAULIC

If Slideout Room Will Not Operate

- The chassis battery may be low on charge. The engine should be running while extending or retracting slideout rooms so the engine alternator can provide maximum power to properly operate the slideout mechanisms. If battery charge is sufficient, go to next step.
- A fuse may be blown in the hydraulic system control box on the pump, which can be viewed from beneath the chassis near the left or right front wheel. See following illustration.



WARNING

Stop engine, place transmission in neutral position, and apply parking brake before lying beneath vehicle for this procedure. Failure to observe can result in death or serious injury.

See the Leveling System/Room Extension

Operator's Manual in your InfoCase for control box fuse replacement information. If no fuses are blown, go to the next step.

- If the batteries and fuses are okay, there may be a failure in the hydraulic control system or electrical system, which requires service. Retract the room using the following emergency retract procedures and contact your dealer for service.



Hydraulic System Control Box
(Located on pump beneath chassis
near LH or RH front tire)

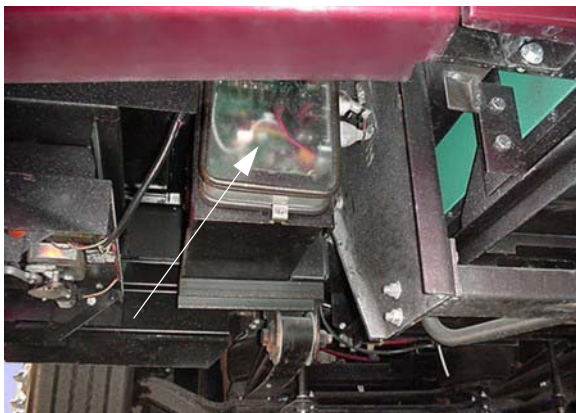

SLIDEOUT EMERGENCY RETRACTION PROCEDURES

Front Slideout Rooms - Emergency Crank-In Procedure

(If slideout room will not retract using
control switch)

Step 1: Relieve Hydraulic Line Pressure

- Open the hydraulic pump slideout solenoid valves to release hydraulic line pressure and let fluid bypass into the fluid reservoir.

NOTE: The hydraulic pump is located beneath the entrance steps. To access the pump, lift up the step cover and remove the storage bin.



Entry Step Storage
(Lift removable storage bin out to
access hydraulic pump)

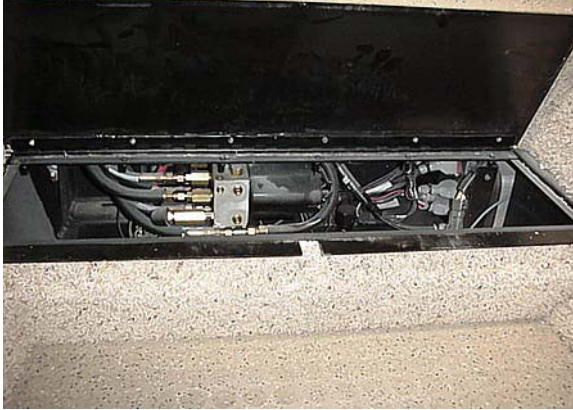

Hydraulic Pump
(Shown with storage bin removed)

- The hydraulic pump is equipped with two sets of hydraulic solenoid valves that control different systems.
The **large** solenoid valves control the **leveling jacks**.
The **small** valves control the **slideout rooms**.

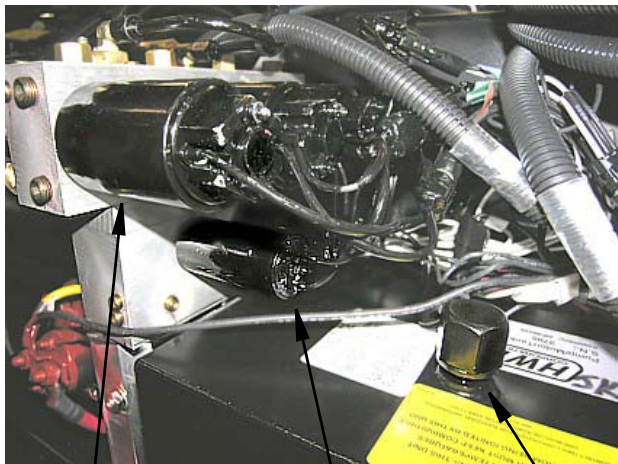

Leveling Jack Valves (Larger) Slideout Room Valves (Smaller) Hydraulic Oil Fill Cap

Leveling/Slideout System Hydraulic Pump
(Note valve positions in relation to fluid reservoir)

- The solenoid valves are opened by turning a small 1/4" **nut** at the end of each valve shaft. Pry out the protective plastic cap to access the nut. (Replace cap after servicing.)

Use provided 1/4" nut driver to turn nut counterclockwise 4 turns only.

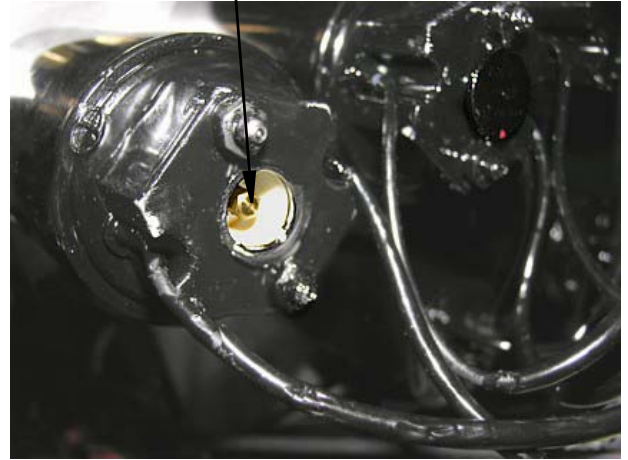

Hydraulic Pump Solenoid Valve

- Use the 1/4" nut driver built into the the end of the shaft of the oil reservoir breather/fill cap as shown.



Use 1/4" nut driver built into end of dipstick on pump reservoir cap to open slideout solenoid valves.

- Open the slideout solenoid valves 3-4 turns to relieve hydraulic line pressure.
See the Leveling System/Room Extension Operator's Manual in your InfoCase for specific instructions on which valves to open for front or rear slideout rooms and what additional precautions to follow.

⚠ CAUTION

DO NOT LOOSEN THE NUTS MORE THAN 4 FULL TURNS.
The valve shaft could come out, requiring valve repair or replacement.

- Do not open any of the large solenoid valves. These control the coach leveling jacks.

Step 2: Crank the Room Inward

- A wrench is used to crank the room inward. You may use the ratchet wrench supplied with the coach (in your InfoCase or one of the storage compartments) or any type of wrench of the same nut size.
- Crank-in bolts are located on the outboard mounting plates of the slideout room as shown. These plates are located at both ends of the room inside the compartment doors.
- Loosen the locking screws below the crank-in bolts as shown before trying to turn the bolts.

Loosen Stop Bolt



Turn Retract Bolt to crank room in

- After loosening the lock screws, fit the ratchet wrench onto the bolt head and begin cranking clockwise slowly a few turns, then alternate to the other side for a few turns.

You can speed up the process with the help of an assistant using an additional wrench to crank both sides evenly together.



Crank the Slideout Retract Bolt with the Ratchet Wrench provided.

- Crank the wrench(es) clockwise slowly, until the room is fully retracted. Allow about 10 minutes to crank room in fully.

NOTE: Attempting to crank the room in too quickly will raise pressure in the hydraulic fluid lines and make cranking more difficult.

⚠ CAUTION

The retract bolts must be 'backed out' to their original positions immediately after the crank-in procedure to avoid damaging the retract bolts and slideout mechanism the next time the room is extended.

Step 3: Secure Travel Locks and Close Hydraulic Line Valves

- Activate the slideout room travel locks.
- Close the slideout solenoid valves completely.

NOTE: Close the valves snugly, but do not overtighten. Overtightening may cause internal damage to the valves.

- See your dealer for service of the room extension system before using again.

Bedroom Slideout Rooms - Emergency Push-In Procedure

In the unlikely event that your bedroom slideout fails to retract using the power switch, check for obvious causes first, such as low charge on the chassis batteries, or a burned out fuse on the hydraulic system control box. (See “Slideout Room Troubleshooting” elsewhere in this section.)

‘Push-In’ Procedure

- Open the slideout room solenoid valves on the pump to relieve hydraulic line pressure. (See “Step 1: Relieve Hydraulic Line Pressure” and photos on previous pages.)
- **DO NOT OPEN THE LEVELING JACK VALVES.**
- Apply a steady inward pressure of approximately 150 lbs. to the exterior sidewall of the slideout room to push the room in toward the coach until it is snug against the main coach sidewall.

NOTE: Use some type of rigid, padded material to protect the sidewall from punctures, dents or other damage to the finish from any device or equipment used to press the sidewall in.

- Pressure must be applied evenly to avoid binding of the hydraulic mechanism. It may take about 10 minutes to press the room extension inward completely.
- When the room is snug against the coach wall, close the solenoid valves to prevent “creep out” during transit.

See your Authorized Winnebago Industries® Dealer for service of the slideout system before using again.

NOTE: When the system has been corrected, check hydraulic fluid level and refill reservoir as necessary. Press the Retract switch for 15 to 20 seconds before attempting to extend the room. Then run the room out and in several times to purge any air from the hydraulic system. Finally, recheck fluid level and fill as necessary.

Further Information

See the Hydraulic Leveling System/Room Extension Operator’s Manual in your InfoCase for further instructions and troubleshooting information.

GENERAL SLIDEOUT CARE

- Wipe outer seals occasionally with talc or 303 brand protectant for smooth quiet operation.
- Clean the floors inside before retracting the room to avoid vinyl flooring scratches or carpet pile snags.
- See your authorized dealer for regular maintenance and service of the slideout mechanism.



WARNING

Never check for hydraulic fluid leaks using your hands and/or any other body part. The leaking fluid is under pressure and is capable of cutting and penetrating your skin, resulting in severe injury.

LEVELING SYSTEM

The leveling system makes selecting a parking site easier and faster by reducing the effect of uneven ground.

Hydraulic jacks raise the affected low corners of the coach to make leveling “set up” faster and easier for you.

The leveling system control panel is located in the dash area.

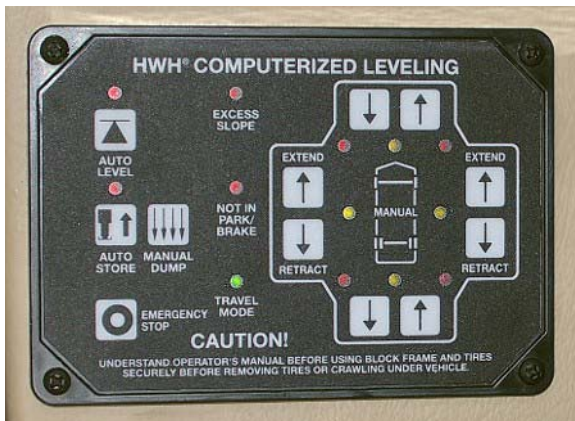

Leveling System Control Panel

See the **Leveling System Operator Manual** in your **InfoCase** for complete operating instructions. It also contains additional precautions, technical information, and instructions for manual operation if a system failure occurs.

NOTE: When parking at an uneven site, always park the front of the motor home to the downhill side. This allows you to level by raising the front end rather than the rear. Since only the rear wheels are locked while in PARK, raising either one or both of the rear wheels off the ground could allow the vehicle to roll off the jacks.



WARNING

- Keep all people clear of the coach while the leveling system is operating.
- When extending the rear stabilizers, do not lift the wheels beyond ground contact. This makes it possible for the vehicle to roll unexpectedly forward (or backward) off the jacks. This could cause severe injury or death.
- Do not use the levelers on icy or slick surfaces on which the foot pads may slip.
- Do not use leveling jacks to support the vehicle for service or tire changing.
- Do not use the leveler as an emergency brake. They are not designed for any type of vehicle braking purpose.
- Never check for hydraulic fluid leaks using your hands and/or any other body part. The leaking fluid is under pressure and is capable of cutting and penetrating your skin, resulting in severe injury.

Auto Level Remote Switches –If Equipped

In addition to the dash control panel, your coach may be equipped with two remote switches for your leveling convenience.

These switches allow you to extend or retract your jacks and observe them at the same time. It also allows you to stop them suddenly, if needed, without having to climb in and out of the coach.

The remote switches are located just inside the entrance door and in the service center.



Auto Level Switch
(Located inside entrance door)
-Typical View



Auto Level Switch
(Located in service center compartment)
-Typical View

Jacks Down Light

The “Jacks Down” reminder is intended to warn you to retract your leveling jacks before moving the vehicle. The light will come on briefly and a chime will sound when the ignition key is turned to the On or Run positions if the jacks are down.



“Jacks Down” Light
(Located on dash)
-Typical View

NOTICE

- Do not try to drive vehicle unless “TRAVEL” light is glowing with ignition switch on.
- Do not try to drive the vehicle until the air suspension system has built up sufficient pressure if you have used the coach leveling system or have used the DUMP button to manually exhaust the air suspension system.
- Do not rely only upon the warning lights to indicate when jacks are up. It is the owner’s responsibility to check that all jacks are up before moving the coach.

NOTE: If the leveling jacks should fail to retract, see the MANUAL JACK RETRACTION section of the Leveling System Operator’s Manual included in your InfoCase.

In The Event Of Accidental Jack Extension

1. Bring the vehicle to a safe and complete stop as soon as possible.
2. Turn the leveling systems power switch on and press the “Auto Store” switch.
3. Visually inspect the vehicle undercarriage for any problems.

4. See the Leveling System Operator's Manual supplied in your InfoCase for troubleshooting instructions or operating the leveling system if jacks fail to retract or any other functions fail.

CHECKING HYDRAULIC OIL LEVEL

See the Leveling System Operator's Manual in your InfoCase for complete maintenance instructions and information.

All maintenance should be done as part of the normal servicing of the coach.

The hydraulic oil level should be checked when the vehicle is first purchased, and then twice a year - or more often if an oil leak develops in the system.

The hydraulic pump is located under the entrance step. Lift up step cover and remove storage bin (if equipped) to access.

Jacks and Slideout Positions

To get an accurate indication of oil level:

- Leveling Jacks must be UP
- Slideout Rooms must be IN

Checking Dipstick

The hydraulic oil level is checked with a dipstick built into the breather/filler cap on top of the oil reservoir, which is part of the hydraulic pump/manifold assembly.

NOTE: Always clean away any dirt and debris from the top of the reservoir before removing the breather cap to avoid entry of debris and contamination of hydraulic oil in the reservoir, which could lead to pump failure or other problems.

The oil level should be between the two marks on the breather cap dipstick shown in the following photo.

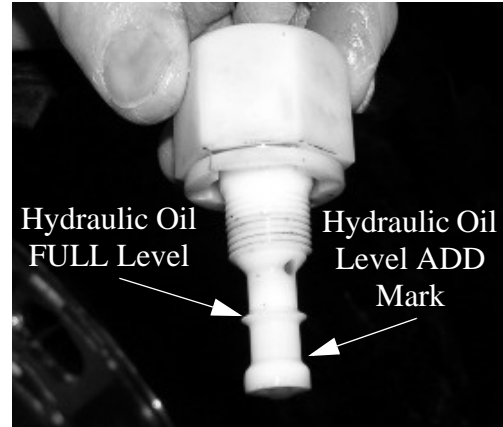

Hydraulic Oil Breather Cap/Dipstick
-Typical View

NOTE: Overfilling the hydraulic reservoir can cause leakage of oil through the breather cap.

Hydraulic Fluid Recommendation

HWH[®] specialty hydraulic fluid or Dexron[®] III automatic transmission fluid is recommended for use in this system.

DO NOT USE brake fluid or hydraulic jack oil, which can damage the seals and cause leaks.

TOUR

SECTION 11 – MAINTENANCE AND STORAGE

SEALANTS – INSPECTION AND GENERAL INFORMATION

Water is a recreational vehicle's worst enemy when it is allowed to enter where it is not intended. Sealants perform a very important function and should be inspected closely and maintained regularly. Winnebago Industries® utilizes many different types of sealants. Refer to the "Sealants Call-Out Sheet" provided in your InfoCase for further information.

Sealants, in general, do not have "set" lifetimes. Varying environmental factors affect the pliability and adhesiveness of sealants. You or your dealer must:

- Inspect all sealants, a minimum of every six months.
- Inspect the moldings, windows, clearance lights, exterior compartment doors, and all their attachments.
- Also, inspect weather seals around entrance door, etc., and if necessary, have a dealer replace them immediately.
- Check for cracks, voids, gaps, breaks, adhesion, and any sign of physical deterioration.

NOTE: Proper sealant inspection includes not just visual observation but running a finger along sealant seams to verify proper adhesion to the surface. Any loosened areas must be replaced.

- Have the sealant replaced if you notice any of the above. Your local Winnebago Industries dealer has the correct and necessary parts and experience to help you maintain your sealants. See "Sealants Call-Out Sheet" provided in your InfoCase.
- Always use the same type sealant that was removed.
- Immediately have dealership check moldings, windows, and exterior attachments for leak source if you notice water inside of unit.

NOTICE

Sealants must be inspected every 6 months and replaced if necessary.

ROOF



WARNING

Stay off roof. Roof surface may be slippery. Falling could result in death or serious injury.

The roof is made of Thermo-Panel materials like the walls and floor. It will support the weight of an average adult for periodic maintenance or repair of the roof or roof mounted components.

Walking or working on the roof should be left to qualified service personnel using proper safety equipment in a safe environment. You should only walk or work on the roof if you are qualified and have created a safe environment.

For your safety, it is not recommended that you store or carry items on the roof.

Always have damage to the roof area repaired immediately. Damaged or detached sealant around the vents, air conditioner, body-to-roof seams, etc., should also receive immediate attention. Delaying these repairs may allow water leakage and result in damage to interior ceiling and body panels, upholstery, etc., which is not covered by the limited warranty (see Introduction section).

UNDERCARRIAGE

Buildup of mud and dirt under the body of the coach can cause damaging rust or corrosion on steel or aluminum parts and can add needless

weight to the vehicle. This, in effect, reduces the amount of cargo you can carry and remain within GVWR and GAWR limits.

Corrosive materials, such as those used for ice and snow removal and dust control, can also accumulate on the underside of a vehicle. These materials should be removed by flushing the undercarriage regularly with water, especially horizontal surfaces, cavities, and other areas where mud and other deposits may collect.

EXTERIOR AUTOMOTIVE PAINT FINISH

–If Equipped

The body of your coach is fully or partially finished with the highest quality automotive paint and clearcoat. Follow these precautions to keep the finish on your coach looking its best and preserve maximum gloss and durability.

Parking

- **Avoid parking under trees** – When this happens you should rinse the bird droppings and tree sap off as soon as possible. Tree sap is a form of sugar and will dissolve after a couple of rinses. Bird droppings can eat into a painted surface if left unattended and need removed as soon as possible. Lukewarm soapy water can help speed up the cleaning process.
- **Avoid parking near salt spray** – When this happens you need to rinse off the salt mineral residue to minimize the corrosiveness of the salt.
- **Avoid parking near factories with heavy smoke or industrial fallout** – Industrial fallout can eat into your coaches finish when dew or rain mixes with it to create nitric or sulfuric acid that gets magnified by the intensity of the sun. As the water evaporates the acid becomes more powerful and attacks the painted surface. Rinsing and washing the surface helps remove the fallout and neutralize the acid. After the

initial 60-day cure stage, a coat of wax or polish can help protect the surface from these types of contaminants.

- **Do not scrape ice or snow from the painted surface.** Brush off gently with a soft-bristled ‘snow brush’ – avoid being forceful with the brush. If brush scratches show after the motorhome thaws out, it may be possible to remove them by hand waxing with a silicone-free liquid wax.

Driving

- Avoid driving on gravel roads.
- Rinse off bugs and bird droppings with water daily.
- Antifreeze, fuel or windshield/window solutions spilled on the painted surface should be rinsed off immediately with water and allowed to air dry. Wiping dry with a towel may create fine scratches due to the solvent nature of these types of fluids.
- Fuel cannot be diluted and dissipated with water. It must be removed with a mineral spirit type cleaner (such as *SEAFOAM Bugs-B-Gone* or equivalent) or a silicone-free spray wax and microfiber cloth to remove the stain left by fuels.

NOTE: When driving in wintry conditions the road surface may be covered with heavy salts or small rocks to improve road traction. These types of road conditions can cause undue surface damage to your RV. Please refrain from driving in these conditions

Washing

- Commercial vehicle wash facilities should be strictly avoided! They will scratch your RV!
This is because truck style wash centers have high-pressure wands that emit higher than necessary water pressures and the brushes are very aggressive. Most truck wash brushes are made from a heavy plastic for durability and are under heavy pressure. They are designed

to clean heavy road films on semi trailers and are often dirty. They are not designed for custom painted RV's and they will scratch the clearcoat finish. Many times these scratches can penetrate the clearcoat finish causing delamination and/or other paint related issues that are not covered under warranty.

- Wash your RV with cool or lukewarm water using a mild soap— such as a baby shampoo— that does not contain bleach solution. Most auto stores offer car wash detailing soaps that are similar and do not have bleach in the formulation (*such as Meguiars #62*).
- Never use a bristled brush or broom to wash the painted surface. This will cause scratches in the finish. Use a clean lamb's wool mitt, sponge or microfiber mitt (or mop) to wash your unit.
- Be sure your cloth or applicator is clean. A dirty applicator can scratch your RV.

Washing Procedure

- Rinse area to be washed with cold water to remove surface residue. Make sure you are not in direct sunlight.
- With area to be washed still wet from the rinse, use the recommended soapy mixture to clean the area. Use care to make sure that a clean lambs wool mitt, sponge or Microfiber mitt or mop is used to apply soapy water.
- Rinse washed area before soap evaporates.
- Dry the rinsed area before the water evaporates.

NOTE: Avoid aiming water flow from a hose or spray from high pressure washing equipment into any appliance intake because damage or difficulty in operating appliances may occur.

- After washing the coach, carefully inspect sealant around window frames and vents and any other joints that may have loosened or separated. See “Sealants” at the beginning of this section for details.

Bug Removal

- Rinse the loose debris off with water and allow the remaining residues to soak and soften. Use soap and water to wash the residue, then rinse. (You may wish to repeat and leave soap on longer than normal to help with softening hardened residue.)
- For more stubborn areas use an ammonia based glass cleaner followed by a warm soapy water wash and a rinse.
- Remember to use micro-fiber towels during this process to help avoid scratches.
- If this does not work, as a last resort, use a bug removal product (*like SEAFOAM Bugs-B-Gone or equivalent*) in a shady area and follow the directions on label.

Polishing and/or Waxing

NOTE: When your coach is new or has been repainted for any reason, no polish or wax should be applied to the finish until after a 60-day cure cycle at temperatures higher than 60 degrees for 60 days. Failure to observe this precaution could void your paint warranty.

- We recommend a silicone-free polish (*such as Meguiars M8132 Hand Polish or Machine Polish*) with an orbital machine and terry cloth applicator.
- Liquid waxes are easier to apply and bring to a gloss with fewer residues.
- Avoid paste waxes. They sometimes have fillers and additives that give a very short term result. Stay away from silicones in polishes and soaps.
- Buffing Compounds remove some of the mil film of the clearcoat, so we recommend that only professionals or very experienced users apply this type of product.

Inspection

A motorhome exterior is subjected to many physical forces and environmental conditions. While the coach is parked, it is exposed to climate and weather extremes and other environmental conditions. While in operation, it

is subjected to various twisting and flexing forces caused by routine cornering and turning, and by uneven road surfaces, such as bumps, potholes, railroad tracks and parking lot entrances.

Inspect the exterior fiberglass shell periodically for cracks which may represent a threat to the integrity of the fiberglass.

Minute cracks in the surface, commonly called "spider cracks" or "hairline cracks" caused by normal flexing of the fiberglass exterior are normal and typically pose no threat to the integrity of the vehicle other than appearance.

However, if a crack has opened up and the weave of the cloth is visible, this does represent a threat to the integrity of the fiberglass and must be repaired or covered as quickly as possible to avoid penetration by moisture, especially in freezing climates.

If the fiberglass has been damaged and contains cracks, tears or holes, use plastic sheeting and duct tape, if necessary, to prevent moisture from damaging the sidewall material or the interior of the coach.

CARE OF APPLIQUES AND DECALS

The pressure-sensitive appliques and decals on your coach require very little maintenance. They should be treated like any painted surface on your vehicle.

Here are a few helpful hints on caring for decals:

- Wash appliques and decals with plain soap and water or any retail car wash soap. Always rinse thoroughly.
- **High pressure water spray may loosen or damage appliques and decals.**
- Test any cleaning solution on a small section of appliques or decal before using.
- Never use aromatic solvents such as acetone, MEK, toluene, xylene, lacquer thinner, etc., on appliques or decals. Any solvent including alcohol may soften or smear colors.

- Fuel or antifreeze spilled on appliques or decals should be rinsed off immediately with water.

FRONT END MASKS AND PAINT DAMAGE

NOTE: This information is to make you aware of a potential paint failure that could occur when moisture is trapped between front end masks and painted surfaces.

If you choose to install an aftermarket protective front end mask, please follow these preventive guidelines:

- The front end mask must be removed if the vehicle sits longer than 5 days without being driven.
- The front end mask must be thoroughly dry before storing away or reinstalling on the front of the coach.
- When reinstalling the mask, be sure both the mask and the painted surface are free of debris to avoid damage by abrasion.
- Failure to follow recommendations will void any paint warranty.

HEADLIGHTS AND EXTERIOR LIGHTS

Exterior Light Lenses

Most Winnebago Industries® vehicles have polycarbonate lenses on exterior lamps, which are very sensitive to a variety of chemical solvents and cleaners.

Use only soap and water to clean exterior lamp lenses - especially headlights.

- Contact with certain chemicals can cause etching, "crazing", or cracking of the lens, which can significantly reduce the lens clarity and effectiveness of the lamp and may require replacement of the complete lamp housing.
- Some popular citric acid cleaners may cause bicarbonate lenses to become "hazy" or "foggy".

- Do not use a pressure washer to clean headlights.
- Inspect and operate the lights regularly to confirm proper operation and mounting condition.

Headlight Moisture

Your coach is equipped with composite headlights, which contain replaceable halogen “bulb” elements, common to most current automobiles. This type of lamp assembly is not sealed from the atmosphere and is designed with a moisture venting system.

Because they are not sealed, under “dew point” conditions the headlights may exhibit signs of humidity condensation on the reflector surface and lens, such as small droplets of water or “fogging over”.

If this happens, drive with the headlights on so the moisture can evaporate and expel through the venting system designed into the headlamp assembly.

PLASTIC PARTS – CLEANING

Many parts in your motorhome, such as the dash, exterior light lenses, and certain exterior body panels are made of high-impact plastic materials that can be damaged by wiping with solvents or improper cleaning products.

Always try cleaning plastic parts with the mildest cleaners first and work your way up to stronger cleaning products. Use the following cautionary lists as a guide when selecting cleaning products to use on plastic parts.

NOTICE

Do not use citrus-based cleaners on polycarbonate finishes. Citric compounds will damage the high-gloss surface, causing it to appear dull or “flat”. Always test a cleaning product on a hidden area to be sure it will not cause damage to the appearance of the part.

Here is a list of mild cleaners that **may be used safely**:

- Car washing soap and water
- Glass cleaners *without ammonia*
- Mineral oil
- Multipurpose cleaners (such as Fantastik[®], Formula 409[®], etc.)

The following products, compounds, or solvents must be **wiped off immediately** to avoid damage:

- Ammonia
- Brake fluid
- Bathroom basin, tub, and tile cleaners
- Chlorine
- Ethyl alcohol
- Isopropyl (rubbing) alcohol
- Kerosene or gasoline
- Naphthalene
- Pine-type household cleaners

Do not use cleaners containing the following products, compounds, or solvents. These products **will damage** the finish.

- Acetic acid
- Acetone (nail polish remover)
- Aromatic solvents (lacquer thinners)
- Benzene
- Butyl alcohol

INTERIOR SOFT GOODS

We recommend a weekly routine of vacuuming all fabrics and carpet throughout the motor home to prevent an accumulation of dirt, which can detract from the appearance and shorten the life of carpet and fabrics.

Fabric Upholstery

Some fabrics used in this motor home may contain fire retardant and lightfastness additives, which can be damaged by use of improper cleaning products. Some water-based household cleaning products are not formulated for use on fabrics and may cause excessive shrinkage or fading. Always test any cleaning product on a

SECTION 11 – MAINTENANCE AND STORAGE

TOUR

hidden area of fabric before using on visible areas. For best results, fabric cleaning should be referred to a professional carpet and upholstery cleaner.

NOTE: To minimize fading of upholstery, carpets and other interior fabrics caused by excessive sunlight, the drapes, blinds, or shades should be closed when the motor home is parked for an extended period of time.

WARNING

When cleaning upholstery and fabric, do not use lacquer thinner, nail polish remover, laundry soaps, or bleach. Never use carbon tetrachloride, gasoline, or naphthalene for any cleaning purpose. These materials may cause damage to the material being cleaned and most are highly flammable, posing risk of injury due to fire.

- Air dry or, if desired, dry quickly using a hair dryer on warm setting - not hot.
- For stubborn stains, use cleaner-degreaser.

UltraLeather Cleaning Chart		
Type of Stain	Detergent/ Water	Cleaner/ Degreaser
Coffee, Tea	◆	
Red Wine, Liquor	◆	
Cola, Soft Drinks	◆	
Milk	◆	
Ketchup	◆	
Steak/Soy Sauce	◆	
Mayonnaise, Butter	◆	◆
Salad Oil	◆	◆
Chocolate	◆	◆
Cosmetic Makeup	◆	◆
Lipstick	◆	◆
Face Cream	◆	◆
Suntan Oil/Lotion	◆	◆
Shoe Polish	◆	◆
Urine	◆	◆
Machine Oil		◆

UltraLeather™ Leather-Like Upholstery –If Equipped

UltraLeather synthetic leather fabric material has the luxurious look and feel of the finest European calfskin, with the durability and resistance to soils and stains of vinyl fabrics. It is also tougher than real calfskin and has superior resistance to punctures, snags, and rips.

For most soils and stains, the fabric manufacturer recommends spot treatment with a solution of water and Tide® brand laundry detergent or equivalent. More stubborn stains may be treated with a water-based multipurpose cleaner/degreaser such as Simple Green® or equivalent. Solvent cleaners such as nail polish remover or other aromatic solvents are not recommended.

Care Instructions

- Spot clean with mild soap and water.

Vinyl Fabrics (including ceiling) –If Equipped

Vinyl should be cleaned with a soft, damp cloth, and a mild detergent only. Do not use solvents. Solvents may damage the surface of the vinyl.

Draperies, Curtains and Bedspreads

These items may be woven from a variety of fabrics. We recommend that these be professionally dry cleaned only. A five percent shrinkage may occur when you have these items dry cleaned.

CABINETRY – CLEANING

Wooden items may be cleaned with a soft cloth and a good quality wood finish cleaning product.

Vinyl simulated wood panels may be cleaned with a mild, water-based cleaner and a soft cloth. Do not use solvents on vinyl wood panels.

NOTE: Many cabinetry and furniture items throughout this motor home are constructed either partially or completely of real hardwoods. Because of natural variations in woodgrain density, slight differences in stain hue may exist between one item and another. This is the distinctive character and beauty of real wood.

SOLID SURFACE COUNTERTOP – CORIAN®

Care and Maintenance

You can easily maintain the beauty of your countertop with little effort, under most circumstances, using a window spray cleaner, warm soapy water, or other general purpose spray cleaner. You can also use liquid or gel-type cleaners containing bleach. Because the material is nonporous, stains cannot penetrate below the surface and will nearly always disappear using these cleaning methods.

If a stain has dried on, allow the cleaner or soapy water time to soften the area, after which the stain will wipe off.

If the stain is not water-base or oil-base material, you may need to gently remove it using a plastic scraper (disposable plastic knife for example) followed by normal cleaning methods described above.

You may want to scrub the entire surface periodically. Do this lightly and evenly with a mild abrasive powdered or liquid cleaner.

Always use a cutting board rather than slicing foods directly on your countertop. The underside of one of your sink covers will provide an easily accessible cutting surface. This will keep your countertop looking its best and minimize care efforts. (An occasionally sanding with a medium grade (120 grit) sandpaper will remove any cut marks accumulated on the sink cover bottom).

To remove cuts and scratches, use a more aggressive cleaning powder such as Comet®, a moistened steel wool soap pad, or green scouring pad. We recommend that you finish the entire surface using the same cleaning material and scrubbing method to maintain a uniform appearance.

If you prefer a glossier look, follow up with a good quality furniture polish or a liquid automotive wax (non-cleaner type).

Use trivets and “hot pads” under hot cooking pans. Do not set hot pots or pans directly from the stove or oven onto the counter. The solid surface material is extremely heat resistant, but sudden contact by a very hot material with a cold countertop surface could cause a crack that would need to be repaired. Likewise, concentrated high heat sources in a small area, such as a crock pot or an electric griddle may cause a crack. We strongly recommend using a trivet under these. Also do not allow candles to burn directly on the counter surface.

Avoid paint remover or oven cleaner. The solid surface material is also resistant to most chemical substances but exposure to some harsh chemicals and solvents such as these can cause damage that would need professional repair or replacement. If one of these materials does spill or drip onto the counter surface, wipe it up immediately to avoid damage.

GALLEY SINK

Stainless Steel

Care and Cleaning Instructions

The stainless steel sink can usually be cleaned with water and soap or detergent using a soft cloth or sponge.

- **Rinse thoroughly** with warm water and wipe dry quickly to avoid spots and streaks.
- **For stubborn stains**, use a mild abrasive cleanser like Soft Scrub®, Comet®, etc. Work in the direction of the “grain” of the brushed finish lines.

- **Never use steel wool.** Particles of steel from the wool pad can embed into the sink surface, then become rusty and unsightly.
- **Avoid contact with full-strength** bleaches, household chemicals, and acid-based cleaners. If this happens, rinse and wipe dry quickly.
- **Salt, mustard, and mayonnaise** can cause pitting if left on the steel sink surface. If spilled, clean and rinse immediately.
- **A high iron content** in the water (hard water) may result in a brown or rust-colored stained appearance. If noticed, dry towel sink after each use.
- **Do not use rubber mats** in the sink bowl. Material trapped under mats can complicate cleaning.

NOTE: Improper use may damage this product and void the warranty.

RANGE AND REFRIGERATOR

For care and appearance maintenance of the range and refrigerator, refer to the appliance manufacturer's operation and maintenance manuals included in your InfoCase.

BATHROOM

Toilet

For instructions on the care of your toilet, refer to the information in your InfoCase.

Tub and Shower Walls

The tub and shower walls in the bathroom should be cleaned with mild soap and warm water. Do not use an abrasive cleaner on the shower walls and tub, as scratching and discoloration may occur. Stubborn stains may be removed with an automotive-type cleanser.

Lavatory Sink

Do not use abrasive cleaners, harsh detergents, or solvents.

General Cleaning. Rinse all food, beverage, or cosmetic residue from the sink as soon as possible. Some residues, if left to sit in the sink, may require the use of detergent or a mild liquid or gel abrasive cleaner.

Hard-to-Remove Food and Beverage Residue. Use an abrasive cleanser such as Ajax[®], Comet[®], Bon Ami[®] or Bar Keeper's Friend[®] to remove mild stains and for routine cleaning. Use an abrasive pad such as Scotch-Brite[®] to remove most of the tougher stains.

For the most stubborn stains, fill the sink about one quarter full with a 50/50 solution of bleach and water. After 10 or 15 minutes of soaking, drain solution from the sink as you rinse both sides and bottom.

NOTE: Do not use steel wool or metal scouring pads.

Mineral-Based Stains. Cleaners designed to remove iron or rust should not harm the sink, nor will solvents such as denatured alcohol, mineral spirits, or acetone.

Marks or Discoloration. White automotive rubbing compound may be used to remove stubborn marks or discoloration. Use of these products will not damage the solid surface. Always follow label directions.

DOORS AND WINDOWS

Windows may be periodically cleaned with a good quality glass cleaner or mild soap solution using a soft cloth.

Use care when removing ice or frost from the windows. Always use a plastic ice scraper, never one made of metal. Use care when removing ice from the mirrors to protect the reflective surfaces.

Door locks and hinges should be lubricated periodically with powdered graphite to ensure trouble-free operation and to protect against freeze-up.

VEHICLE STORAGE – PREPARATION

Properly preparing your vehicle for storage will lessen the possibility of damage to your vehicle. Prepare the motor home for vacancy just as you would if you were leaving your house for an extended period.

Clean and Prep Coach for Storage

1. Turn off the propane gas tank.
2. Turn the furnace thermostat switch OFF.
3. **Remove all foods and items that may cause odors from cabinets and refrigerator.**
4. Clean and defrost the refrigerator. Prop the door open slightly to allow any odors to dissipate. Place an open box of baking soda inside the refrigerator to help absorb odors.
5. **Fully charge the batteries. Batteries must have at least 80% charge to survive freezing temperatures and long period of non-use.** We recommend that you connect a battery charger or plug in the shoreline once a month during long-term storage periods to maintain battery charge and to avoid sulfating. If connecting a charger directly to batteries, turn the Aux/Coach Battery Switch off to avoid electrical arcing when attaching and detaching charge clamps.

NOTE: We do not recommend leaving the shoreline plugged in continuously during storage periods because the batteries can lose electrolytic fluids and become damaged from continuous charging without periodic use. We recommend following regular battery inspection and maintenance especially in cold weather. See “Battery Care” in the Electrical section.

6. After charging batteries, turn the Aux/Coach Battery and Chassis Battery Switch off to disconnect the batteries and avoid parasitic* drain.

** Parasitic battery drain is the gradual drain by items connected directly to battery power such as clocks, radio memory, and the*

engine computer.

7. Have the vehicle chassis completely serviced and lubricated. Be sure radiator antifreeze protection level is sufficient for the lowest anticipated temperatures.
8. Wash and wax the coach.
9. Inspect all seams and seals around doors, windows, vents, and any other joints. Replace or repair any that are damaged. Sealing materials and compounds can be purchased from your dealer. Badly damaged weather seals may need to be replaced by your dealer.
10. Close all windows and roof vents. Protect all appliance vent openings from contamination by animals or insects (e.g. bird nest, wasp nests, etc.)
11. Lubricate all door hinges and locks.
12. Clean the interior of the coach. Dirt and stains are more easily removed when fresh.

If you are storing your vehicle through the winter, or in cold climates, extra preparations must be made to protect equipment and systems that can be damaged by freezing temperatures. See *Winterizing Procedures* in Plumbing section.

VEHICLE STORAGE – REMOVAL

1. Completely air out the motor home.
2. Have the entire LP gas system checked for leaks.
3. Check window operation.
4. Check cabinet and door hinges. Lubricate with penetrating oil, if necessary.
5. Close all faucets and drain valves that are open.
6. Add a few gallons of water to the fresh water tank and turn on the water pump to check for leaks, especially at fittings.
7. Open all faucets in turn to release trapped air and check to be sure faucet washers have not hardened during storage.
8. Sanitize the water system as outlined under “Disinfecting the Fresh Water System” in *Section 7 - Plumbing*, then flush the waterlines thoroughly with fresh water.

9. After flushing fresh waterlines, install a new water filter cartridge on the galley sink water filter and/or full-coach water filtration system (if equipped). See appropriate filter installation instructions in *Section 7 - Plumbing*.

NOTE: Always purge a new filter with clean running water before using. See filter manufacturer's directions included with the filter cartridge.

10. Check the toilet for proper operation.
11. Add water to the holding tank using the toilet flush pedal (or the "Normal Flush" switch if your coach is equipped with an electric flush toilet) and galley sink faucet. Check to be sure dump valves seal tightly.
12. Check around all appliances for obstructions and ensure that all vent openings are clear.
13. Start refrigerator and check for proper cooling.
14. Clean wall and counter surfaces.
15. Replace batteries, if necessary, and check out electrical system to make sure all lights and electrical components operate.
16. Check tires for proper cold inflation pressure. See *Vehicle Certification Label* in Introduction section.
17. After washing accumulated winter grime from the vehicle, it is important to carefully inspect the seams and sealants for separation or cracks that may have appeared around the window frames, vents, and any other joints. See *Sealants – Inspection and General Information* at the beginning of this section. Re-sealing is quite simple and the material is quickly and easily applied. Appropriate compounds are available from your dealer. See *Sealants – Recommended Application* page in the Supplement Manual provided in your InfoCase.
Also inspect weather seals around doors, etc., and if necessary, have a dealer replace immediately.

Ice Maker Start-Up

–If Equipped

1. Close all drain valves.
2. Turn the water supply on.
3. Be sure the ice bin is in place and the automatic shutoff arm is down.
4. Let the refrigerator cool down to ice making temperature. Remember, this can take up to 24 hours.
5. Let the ice maker cycle and dump the first batch of ice.

CHASSIS SERVICE AND MAINTENANCE

Consult the appropriate sections in your chassis manual for specific information regarding operating safety, service recommendations, and maintenance schedules for the chassis section of your motor home.

CHASSIS FUSES AND RELAYS

-Freightliner® Chassis

Chassis and dash component fuses and relays are located in the 12-volt electrical compartment at the left front of the coach.

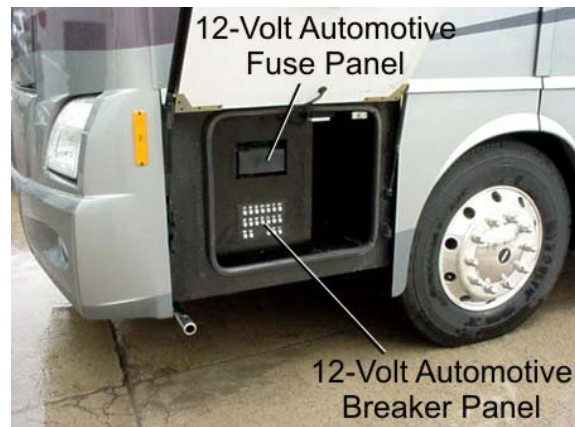

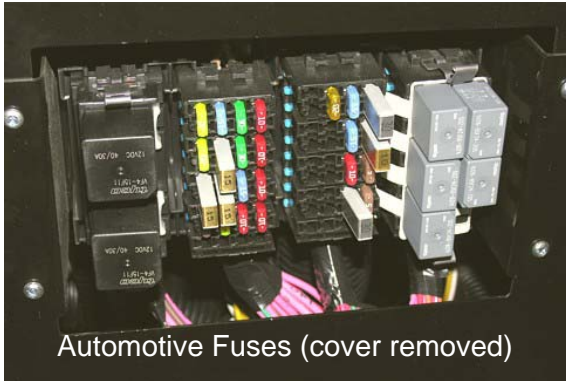

Automotive Fuses (cover removed)



Fuse Diagram (inside of cover)

See the chassis manufacturer's fuse allocation chart on the inside of the fuse block cover.

Towing Fuses

The fuses for the chassis supplied towing package are located inside the driver side rear compartment.

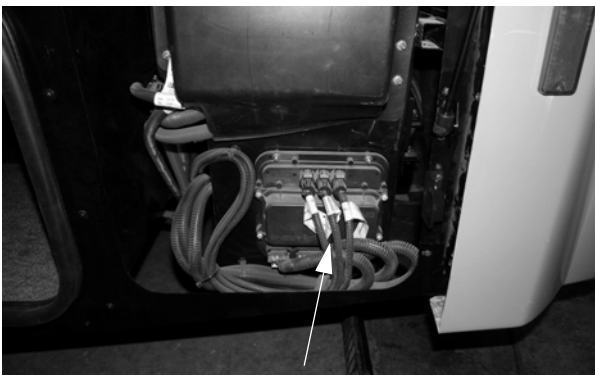

Towing Package Fuses
(Located in driver side rear compartment)
-Typical View

- See chassis manufacturer's information on inside of cover.

CHASSIS DIAGNOSTIC CONNECTORS

The chassis diagnostic connectors are located in on the steering column support plate beneath the dash and in the rear engine compartment as shown in the following photos.



Diagnostic Plug
(Located on steering column support plate beneath left side of dash)
-Typical View

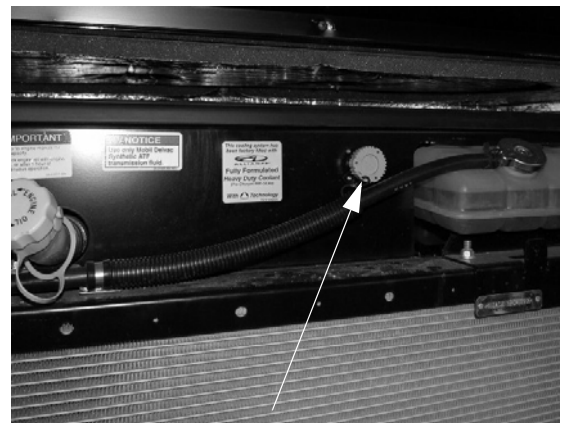

Diagnostic Plug
(Located on rear engine compartment shroud)
-Typical View

**SECTION 11 –
MAINTENANCE AND STORAGE**

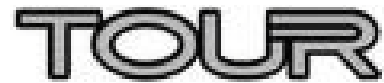

COACH MAINTENANCE CHART

These recommendations apply for normal recreational use. Heavy duty or full-time use may require more frequent maintenance intervals.

Always use specified sections or manufacturer's guide for further information and instructions.	Before Each Use	Weekly	Monthly	Every 3 Months	Every 6 Months	Every Year	As Necessary
Propane Gas System							
Have propane gas system checked for leaks						◆	◆
Pressure Regulator - inspect and adjust if needed						◆	
Check propane tank condition, mounting, and fittings						◆	
Electrical System							
Check Battery Condition Meter	◆						
Check battery fluid level and connections			◆				
Check 12V fuses and 120V breakers							◆
Check GFCI Receptacles			◆				
Generator							
Visually inspect generator and compartment	◆						
See generator manufacturer's maintenance guide							◆
Plumbing System							
Sanitize plumbing system							◆
Winterize plumbing system							◆
Clean water pump strainer filter						◆	◆
Slideout & Leveling System							
Check and Adjust							◆
Check Hydraulic Oil Level			◆				◆
Check Hydraulic Lines (routing, leaks, etc.)						◆	
Check and inspect room seals (bulb seals)					◆		◆
Check and inspect electric slideout lock drain line(s)							◆
Exterior							
Clean roof				◆			◆
Clean sidewalls			◆				◆
Clean windows							◆
Flush underside of vehicle				◆			◆

COACH MAINTENANCE CHART

These recommendations apply for normal recreational use. Heavy duty or full-time use may require more frequent maintenance intervals.

Always use specified sections or manufacturer's guide for further information and instructions.	Before Each Use	Weekly	Monthly	Every 3 Months	Every 6 Months	Every Year	As Necessary
Safety Equipment							
Check operation of the following items:							
Headlights, Taillights, and Marker Lights	◆		◆				
Turn Signals	◆		◆				
Horn	◆		◆				
Hazard Warning Flashers	◆		◆				
Windshield Wipers and Washers	◆		◆				
Fire Extinguisher - check charge indicator	◆		◆				
Smoke Alarm - test operation *	◆		◆				
Carbon Monoxide Alarm - test operation *	◆		◆				
Propane Gas Leak Detector - test operation	◆		◆				
(*replace battery if needed)							
Appliances							
Water Heater							
See water heater manufacturer's maintenance guide							◆
Inspect and clean exterior vent	◆						◆
Refrigerator							
See refrigerator manufacturer's maintenance guide							◆
Inspect and clean exterior vent/drip tray drain tube	◆						◆
Furnace							
See furnace manufacturer's maintenance guide							◆
Inspect and clean exterior vent	◆						◆
Air Conditioner							
See A/C manufacturer's maintenance guide							◆
Inspect for exterior damage				◆			◆
Check/replace filter			◆				
Range Top							
See range manufacturer's maintenance guide							◆
Inspect and clean/replace range hood grease filter							◆

**SECTION 11 –
MAINTENANCE AND STORAGE**

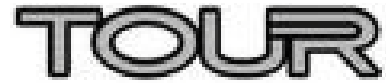

COACH MAINTENANCE CHART

These recommendations apply for normal recreational use. Heavy duty or full-time use may require more frequent maintenance intervals.

Always use specified sections or manufacturer's guide for further information and instructions.	Before Each Use	Weekly	Monthly	Every 3 Months	Every 6 Months	Every Year	As Necessary
Sealants							
Inspect (see "Sealants" at the beginning of this section for proper inspection technique)					◆		◆
Replace (see "Sealant Call-out Sheet in the supplement manual provided in your InfoCase)							◆
Frame & Chassis							
Follow chassis manufacturer's maintenance guide (refer to chassis manual)							◆
Inspect Hitch Receiver (if towing)	◆						
Tires							
Check and adjust air pressure	◆						◆
Check tread wear	◆						◆
Check front end alignment and adjust if needed							◆
Miscellaneous							
Lubricate locks, hinges, and latches						◆	◆

TOUR

SECTION 12 – MISCELLANEOUS

LOADING THE VEHICLE

NOTE: Your motor home's load capacity is designated by weight, not by volume, so you cannot necessarily use all available space when loading your motor home.

- Store or secure all loose items inside the motor home before traveling. Possible overlooked items such as canned goods or small appliances on the countertop, cooking pans on the range, or free-standing furniture items can become dangerous projectiles during a sudden stop or evasive maneuver.
- Be aware of GVWR, GAWR, and individual load limit on each tire or set of duals.

When loading the vehicle, distribute the cargo load equally so that you do not exceed either the Front or Rear Gross Axle Weight Rating (GAWR) or the Gross Vehicle Weight Rating (GVWR). The Gross Axle Weight Rating (GAWR) means the weight value specified by the chassis manufacturer as the load carrying capacity of a single axle system as measured at the tire-to-ground interfaces. This is the total weight a given axle is capable of carrying. Each axle has its own rating.

Have your vehicle weighed to determine the proper load distribution for your vehicle. Also distribute cargo side-to-side so the weight on each tire or dual set does not exceed one half of the GAWR for either axle.

For example, if the Front GAWR is 6,000 lbs., there should be no more than 3,000 lbs. on each tire. (If the left side weighs 3,100 lbs. and the right side weighs 2,700 lbs., at least 100 lbs. of the load must be shifted from the left side to the right side.) The GVWR is listed on the Vehicle Certification Label. (See sample in Specifications section).

The GCWR (Gross Combination Weight Rating) means the maximum allowable loaded weight of this motor home and any towed trailer or towed vehicle.

NOTE: We recommend that you dump all holding tanks before traveling to avoid carrying unnecessary weight.

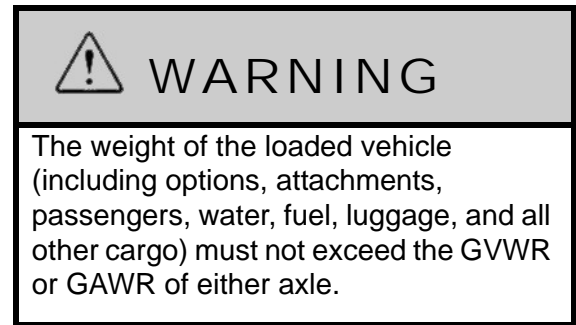

WEIGHING YOUR LOADED VEHICLE

To check the weight of your fully loaded coach, locate a commercial weighing scale that is capable of weighing large trucks.

NOTE: Sales literature may give approximate or standard weights. Your actual coach weight may differ based on added factory and/or dealer options.

Loading

Load your vehicle completely as if you were going on a long trip with everything you would carry, including food, clothing, bedding, lawn chairs, etc., a full fuel tank, full propane tank, and a partial tank of fresh water, but empty holding tanks.

Finding a Scale

In urban areas, the most common places to find a public access scale are commercial truck stops. In rural areas, most grain storage elevators have scales available. Most scales charge a nominal fee for weighing a vehicle.

Weighing

There is typically a scale operator to direct you but the basic routine is to take three separate weights - front axle, whole vehicle, and rear axle.

You will first drive only your front wheels onto the scale pad, then drive ahead so that the whole vehicle is on the scale, then finally pull off until just the rear wheels are on the pad.

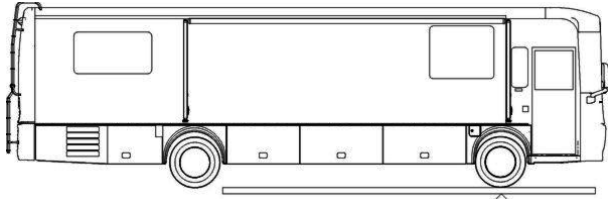

Front GAWR (Front Axle Only)

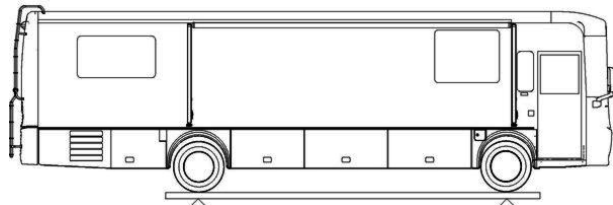

GVWR - Whole Vehicle (All Axles)

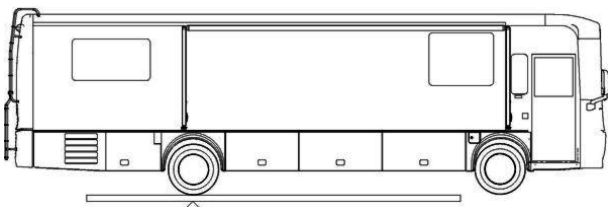

Rear GAWR (Rear Axle Only)

You will receive a weight “ticket” that states your current Front Gross Axle Weight, Rear Gross Axle Weight, and Gross Vehicle Weight. You can compare these weights to the weight ratings listed on your Vehicle Certification Label to use as a guideline for future loading limits and weight distribution.

The gross weight of the vehicle must not exceed the Gross Vehicle Weight Rating (GVWR) specified on the Vehicle Certification Label. The front and rear axle weight also should not exceed the corresponding Axle Weight Rating specified on the Vehicle Certification Label.

Corner Weighing (Side-to-Side)

The most accurate method of weighing a motor home is to weigh each “corner” of the coach separately (single L/R front wheels or L/R rear dual sets.) This method will help you determine how to distribute your cargo to avoid overloading, especially on tires.

To determine the weight distribution on each tire or dual set, you will need to find a scale capable weighing side-to-side, or all four “corners” of the vehicle, separately.

A truck scale may be used if the ground is level with the scale surface and the scale has clearance to drive one side of the coach onto the scale as shown.

Drive the coach on the level area next to the scale and straddle the scale so that only one side of the coach will be on the scale pad.

NOTE: Wind and precipitation can also cause weight inaccuracies.

Pull only the right front wheel onto the scale pad as shown.



Weighing Right Front Corner

When the front wheel has been weighed, pull the coach straight ahead until only the right rear wheel/dual set is on the scale pad as shown.



Weighing Right Rear Corner

Now, turn the coach around and repeat the process for the other side.

The load on each wheel or dual-wheel set should not exceed one-half of the corresponding GAWR. For example, if the GAWR for the rear

axle is 12,000 lbs., then the load on each rear dual set (left rear duals or right rear duals) should not exceed 6,000 lbs.

Tires must be filled to the recommended air pressure for the highest loaded tire set on that axle. For example, on the rear axle, if the left side weighs more than the right, fill the left tires to the pressure required for that weight, then fill the right tires to the same pressure as the left ones.

If your actual weight is considerably less than GAWR, you may be able to lower your tire pressure. See a tire dealer for a load/pressure chart.

NOTE: The Hitch Load from a Towed Vehicle or carrier box must also be counted on the Rear GAWR and subtracted from the rear axle cargo capacity.

Be aware that hitch load can affect handling characteristics. The more weight on the hitch, the lighter the front end will feel at the steering wheel.

CAR OR TRAILER TOWING

(Models 40BD, 40WD, and 40CD):

Hitch Pulling Capacity

10,000 lbs. max.

Tongue Weight

500 lbs. max.

(Model 42AD):

Hitch Pulling Capacity

15,000 lbs. max.

Tongue Weight

1,500 lbs. max.

The factory installed towing hitch on this coach is capable of pulling either 10,000 or 15,000 lbs. (max.), depending on model, however, the vertical (tongue) weight may vary according to chassis and model combinations. (*see label on hitch). Towing capacity may be

less than hitch rating.

When towing a trailer or vehicle, do not exceed either the GVWR, the rear axle GAWR, or the chassis GCWR by the combined loaded weight of the coach and the towed vehicle. See preceding items “Loading the Vehicle” and “Weighing Your Loaded Vehicle” for explanation of weight ratings.

Because of individual vehicle use and loading habits, we recommend weighing the vehicle while fully loaded to avoid exceeding any of the listed Gross Weight Ratings. See “Vehicle Certification Label” in the Introduction section for information on gross weight ratings.

Towing will affect vehicle handling, durability, and fuel economy. Exceeding any of the listed Gross Weight Ratings will result in unacceptable overall vehicle performance. Maximum safety and satisfaction when towing depends on proper use of correct equipment.

When towing a vehicle behind your motor home, the tow bar should be level or pointing slightly upward towards the tow vehicle.

When coupling the vehicle tow bar to the Factory Receiver Hitch using a “drop receiver” or a conventional “ball mount” (commonly referred to as a “stinger” or a draw bar”), do not exceed a 4” drop, nor one that the centerline of the hitch pin to the centerline of the ball exceeds 8”. (Reference Hitch Assembly sketch).

If a towing “brake system” is required, we recommend that a “modulated” towed vehicle braking device be installed. This means that when the motor home brakes are applied, whether hard or soft, a mirror effect occurs in the braking of the towed vehicle. In other words, the more force applied to the motor home brakes, the more force will be applied to the rear vehicle’s braking system.

We do not recommend the usage of a “surge-style” braking device. The usage of a surge brake (especially when coupled with a hitch ball located outside our recommended limits) places excessive stress on the hitch. This abuse of the ball mount and the hitch may cause premature hitch assembly failure.

Finally, do not forget to consider the actual tongue weight. This should not exceed the stated hitch vertical load for your vehicle. This weight is typically defined as the tongue weight of a towed vehicle hitch, boat trailer tongue weight, or a receiver-mounted carrier rack.

Check state regulations on trailer weight and trailer brake requirements to be sure you select the right equipment before towing.

Before descending a steep or long grade when towing a trailer, reduce speed and shift into a lower gear to control vehicle speed. Avoid prolonged or frequent application of brakes which could cause overheating and brake failure.

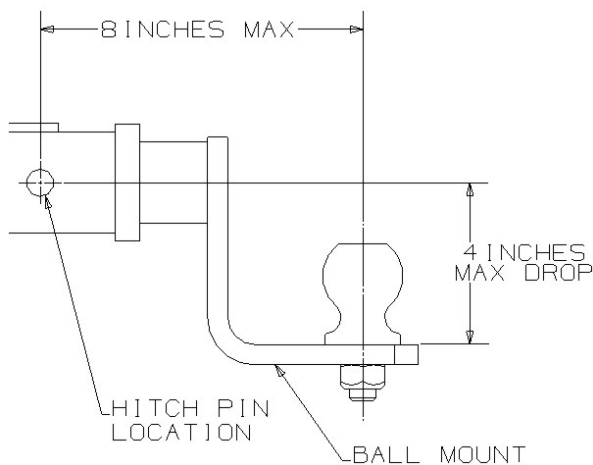

Hitch Assembly



WARNING

For safe towing and vehicle handling, maintain proper trailer weight distribution. The total weight of the motor home and the vehicle towed must not exceed the Gross Combined Vehicle Weight rating. See the “Body and Chassis Specification” chart in the Introduction section.

NOTICE

Exceeding any of the recommended gross vehicle weight ratings may result in vehicle damage. Do not install a frame equalizing-type hitch on your vehicle.

**TRAILER WIRING
CONNECTOR**

Your coach is pre-wired for trailer or car towing lights with a 7-pin socket. The connector plug is supplied in the coach parts package provided to you by your dealer when you took delivery of the vehicle.

The following diagram shows proper connection of trailer or tow vehicle wiring to the coach light system. The “pigtail” assembly with the (car/trailer end) connector plug should be wired by a qualified technician. Provision for an electric brake controller is located near the steering column.

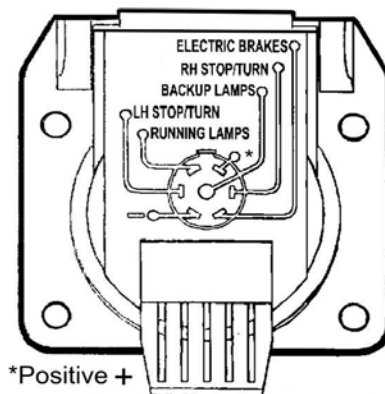

TOWING GUIDELINES

Gross Vehicle Weight Rating (GVWR)

This is the maximum allowable weight of the fully loaded vehicle. Included are fuel, water, LP, passengers, cargo, tools, and optional equipment

installed by the motor home manufacturer, dealer, or owner. This value is found on the VIN label, typically placed near the driver position.

Gross Axle Weight Rating (GAWR)

This is the total weight a given axle is capable of carrying, measured at the ground. Each axle has its own rating. These values are also found on the Vehicle Certification Label: front and rear.

Gross Combination Weight Rating (GCWR)

This is the maximum allowable weight of the motor home and loaded trailer, including the items noted in GVWR above. For purposes of this definition, the “trailer” can be a trailer, a vehicle towed on a dolly, or a vehicle towed by means of a tow bar. GCWR is typically specified based on durability and performance of the tow vehicle drive train: engine and cooling systems, transmission, drive line, drive axle, and others. The tow vehicle brakes may be rated for operation at GVWR, not GCWR.

*NOTE: State or provincial laws/regulations may require the “trailer” to be equipped with brakes that are activated when the motor home brakes are applied. **The user is responsible to know and understand the laws of the state or province being traveled.** The Department of Transportation in a given state or province should be able to provide specific information.*

Hitch Ratings

SAE Standard J684 defines:

- Class 1 trailers as “GVWR not to exceed 2,000 lbs”.
- Class 2 trailers as “GVWR over 2,000 lbs. and not to exceed 3,500 lbs. GVWR”.
- Class 3 trailers as “GVWR over 3,500 lbs. and not to exceed 5,000 lbs. GVWR”.
- Class 4 trailers as “GVWR over 5,000 lbs. and not to exceed 10,000 lbs. GVWR”.

Hitches are to be permanently marked with “Maximum trailer GVWR to be drawn” and “Maximum vertical tongue weight to be imposed.” The SAE standard does not specify a vertical load rating.

Traditionally, hitches are labeled 3,500/350 as Class 2, 5,000/500 as Class 3, and 10,000/1,000 as Class 4. The vertical tongue load value of 10 percent of drawn rating comes from the collective experience that 10 percent is the minimum value that provides stable towing of a trailer.

Ford’s towing guide suggests 10 to 15 percent for trailers over 2,000 lbs. Within GCWR, a Class 3 hitch allows “dingy” towing a large car or mid-size SUV; a Class 4 hitch allows “dingy” towing a large SUV or pickup. (Hitch ratings are independent of towing vehicle ratings.)

NOTE: Some Winnebago Industries® models equipped with a Class 3 hitch may have a label limiting vertical tongue load to 350 lbs. All Winnebago Industries models equipped with a Class IV hitch have a label limiting vertical tongue load to 500 lbs. On a 228" wheelbase, a 500-lb. load on a hitch 11' from the rear axle will apply about 800 lbs. at the axle.

The user must verify that the hitch equipment being used is adequate for the application.

FIREPLACE

–If Equipped

To Operate Fireplace:

- Turn fireplace ON.
- Turn the thermostat control clockwise all the way to turn the heater on.

NOTE: When the room reaches desired temperature, turn the thermostat control counter-clockwise until you hear a “click”. Leave in this position to maintain the room temperature.

- Turn the Flame Brightness Control knob to increase/decrease the flame brightness.

Whenever there is a loss of AC power to the fireplace, the remote control provided in your InfoCase will need to be reprogrammed.



Fireplace Remote Control

Further Information

See the fireplace user guide provided in your InfoCase for complete operating and maintenance instructions.

ENTRY STEP – ELECTRIC
–If Equipped

	WARNING
Do not use step unless fully extended. Do NOT stand on step when vehicle ignition switch is turned to either the “On” or “Start” position. The step will automatically retract, which may cause personal injury.	

The power switch for the electric entry step is located to the left of the main entry door as you enter the coach.



Entry Step Switch
(Located near the entrance door)
-Typical View

The step has several automatic extend/retract functions that are controlled by the position of a sensor mounted on the inner edge (hinge side) of the screen door.

Automatic Mode - Entry Step Switch ON
(Step Operates with Door)

With the Step switch in the ON position, the step is in Automatic Mode. This means it will extend and retract automatically whenever the screen door is opened or closed.

Stationary Extended Mode - Step Switch OFF
(Step Remains Extended)

With the Step power switch in the OFF position, the step will extend when the screen door is opened and will stay extended whether the door is opened or closed.

NOTE: The step switch is “locked” in the OFF position. You must press the red button to unlock the switch.

This position is normally used to keep the step extended when parked at a campsite or whenever people will be going in and out the vehicle frequently.

Automatic Retraction Feature

The step is equipped with an automatic retraction feature that stores the step automatically if the main entry door is closed and the Ignition Switch key is turned to the On or Run positions.

The step WILL RETRACT even if the Step switch is OFF.

This feature is intended to prevent injury or damage by an extended step while the vehicle is moving.

Further Information

For additional information on the step, see the manufacturer's operators manual included in your InfoCase.

STEPWELL COVER

The stepwell cover can be extended to cover the stepwell area and increase usable floor space in the front of the coach while the entrance door is not in use.



Step Cover shown in extended position

Press and hold the Step Cover switch (located on the passenger side armrest). Release when the step has extended or retracted fully.



Step Cover Switch
(Located on passenger side armrest)
-Typical View

CAUTION

Stay clear of the entrance step area when the step cover is being extended or retracted. Loose clothing may catch on components of the mechanism when entering or exiting the coach. Failure to observe can cause injury.

Emergency Retract Feature

The step cover is equipped with an Emergency Retract function in event of an emergency exit situation and/or the step cover fails to retract while in the extended position.

Do not use Emergency Retract feature unless necessary for emergency. Operation of the Emergency Retract feature will cause the step cover to become non-functional until the cable mechanism is reconnected by your dealer.

An emergency cable release is connected to a black plastic snap-in plate labeled "Emergency Retract" located at the front edge of the step cover.

To release the step cover for exit emergency, remove the black plastic plate by pulling it upward and to the side.

A bead-chain is attached to the black plastic cover and as you remove it, the chain will pull the release allowing you to manually push the cover in.



Lift snap-in plate from front edge of step cover



Pull chain to release step mechanism
and manually slide step cover back

- Pull out the lever on the crank-out handle and begin cranking out the window counter-clockwise to the position desired.

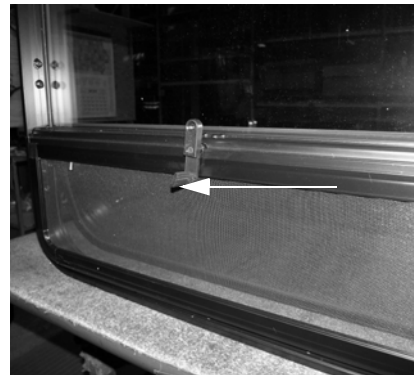

- To close, crank the window in snugly (by turning the crank-out handle clockwise), then back off 1/4 turn to help avoid glass warping, which can result in wind noise.
- Push the lever back in on the crank-out handle and lay back in the horizontal position.

If the window will not open after three or more full turns of the knob, the glass may be stuck to the sealing gasket. Go to the outside of the coach and gently free the glass with your fingers. A periodic light dusting of talcum powder on the gasket should prevent this from recurring.

Horizontal Slider Windows

Swing the latch handle straight out or up (depending on the style of window). Grasp the sliding window edge frame and slide the window to the side. Be sure the latch is open before trying to slide the window closed.

WINDOWS

Crank-Out Windows

- Turn the crank-out handle from the horizontal position to the vertical position.

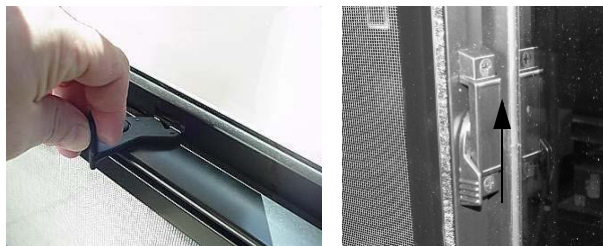

Vertical Slider Windows

Vertical windows have spring-loaded catches on both sides of the window that pop out to hold the window in its fully raised position. Press the catches outward toward the frames while lowering the window.

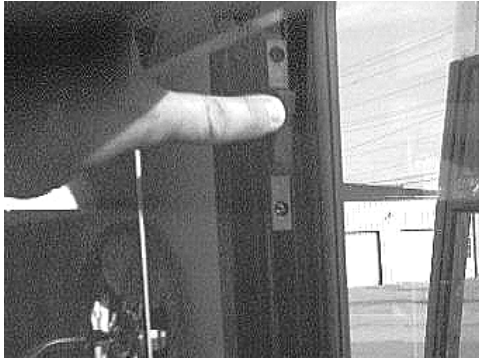

Vertical Window Catches

POWER ROOF VENTILATOR – GALLEY

–If Equipped

The 3-speed turbine vent is controlled by a switch on the wall to raise or lower the dome.

The turbine fan will start automatically as the vent is raised, and stop as the vent is lowered.

A thermostat near the OnePlace® monitor panel can also be set to automatically open and close the vent at a selected temperature.

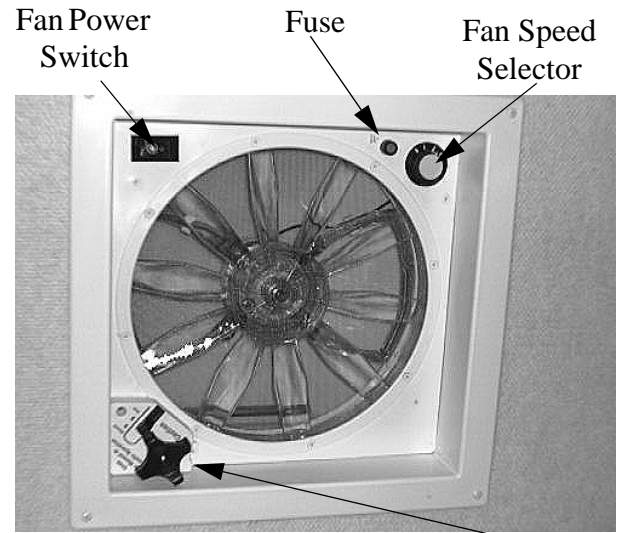

Power Ventilator

To Operate Ceiling Ventilator

1. Press the wall switch to raise the dome about 3" or more to allow the turbine fan to operate. *(A built-in safety switch will not let the fan motor run unless the dome is partially open).*
2. The turbine fan will start automatically as the vent dome is raised and stop as the vent dome is lowered and closed. *(Fan Power switch must be ON and Fan Speed knob in a position other than 0-Off.)*
3. Turn the Fan Speed knob to the desired level (1-Low, 2-Med, 3-Hi).
4. Open a window or door to provide airflow. Direction of airflow is determined by which window or door is opened.

NOTE: For best results, close all other roof vents, windows, and doors, then open one (1) window the farthest distance from the roof ventilator. The fan speed selector on the ventilator allows you to control the amount of circulation you need at any time.

5. If you want the vent dome raised without the fan running, turn Off either the Fan Power switch or Fan Speed knob (0-Off).

NOTE: In event of power failure the ventilator dome may be opened or closed manually using the Dome Crank knob.

Ventilator Thermostat

-If Equipped

The thermostat lets you set a temperature at which you want the ventilator to open automatically and exhaust room air.

This function can be disabled by sliding the temp selector lever to the OFF position.

Temperature Selector
On/Off Switch

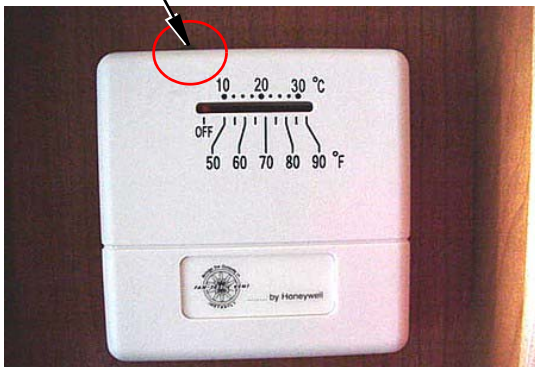

Further Information

See the power ventilator manufacturer's operating instructions supplied in your InfoCase for further instructions, care, and cleaning information.

**POWER ROOF VENTILATOR –
BATH**

-If Equipped

The 3-speed turbine vent is controlled by a switch on the wall to raise or lower the dome.

The turbine fan will start automatically as the vent is raised, and stop as the vent is lowered.

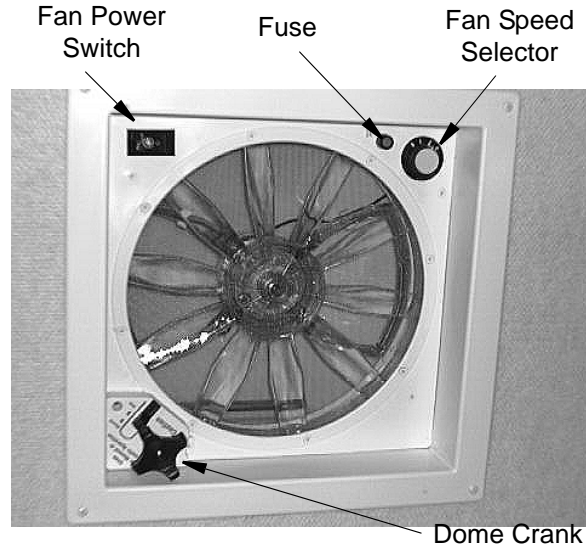

Power Roof Ventilator

To Operate Ceiling Ventilator

1. Press the wall switch to raise the dome about 3" or more to allow the turbine fan to operate. *(A built-in safety switch will not let the fan motor run unless the dome is partially open).*
2. The turbine fan will start automatically as the vent dome is raised and stop as the vent dome is lowered and closed. *(Fan Power switch must be ON and Fan Speed knob in a position other than 0-Off).*
3. Turn the Fan Speed knob to the desired level (1-Low 2-Med 3-Hi).
4. Open a window or door to provide airflow. Direction of airflow is determined by which window or door is opened.

NOTE: For best results, close all other roof vents, windows, and doors, then open one (1) window the farthest distance from the roof ventilator. The fan speed selector on the fan allows you to adjust the amount of circulation you need at any time.

5. If you want the vent dome raised without the fan running, turn Off either the Fan Power switch or Fan Speed knob (0-Off).

NOTE: In event of power failure, the ventilator dome may be opened or closed manually using the Dome Crank knob.

Further Information

See the power ventilator manufacturer’s operating instructions supplied in your InfoCase for further instructions, care, and cleaning information.

TOOL AND LADDER STORAGE

The roof ladder extension and various tools supplied with your coach are stored in one or more of the exterior storage compartments.

NOTE: Actual features and locations may vary depending on model, available equipment, and storage compartment configuration.



Folding Step Ladder
(optional)

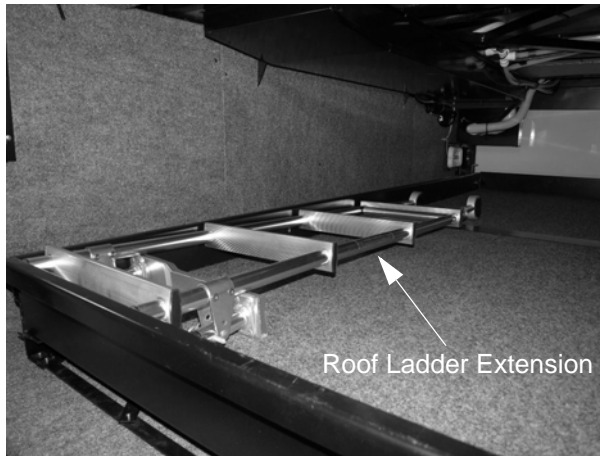

Roof Ladder Extension

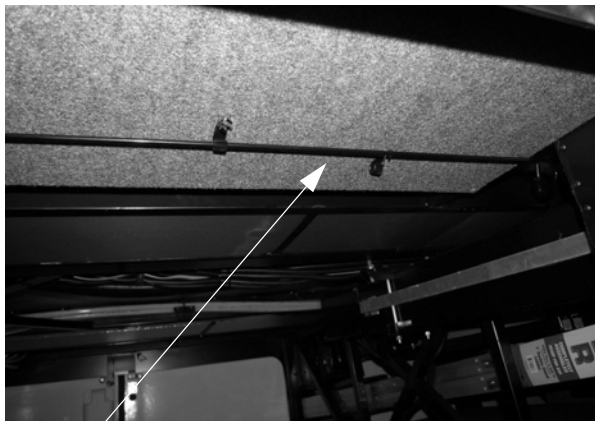

Awning Rod

ROOF LADDER



WARNING

Stay off roof. Roof surface may be slippery. Falling could result in death or serious injury.

The ladder on your motor home is provided for limited access to the roof.

Walking or working on the roof should be left up to qualified service personnel using proper safety equipment in a safe environment. You should only walk or work on the roof if you are qualified and have created a safe environment.

For your safety, it is not recommend that you store or carry items on the roof.

Before Using the Ladder

- **Inspect the ladder** to make sure it is not damaged. Never use a damaged ladder.
- **Keep the rungs of the ladder clean and dry** while in use. Never use the ladder when it is raining, snowing or icy. The rungs can become slippery. Do not step onto the rungs if the rungs are wet, or if your shoes are wet or carry mud or debris that could result in a loss of footing.
- **Never ignore warning labels** or weight limits defined on your ladder. The following warning label is located on or near the ladder:

⚠ WARNING

Do not exceed 225 lbs. maximum weight capacity. Misuse of ladder could result in death or serious injury. See Operators Manual before using ladder.

- **Maximum Capacity: 225 lbs.**
- **Do not overload.** Ladder is intended for one person.
- **Make sure you are physically capable** to safely use the ladder. Strength, flexibility and stability are required.
- **Be aware that the vehicle may sway** as you climb the ladder. Do not use the ladder in high winds.
- **As you climb the ladder,** grasp the side rails firmly and always use both hands. Keep your body centered between the side rails. Do not over-reach.
- **Always store** the ladder extension when not in use.
- **Never allow children** on the ladder.
- **Do not transport items** anchored to the ladder. You could damage the ladder.

To Use the Ladder Extension:



C-Shaped Retainer Brackets Ladder Support

Ladder Extension (Typical)

- Remove extension from storage clips in cargo compartment.
- Unfold the ladder support and pin into place as indicated on the following photo.



- Hold the ladder extension horizontally with the ladder support pointing downward.
- Slide the open ends of the C-shaped retainer brackets over the lowest ladder rung as shown in the following photo.



- Lower the extension into place and pull downward to 'seat' the retainers onto the ladder rung.
- Make sure retainer brackets are properly engaged onto ladder rung before using ladder.
- Reverse steps to remove and store.

**STORAGE COMPARTMENT
DOORS**

The high-density gaskets used on the exterior storage compartments are designed to provide a more positive seal against dust and weather. Sometimes this seal firmness can inhibit

complete latching of the compartment doors if they are simply “dropped shut” or closing force is applied only to the center of the door.

To ensure that exterior storage compartment doors have latched properly, press firmly on the bottom edges (side edges - if equipped) of the doors with the palms of your hands. If the door is ajar you will hear and feel a loud “click” when the latches engage properly.

POWER AWNING

-If Equipped

The awning control switches are on the switch panel just inside the entrance door.



Awning Control Switches
(Located near entrance door)
-Typical View

Steps to Operating the Controls

1. Turn the Power Switch On.
2. Use the Porch Awning Switch to extend or retract the awning as desired.
3. Set the Sensitivity Switch to the level desired.

Power Switch

Power ON - The On position activates the Porch Awning Switch and the Auto-Retract system as well as provides power to the awning.

Power OFF - The Off position shuts down the system. The awning cannot be extended or retracted in this mode. The Auto-Retract system is also disabled.

Wind Sensor Auto-Retract Feature

If the Wind Sensor is activated, the system will automatically retract the porch awning during windy conditions. Sensitivity threshold is set on the control panel.

Wind Speed Switch

(High, Medium, Low)

Low requires the least amount of motion before automatically closing the awning. High requires more motion before the system automatically closes the awning. You may want to experiment first to find the setting that best suits your needs.

NOTE: The Windsensor Auto-Retract system is On when the power is On and is Off when the Power Switch is set to Off. If the power is shut off while the awning is extended, the awning is not protected by the Auto-Retract system.

The system uses a sensor in the motor head to detect awning motion during windy conditions and gauges vertical motion. When persistent motion exceeds the factory preset threshold for two seconds or longer, the awning will retract automatically.

Gust detection is incorporated into the Direct Response software. When the motion value is suddenly and sharply increased above a safe maximum value, the two second persistence measure is overridden and the awning will close immediately.

CAUTION

The Auto-Retract feature provides protection against adverse elements, but no Auto-Retract system is a guarantee against severe or destructive weather. The effects of wind and rain on an awning are unpredictable and may cause severe damage to the awning and/or vehicle. If a situation arises where wind or extended periods of rain are expected, retract the awning.

Ignition Lockout System

The ignition lockout system will disable the extend function while the vehicle ignition key is in the On position. With this feature, the awning will only extend when the vehicle ignition key is in the Off position. The awning can retract anytime regardless of the ignition key position.

Using the Key FOB Remote Control

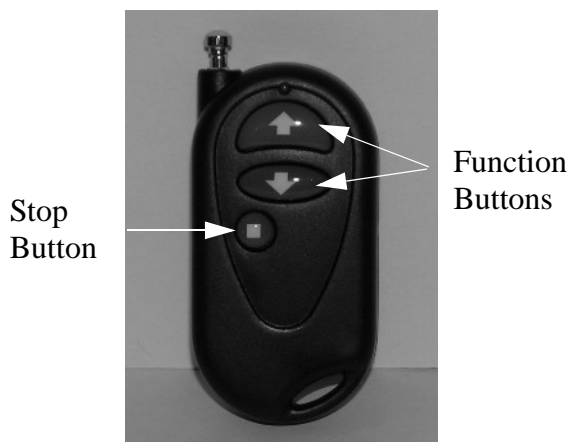

Porch Awning Key FOB Remote

To use, turn the system power On. The remote lets you operate the awning from a convenient location.

The remote has a maximum operating range of 50 feet. Actual distance may vary, depending on the specific installation and location of the receiver in the vehicle.

TO USE: Turn system power On at the control panel.

NOTE: Power On/Off and the Auto-Retract sensitivity can only be operated at the control panel.

- Extend - Press and release. The awning will extend out to the fully extended position and stop automatically.
- Retract - Press and release. The awning will retract and stop automatically when the awning is fully retracted.
- Stop - Press and release. During extend and retract functions, the awning may be stopped by pressing this button.

Door Awning Switch

This is a two-position switch. The following description also applies to any additional Door Awning Switches that may be installed.

Extend - Press and hold the switch. The awning will open as long as the switch is pressed.

Retract - Press and hold the switch until fully closed.

NOTE: As a safety feature, the awning will not extend if the ignition key is on.

Further Information

For complete operating instructions, refer to the manufacturer’s information provided in your InfoCase.

POWER AWNING (OVER THE DOOR)

–If Equipped

To Open the Awning

Press and hold the Door Awning Switch “Out” until the awning is in the desired position, then release.

To Close the Awning

Press and hold the Door Awning Switch “In” until the awning is in the stored position, then release.

NOTE: As a safety feature, the awning will not extend if the ignition key is on.



Over the Door Awning Switch
(Located near the entrance door)
-Typical View

Further Information

For complete operating instructions, refer to the manufacturer's information provided in your InfoCase.

AIR HOSE CONNECTOR

–Freightliner® Chassis

For convenience, your coach is equipped with a quick-connect air coupler to which you can connect an air hose for inflating tires or sports and camping equipment if needed.

NOTE: Air hose and inflation or blowing attachments are not supplied and must be obtained separately.

The quick-connect coupler is located behind the hood panel at the front end of the vehicle. Instructions for connection and disconnection are shown on the label at the coupler.



Quick-connect air coupler at front end of coach

The air is supplied by the chassis air brake/suspension system air accumulator tank.

When the air pressure is less than what you need to inflate an item, you must start the coach engine to run the system air compressor to fill the accumulator tank.

EFFECTS OF PROLONGED OCCUPANCY

Your motor home was designed primarily for recreational use and short-term occupancy. If you expect to occupy your coach for an extended period, be prepared to deal with condensation and humid conditions that may be encountered.

Humidity and Condensation

Moisture condensing on the inside of windows is a visible indication that there is too much humidity inside the coach. Excessive moisture can cause water stains or mildew, which can damage interior items such as upholstery and cabinets.

When you recognize the signs of excessive moisture and condensation in your coach, you should take immediate action to minimize their effects.

You can help reduce excessive moisture inside the motor home by taking the following steps:

Ventilate with outside air

Partially open one or more windows and a roof vent to circulate outside air through the coach. In cold weather, this ventilation may increase use of the furnace, but it will greatly reduce the condensation inside the coach.

Minimize moisture released inside the coach

Run the range hood fan while cooking and open a bath vent while bathing or showering to carry water vapor out of the coach. Avoid making steam from boiling water excessively or letting hot water run. Avoid bringing extra moisture into the coach by way of soaked clothing or snow on shoes. Do not hang-dry wet overcoats or clothing inside the coach.

TOUR

INDEX

12-Volt Front Drop-Down Solar/ Night Shade	3-9	Disinfecting Your Fresh Water System	7-6
2010 New Vehicle Limited Warranty	1-7	Doors and Windows	11-8
About this Manual	1-1	Driving Safety	2-1
Air Conditioner Filter	4-22	DVD Home Theater System	8-2
Air Conditioner/Heater – Automotive (Dash)	3-17	Effects of Prolonged Occupancy	12-15
Air Horns	3-20	Electrical	2-5
Air Hose Connector	12-15	Electrical Cautions	6-1
Audio-Video System Basic Operation	8-2	Electrical Generator	6-6
Bathroom	11-8	Electrical Outlets – House 120-Volt AC	6-5
Battery Access	6-11	Electrical System – House 120-Volt AC	6-1
Battery Boost Switch	3-16	Electrical System – House 12-Volt DC	6-10
Battery Care	6-12	Electronic Compass and Outside Thermometer	3-10
Battery Information	6-11	Electronic Thermostat - Model 42AD	4-15
Bed - Power Lift	9-10	Electronic Thermostat	4-14
Booth Dinette - 40WD Models	9-3	Emergency Exits	2-5
Cabinetry – Cleaning	11-6	Energy Management System (EMS)	4-9
Car or Trailer Towing	12-3	Energy Management System (EMS)	4-9
Carbon Monoxide Alarm	2-3	Engine Block Heater – Diesel Engine	3-21
Carbon Monoxide Warning	2-3	Engine Brake System	3-11
Care of Appliques and Decals	11-4	Engine Cooling System	3-26
CB Radio Power Wiring	3-19	Engine Overheat	2-10
CD/DVD Player - Bedroom	8-3	Engine Service Access Grille – Rear	3-21
CD/DVD Player	8-4	Engine Top Access Covers – Rear	3-22
Central Air Conditioner	4-22	Engine Top Access Covers – Rear Bath Models	3-24
Central Vacuum Cleaner	4-26	Entry Step – Electric	12-6
Chassis Battery Disconnect Switch	3-27	Extendable Sectional Sofa	9-7
Chassis Diagnostic Connectors	11-11	Exterior Automotive Paint Finish	11-2
Chassis Fuses and Relays	11-10	Exterior Entertainment Center	8-9
Chassis Service and Maintenance	11-10	Exterior Shower/Wash Station	7-8
Checking Hydraulic Oil Level	10-12	External Power Cord	6-1
Child Restraints	3-4	Filling the Fuel Tank – Diesel Engine	3-20
Circuit Breakers – House 120-Volt AC	6-5	Filtered Water Faucet	7-4
Circuit Breakers – House 12-Volt	6-13	Fire Extinguisher	2-4
Circuit Breakers and Fuses – Chassis/Dash Automotive 12-Volt	3-27	Fireplace	12-5
Coach Maintenance Chart	11-12	Formaldehyde Information	2-7
Day/Night Pleated Blinds	9-10	Fresh Water System	7-1
Defrost Fans	3-17	Front Axle Tire Alignment	1-2
Dinette/Bed Conversion	9-2	Front End Masks and Paint Damage	11-4
Dishwasher	4-26	Front Service Access	3-28
		Front TV Ignition Switch Interlock	8-2

Fuel and Propane Gas	2-1	Power Awning (Over the Door)	12-14
Fuel Selection – Diesel Engine	3-20	Power Cord Reel	6-3
Fuel/Water Separator – Diesel	3-26	Power Door Locks	3-5
Full-Coach Water Filtration System	7-5	Power Roof Ventilator – Bath	12-10
Furnace-A/C Thermostat Operation Chart	4-21	Power Roof Ventilator – Galley	12-9
Galley Sink	11-7	Power Sofas and Beds	2-6
General Slideout Care	10-9	Pre-Delivery Inspection	1-2
General Warnings	2-1	Pressure-Temperature Relief Valve	4-11
GPS Navigation System	3-10	Propane Gas Furnace	4-12
Ground Fault Circuit Interrupter	6-5	Propane Gas Leak Detector	2-2
Hazard Warning Flashers	3-13	Propane Gas Pressure Regulator	5-4
Headlights and Exterior Lights	11-4	Propane Gas Supply	5-1
Heat Pump	4-21	Propane Gas Warnings and Precautions	5-3
Heated Seats	3-2	Propane Vaporization in Cold Weather	5-5
High Definition Video Selection System	8-1	Radio – In-Dash	3-17
House Battery Disconnect Switch	6-11	Range and Refrigerator	11-8
Hydronic Heating System	4-17	Range Top	4-4
Ice Maker	4-2	Rear Furnace	4-13
Interior Soft Goods	11-5	Rearview Monitor System	3-8
Inverter/Charger Unit – 2000W	6-3	Rearview Monitor System	3-9
Jump Starting	2-9	Refrigerator	4-1
KeyOne™ Lock System	3-5	Refrigerator Service Access Compartment	4-3
Leveling System	10-10	Refrigerator/Freezer - Portable	4-3
Lights	3-29	Reporting Safety Defects	1-2
Loading	2-5	Rest Easy® Multi-Position Lounge	9-5
Loading the Vehicle	12-1	Roadside Emergency	2-8
Lounge Chair Base Clamp	9-1	Roller Shades (Manual) - Solar Day/Night	9-11
LP Gas Leaks	2-2	Roof	11-1
Maintenance	2-5	Roof and Ladders	2-8
Map Light Switch	3-13	Roof Ladder	12-11
Microwave Oven/Range Hood	4-6	Safe Use of the Propane Gas System	5-2
Mirrors – Power Electric	3-6	Safety Messages Used in this Manual	1-1
Mold, Moisture, and Your Motor Home	2-7	Sealants –	
MotorAid Water Heater	4-12	Inspection and General Information	11-1
Mountain Driving	3-29	Seat Belts	3-3
Occupant and Cargo Carrying Capacity		Seats – Driver/Co-Pilot	3-1
Label	1-3	Service and Assistance	1-2
OnePlace® Systems Monitor Panel	4-6	Shower Hose Vacuum Breaker	7-8
Owner and Vehicle Information	1-6	Signal Lever/Headlight Hi/Lo Beam	3-13
Parking Brake	3-11	Sirius® Plug and Play Satellite Radio	3-19
Passenger Footrest	3-2	Sleep Number® Bed	9-10
Plastic Parts – Cleaning	11-5	Sleeping Facilities	9-2
Portable Satellite Dish and Cable TV		Slideout Emergency Retraction Procedures	10-6
Hook-ups (Input)	8-9	Slideout Room –	
Power Awning	12-13	Extreme Weather Precaution	10-5

Slideout Room KeyLock	10-2	Water Heater - Gas/ Electric	4-10
Slideout Room Operation – Hydraulic	10-2	Water Heater Bypass Valve	7-13
Slideout Room Retraction (with Power Lift Bed Option)	10-2	Water Pump	7-2
Slideout Room Travel Locks - Electric	10-1	Water System Drain Valve Locations	7-21
Slideout Room Troubleshooting – Hydraulic	10-5	WaterLine and Tank Drain Valves	7-12
Slideout Rooms	2-6	Weighing Your Loaded Vehicle	12-1
SmartWheel™ Steering Wheel Control System	3-14	Windows	12-8
Smoke Alarm	2-4	Windshield Washers and Wipers	3-28
Sofa/Bed Conversion	9-4	Winterizing Optional Appliances	7-18
Sofa/Bed Conversion	9-4	Winterizing Procedures	7-13
Solar Charger Panel	4-8	Wood Furniture and Cabinetry	9-12
Solid Surface Countertop – Corian®	11-7		
specifications and Capacities	1-5		
Starting and Stopping Diesel Engine	3-21		
Steering Column Adjustment	3-14		
Stepwell Cover	12-7		
Storage Compartment Doors	12-12		
Suspension Alignment and Tire Balance ...	3-29		
Table and Chairs	9-1		
Tag Axle Suspension System	3-12		
Theater Seating/Bed Conversion	9-8		
Tires	3-29		
Toilet - Electric Flush	7-8		
Toilet	7-8		
Tool and Ladder Storage	12-11		
Towing Guidelines	12-4		
Trailer Wiring Connector	12-4		
TV (Bedroom) - Power Lift	8-5		
TV Antenna	8-6		
TV Digital Satellite Dish – In-Motion	8-8		
TV Digital Satellite System – Automatic ...	8-7		
TV Digital Satellite System Wiring	8-8		
TV Signal Amplifier	8-7		
Undercarriage	11-1		
Utility Light	7-11		
Vehicle Certification Label	1-4		
Vehicle Storage – Preparation	11-9		
Vehicle Storage – Removal	11-9		
Washer/Dryer - Prep Package	4-26		
Washer/Dryer - Stackable	4-25		
Washer/Dryer	4-24		
Waste Water System	7-9		
