

• **Winnebago**  
• **Itasca**  
**Operator's Manual**

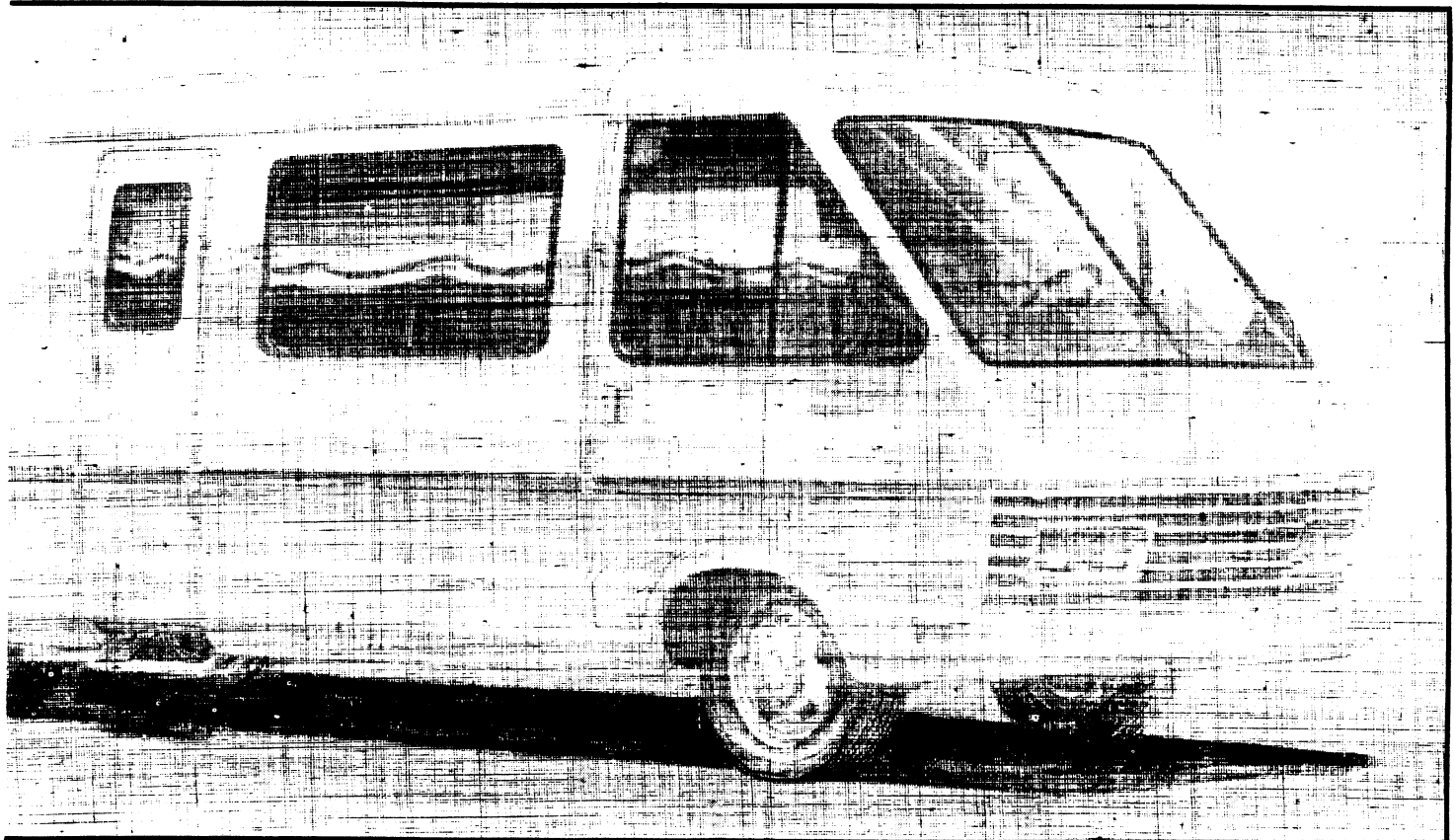

# TO THE OWNER

Congratulations! We welcome you to the exciting world of motor home travel and camping. You will find it convenient and enjoyable to have all the comforts of home and still enjoy the great outdoors, wherever you choose to go.

Your motor home has been carefully designed, engineered and manufactured to provide dependability as well as safety. Before sliding into the driver's seat, take a few minutes to become familiar with the operation and features. This manual was prepared to aid you in the proper care and operation of the vehicle and equipment. We urge you to read it completely. In addition, spend some time with the dealer when you take delivery, you will want to learn all you can about your new motor home.

Your Winnebago motor home is covered by a factory warranty against defects in material and workmanship. This warranty should be validated at once and returned to the factory by your dealer.

Throughout this manual, reference is made to the following terms: Important, Caution and Warning. These terms indicate important information which must be understood and followed. The definitions of these terms are:

## **IMPORTANT**

Indicates a special point of information.

## **CAUTION**

Indicates that a failure to observe can cause damage to equipment.

## **WARNING**

Indicates that failure to observe can cause damage to equipment or personal injury.

\_\_\_\_\_  
**OWNER'S NAME**

\_\_\_\_\_  
**STREET ADDRESS**

\_\_\_\_\_  
**CITY AND STATE (OR PROVINCE IN CANADA)**

\_\_\_\_\_  
**VEHICLE IDENTIFICATION NO.**

\_\_\_\_\_  
**DATE OF DELIVERY TO FIRST RETAIL PURCHASER**

\_\_\_\_\_  
**VEHICLE MILEAGE AT TIME OF SUCH DELIVERY**

\_\_\_\_\_  
**SELLING DEALER NAME AND ADDRESS**

\_\_\_\_\_  
**SELLING DEALER CODE NUMBER**

\_\_\_\_\_  
**CHASSIS SERIAL NUMBER**



# OPERATOR'S MANUAL SUPPLEMENT

## DOOR LOCKS AND HANDLES -

This supplement describes items relative mainly to the new Elandan & Windcruiser motor homes. Most equipment, appliances and procedures listed for the A-Body motor homes apply also to the Elandan & Windcruiser motor homes. Exceptions are denoted in this supplement.

### PARKING BRAKE (Elandan & Windcruiser)

Follow instructions for W/ICN 30 RT and W/ICN 33RU on page 13.

### ENTRANCE STEP - Manual

To extend the entrance step, lift up on the front of the step and pull out until it drops into position. To retract, lift up on front of step and push back until step locks into travel position.

### ENTRANCE STEP - Electric (Optional)

The electric power entrance step extends and retracts automatically as the entrance door is opened and closed. If the door will be repeatedly opened and closed while parked at a sight, you may want to cancel the power to the step for convenience and to conserve wear on the mechanism. A rocker switch for this purpose is located on the side of the cabinet near the entrance. The step will remain in whichever position it was when power was cancelled for as long as the switch is off. Turn the switch on to reactivate the power mechanism.

#### CAUTION

Always remember to retract the entrance step before traveling or moving vehicle.

### Exterior (Elandan & Windcruiser)

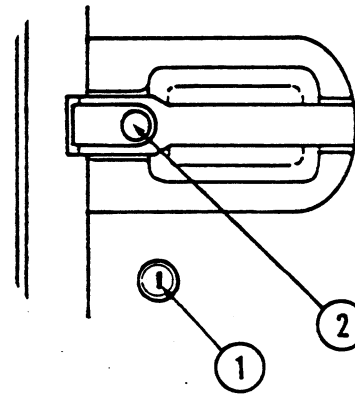

1. Keyhole
2. Push Button

To open the entrance and cab doors from outside, insert the key into the lock, turn the key toward the front of the vehicle and press the push button in the handle assembly. To lock from the outside of the vehicle, insert the key into the lock and turn the key toward the rear of the vehicle until the lock mechanism engages.

### Interior (Elandan & Windcruiser)

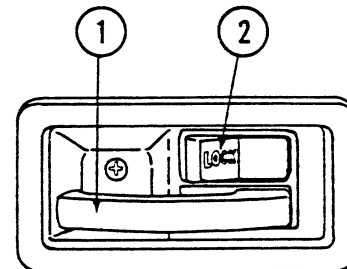

1. Lever
2. Lock Switch

To open the entrance and cab doors from inside, pull the door lever outward. To lock the doors from inside the vehicle, push the lock rocker switch toward the side labeled "LOCK".

## **PULL-DOWN FRONT BUNK (Elandan & Windcruiser) - Optional**

A pull-down bunk is optional on all Elandan and Windcruiser motor homes to provide additional sleeping capacity. To move the bunk into sleeping position, unfasten the two latches located at the rear edge of the bunk, grasp the handle(s) and pull downward. To return the bunk to the raised position, push the bunk forward slightly and push upward. Before raising the bunk, make sure that there are no items on the mattress which may possibly strike the ceiling when raised. Refasten the latches to secure the bunk against the ceiling.

## **PEDESTAL STORAGE**

In the Elandan and Windcruiser motor homes, the dinette table and pedestal tubes are stored inside the wardrobe. The tubes are held by clamps located on the inside rear wall and the table is secured to the wall by a rubber strap.

## **FUSES - Automotive (Elandan & Windcruiser)**

The automotive electrical fuse panel is located beneath the dash to the left side of the steering column. Should any of the automotive electrical systems fail because of a blown fuse, replace fuse immediately with the same type and amperage rating. Repeated fuse failure may indicate a serious malfunction and should be tested by a Winnebago or Itasca dealer immediately.

## **BATTERY ACCESS - Exterior (Elandan & Windcruiser)**

See ENGINE ACCESS (Elandan & Windcruiser)

## **BATTERY ACCESS - Interior (Elandan & Windcruiser)**

The two auxiliary batteries are located in separate compartments in the pilot and co-pilot door stepwells. Access to either battery is gained by removing a metal cover behind the carpeted plastic stepwell panel. Remove the four screws that retain the stepwell panel, slide the panel up and remove. Next, extract the screws fastening the metal cover to the stepwell and remove the cover. To slide the battery tray out for servicing, pull up on the tray retainer pin and pull tray outward.

## **AIR HORNS - Optional (Elandan & Windcruiser)**

The air horns are sounded using the horn button on the steering wheel while the air horn switch is activated. This switch is located on top of the side panel to the left of the dash. With the switch off, the air horns are de-activated and only the chassis horn will sound.

## **SMOKE DETECTOR**

Certain models are equipped with a smoke alarm to comply with fire codes for particular floor plan configurations. If your motor home is so equipped, the alarm will be located on the ceiling in the forward half of the vehicle.

### **WARNING**

Test smoke detector operation after vehicle has been in storage, before each trip, and at least once per week during use.

## **APPLIANCES**

**Dometic® Ice Maker - Optional**  
WCN26RB, ICN26RB, WCN26RH,  
ICN26RH, WCN30RC, WCN33RU,  
ICN33RU, WCP31RT, ICP31RT,  
WCP34RU & ICP34RU

The ice maker will provide a continuous, automatic supply of ice with very little attention under normal use. For best results, the following suggestions are offered.

1. Starting - We suggest you throw away the cubes made during the first few cycles as they may contain particles of dirt or other contaminants normally found in newly installed water lines. The average time for first cycle is approximately 45 minutes. Cycle time for each batch thereafter is only 10-15 minutes.
2. The ice making mechanism will shut off when the ice maker is full, but the refrigeration system will continue to maintain the ice supply. The cubes may stick together under this condition, but may be easily separated by hand or a blunt tool such as a butter knife handle. **NEVER USE A KNIFE, PICK OR ANY OTHER SHARP INSTRUMENT TO DISLodge CUBES. THIS MAY DAMAGE THE PLASTIC INTERIOR.**

3. The grill on the front of the ice maker must be unobstructed to provide free flowing air circulation to the compressor and condenser for proper operation. Never place clothing or packages, etc., in front of the grill.

4. The ice maker should be periodically defrosted if used regularly. When defrosting, shut the ice maker off, remove remaining ice cubes and prop the door open a few inches.

5. Shut-down - The ice maker must be shut off, ice removed and the door propped open at least two inches to allow air circulation to dry the interior for prevention of mold and odor.

### IMPORTANT

This appliance operates on 110 volt AC current only and is dependant on utility power supply or 110 volt generator. Use or discard remaining cubes prior to disconnecting power source.

### Controls

The only user accessible control on this ice maker is the power switch located behind the front grill of the ice maker. If any other adjustments are needed, consult your Winnebago or Itasca dealer.

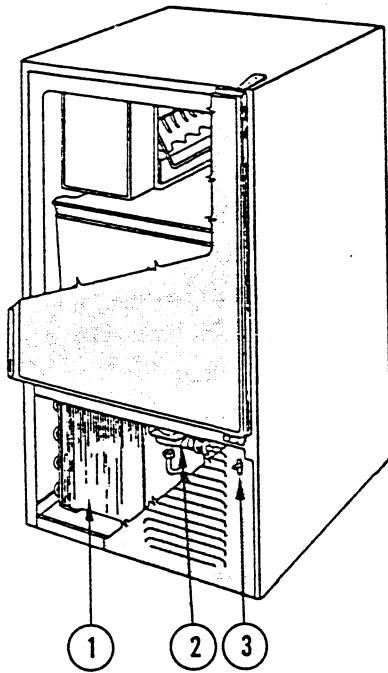

1. Condenser
2. Water Inlet Valve
3. Power Switch

### Maintenance

Once a year, remove the large brass nut on the water inlet valve, located behind the front grill of the ice maker, and use a toothbrush to remove sediment from the inlet screen. Sediments and impurities could restrict or block water flow and impair performance of the ice maker. If any other maintenance is required, your Winnebago or Itasca dealer has trained technicians to service your ice maker.

### Cleaning

The exterior may be cleaned with any mild, non-abrasive household cleaner. The interior should be cleaned with a mild soap and water solution. Avoid solvents, abrasives and all cleaners which might transfer taste to the ice cubes.

The condenser should be cleaned frequently to provide proper cooling. Lift the front grill and vacuum the condenser coils.

### Care of Aluminum Wheels - Optional (Elandan & Windcruiser)

If your aluminum wheels should become dull or discolored by road film, use any commercially available designated aluminum wheel cleaner/polish to restore the bright finish. The manufacturer of the wheels suggests monthly cleaning during constant daily use and less frequently with decreasing use.

### WHEEL NUTS - Optional Aluminum Wheels (Elandan & Windcruiser)

#### WARNING

Do not use wheel nuts intended for aluminum wheels to mount the steel wheel spare tire. These nuts will not seat properly on steel wheels. Use only the wheel nuts and steel trim ring provided with the spare tire for mounting. Refer to pg. 112 for additional information.

## INSTRUMENT PANEL (Elandan & Windcruiser)

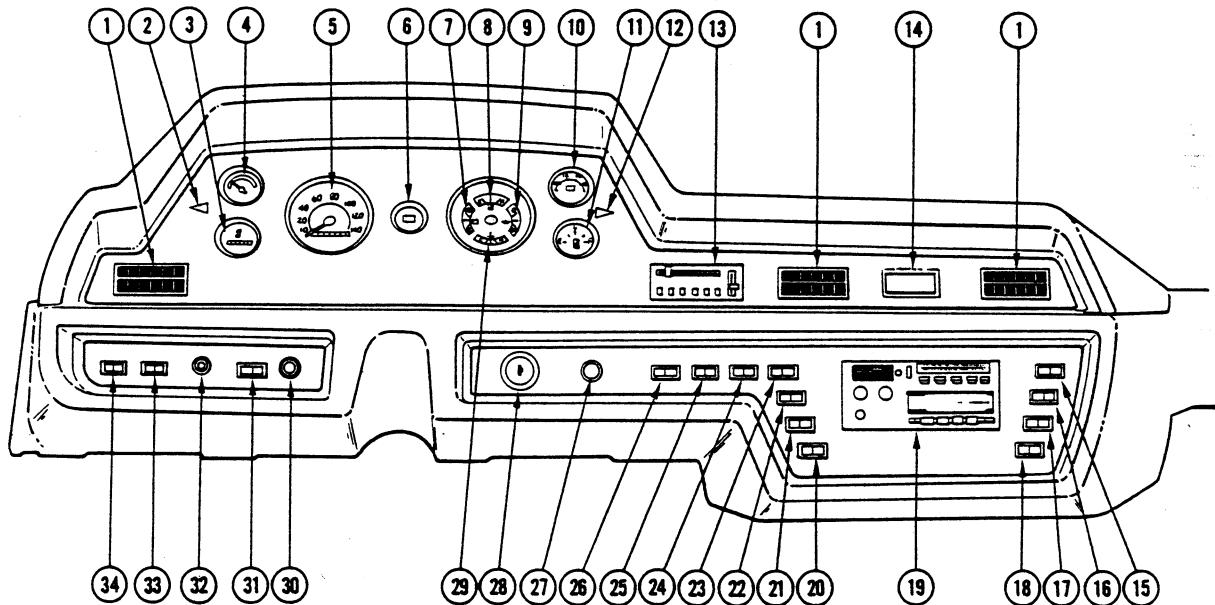

- |   |                                       |
|---|---------------------------------------|
| 1. Vent                                     | 18. Beverage Tray Light Switch        |
| 2. Left Turn Indicator                      | 19. Radio/Cassette Player             |
| 3. Hourmeter (Opt.)                         | 20. Thermometer Display Switch        |
| 4. Vacuum Gauge                             | 21. Exterior Compartment Light Switch |
| 5. Speedometer                              | 22. Auxiliary Fan Switch (Opt.)       |
| 6. Brake Warning Light                      | 23. Electric Generator Switch (Opt.)  |
| 7. Ammeter                                  | 24. Fuel Tank Selector Switch (Opt.)  |
| 8. Fuel Gauge                               | 25. Battery Mode Switch               |
| 9. Oil Pressure Gauge                       | 26. Battery Condition Switch          |
| 10. Voltmeter                               | 27. Cigarette Lighter                 |
| 11. Auxiliary Fuel Gauge                    | 28. Ignition Switch                   |
| 12. Right Turn Indicator                    | 29. Temperature Gauge                 |
| 13. Air Cond./Heater Controls (A.C. - Opt.) | 30. Switch - Panel/Headlights         |
| 14. Digital Thermometer                     | 31. ICC Courtesy Blink Switch         |
| 15. Courtesy Light Switch                   | 32. Wiper Delay Control               |
| 16. Aisle Light Switch                      | 33. Windshield Washer Switch          |
| 17. Map Light Switch                        | 34. Windshield Wiper Switch           |

## **INSTRUMENTS AND CONTROLS (Elandan & Windcruiser)**

### **Digital Thermometer**

The thermometer will display either interior or exterior temperature in degrees Fahrenheit as selected with the switch on the instrument panel.

### **Temperature Display Switch**

The thermometer display is off while the switch is in the neutral position. Rock the switch to the left to display interior temperature and to the right to display outside temperature.

### **Map Light Switch**

A switch on the instrument panel controls the map light located between sunvisors overhead of the driver's compartment.

### **Beverage Tray Light Switch**

The beverage tray on the engine cover contains a small light for nighttime convenience. The switch for this light is located on the instrument panel to the right of the radio/cassette player.

### **Courtesy Lights Switch**

The courtesy lights are located near the floor of the driver's compartment ahead of the cab doors and illuminate when the cab doors are open. The switch, located on the instrument panel, allows you to turn the courtesy lights on while the doors are closed.

### **Exterior Compartment Light Switch**

This is the master switch for the exterior storage compartment lights. The lights are individually activated at each door while this switch is on. Remember to shut switch off when not in use to prevent accidental battery discharge if a compartment switch is inadvertently left on.

### **Auxiliary Fan Switch - Optional**

If your vehicle is equipped with the optional auxiliary defrost fans, the switch is located on the instrument panel to the left of the radio/-cassette player.

### **Aisle Light Switch**

The aisle lights are mounted near the floor in various locations throughout the motor home to illuminate walkways. The power switch is located on the instrument panel. A control switch is located on a cabinet side near the entrance. The control switch functions only while the power switch is on.

### **ICC Courtesy Blink Switch**

This switch may be used to momentarily blink clearance lights off and on when meeting another Winnebago/Itasca owner or anyone else you wish to greet in this manner. This function is also helpful in signaling to truckers when they may safely pull back into the lane after passing you. To use, press the right side of the switch momentarily and release. This switch will operate only while the headlight switch is in either the "Park" or "Headlight" position.

## **ENGINE COVER (Elandan & Windcruiser)**

The carpeted engine cover, located in the driver's compartment, may be removed by removing the four (4) bolts securing it to the floor and lifting it off.

## **ENGINE ACCESS (Elandan & Windcruiser)**

The hood release knob is located on the steering column bracket near the bottom of the dash. To open, pull out on the knob and the hood will unlock. Lift up the hood and support it with the hood prop rod.

With the hood open, the oil dipstick, oil fill, radiator fill, windshield washer reservoir and automotive (starting) battery are accessible.

**ENGINE ACCESS  
(Elandan & Windcruiser) -  
Chevrolet Chassis**

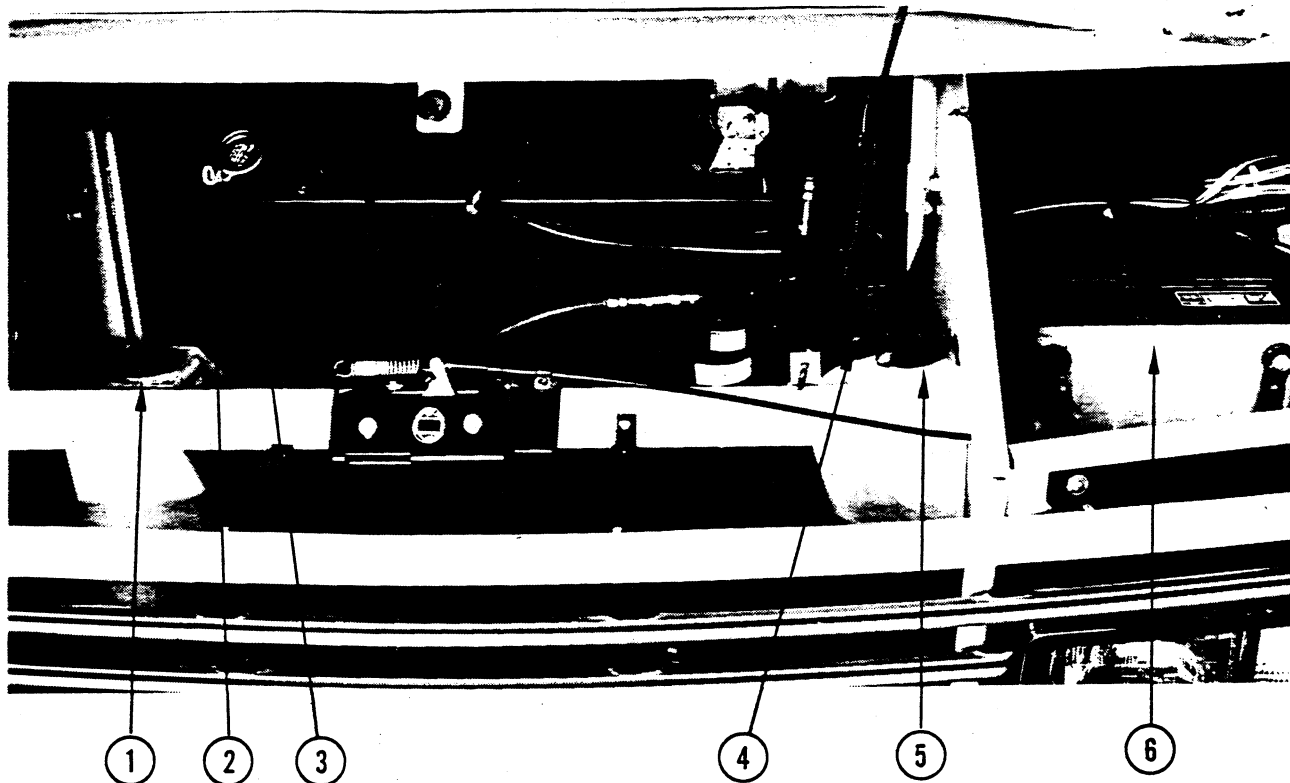

1. Radiator Coolant Fill
2. Engine Oil Dipstick
3. Engine Oil Fill
4. Power Steering Fluid Fill/Dipstick
5. Windshield Washer Fluid Fill
6. Automotive Battery

**WATER SYSTEM DRAIN VALVE LOCATIONS**

Model	Locations
ICP28RU	Beneath rear bed; beneath shower; beneath galley cabinet shelf
WCP31RT ICP31RT	Beneath rear bed; beneath shower; beneath ice maker cabinet (optional)
WCP34RU ICP34RU	Beneath rear bed; beneath shower; beneath ice maker cabinet (optional)

Refer to pg. 103-105 for additional information.

## SPECIFICATIONS - WINNEBAGO AND ITASCA MODELS: ICP28RU, WCP31RT, ICP31RT, W/ICP34RU

These specifications were accurate at the time of printing. We reserve the right to change specifications or design without notice and without incurring obligation to install the same on products previously manufactured.

	ICP28RU	WCP31RT	ICP31RT	W/ICP34RU
Width - Body	95.75"	95.75"	95.75"	95.75"
Width - Bumper (Front)	90"	90"	90"	90"
Width - Bumper (Rear)	94.5"	94.5"	94.5"	94.5"
Height - w/o Roof Air	9'4.25"	9'4"	9'4"	<sup>3</sup>
Height - w/Roof Air	10'7.75"	9'11.5"	9'11.5"	<sup>3</sup>
Length - Bumper to Bumper	29'6"	31'9.5"	31'9.5"	<sup>3</sup>
Approximate Dry Weight	10,352 lbs.	10,445 lbs.	10,445 lbs.	<sup>3</sup>
Approximate Wet Weight	10,712 lbs.	11,565 lbs.	11,565 lbs.	<sup>3</sup>
Interior Height	76.25"	76.25"	76.25"	76.25"
Interior Width (Widest Point)	91"	91"	91"	91"
Water System Capacity - w/o Water Heater (Approx.)	49 gal.	54 gal.	54 gal.	54 gal.
Water Heater Capacity	6 gal.	6 gal.	6 gal.	6 gal.
Holding Tank Capacity - Sewage (Approx.)	40 gal.	40 gal.	40 gal.	40 gal.
Holding Tank Capacity - Waste Water (Approx.)	40 gal.	44 gal.	44 gal.	40 gal.
LP Gas Capacity - Standard	80 lbs.	80 lbs.	80 lbs.	80 lbs.
LP Gas Capacity - Optional	NA	NA	NA	NA
Sleeping Capacity - Standard	4	4	4	5
Sleeping Capacity - Maximum	5 <sup>1</sup>	6 <sup>1</sup>	6 <sup>1</sup>	6 <sup>1</sup>
Chassis Manufacturer	Chevrolet	Chevrolet	Chevrolet	Chevrolet
Model	CP31832	CP31832	CP31832	CP31832
Wheelbase	178"	190"	190"	208"
Axle Ratio	4:56	4:56	4:56	4:56
GVWR	14,500 lbs.	14,500 lbs.	14,500 lbs.	14,500 lbs.
GAWR - Front	5,000 lbs.	5,000 lbs.	5,000 lbs.	5,000 lbs.
GAWR - Rear	9,840 lbs.	9,840 lbs.	9,840 lbs.	9,840 lbs.
Engine	454 C.I.D.	454 C.I.D.	454 C.I.D.	454 C.I.D.
Optional Engine	NA	NA	NA	NA
Fuel Tank Capacity (Approx.)	60 gal.	60 gal.	60 gal.	60 gal.
Hitch Capacity - Ball	200 lbs.	200 lbs.	200 lbs.	200 lbs.
Hitch Capacity - Towed Vehicle	2,000 lbs.	2,000 lbs.	2,000 lbs.	2,000 lbs.
Roof Load	100 lbs.	100 lbs.	100 lbs.	100 lbs.
Total Roof, Hitch and Rear Bumper Weight	250 lbs.	250 lbs.	250 lbs.	250 lbs.
Fuel Tank Capacity - Auxiliary (Approx.)	NA	30 gal.	30 gal.	30 gal.

<sup>1</sup>Depends optional floor plan configuration.

<sup>2</sup>Not available with 6.2L Diesel option.

<sup>3</sup>Specifications not available at time of publication.

<sup>4</sup>4:56 axle with 6.2L Diesel option.

<sup>5</sup>Availability subject to change.

NA - Not available





## TABLE OF CONTENTS

INTRODUCTION .....	1-3	Coolant System Warnings .....	20
Winnebago and Itasca Traveler's Clubs ...	1	Instrument Panel Diagrams .....	21-25
LIMITED WARRANTY .....	1-3	RADIOS .....	26-32
Warranty Period .....	1	Hi-Comp AM/FM Cassette Stereo	
Implied Warranties .....	2	(Electronic Tune) .....	26-28
Winnebago's Responsibility .....	2	Hi-Comp AM/FM Cassette Stereo	
Care and Maintenance .....	2	(Manual Tune) .....	28,29
Contacting Winnebago Owner Relations		AM/FM Cassette Stereo .....	29,30
Department .....	2,3	AM/FM Cassette Stereo	
SAFETY PRECAUTIONS .....	4,5	w/Equalizer .....	31,32
LP Gas Warning .....	5	SEAT AND DOOR PANEL	
Formaldehyde Warning .....	5	CONTROLS .....	33-36
SPECIFICATIONS .....	6-9	Entrance Door Lock .....	33
Chassis Manufacturer's Owner's and		Entrance Door Handle .....	33
Driver's Manual .....	6	Driver Compartment Door Lock .....	33
Individual Model Specifications		Seats .....	33,34
Charts .....	7-9	Square Back Bucket Seat Youth Bed .....	34
INSTRUMENTS AND CONTROLS ....	10-14	Seat Assembly Arm Rest Adjustment .....	34
Ignition Switch .....	10	Seat Belts .....	34,35
Ignition Keys .....	10	Shoulder Belts .....	35
Power Steering .....	10	Child Restraint System .....	35,36
Tilt Steering Wheel .....	10	TRAVELING WITH YOUR MOTOR	
Turn Signals .....	10,11	HOME .....	37-41
Hazard Warning Flasher .....	11	Pre-Travel Checklist .....	37
Cruise Control .....	11,12	Carbon Monoxide Warning .....	37
Power Brakes .....	12,13	Equipping for Travel .....	37,38
Automatic Brake Adjustment .....	13	Emergency Equipment Checklist .....	38
Parking Brake .....	13	Quick Loading Checklist .....	38
High Beam Switch and Indicator		Emergency Exit Window .....	38,39
Light .....	13,14	Use of Slider Windows as Emergency	
Automatic Transmission .....	14	Exits .....	39
INSTRUMENT PANEL .....	15-25	Loading the Motor Home .....	39
Headlight Switch .....	15	Weighing the Motor Home .....	39,40
Windshield Washer and Wiper .....	15,16	Roof Loading .....	40
Heater and Air Conditioner		Trailer Towing .....	40,41
Controls .....	16,17	DRIVING TECHNIQUES .....	42-45
Battery Condition Meter and		Filling Fuel Tanks .....	42
Switch .....	17,18	Water in Fuel Information - Diesel	
Auxiliary Generator Switch .....	18	Engines .....	42
Auxiliary Generator Hourmeter .....	18	Travel Tips .....	42,43
Brake Warning Light .....	18	Winter Camping Tips .....	43,44
Speedometer .....	18	Fire, Extinguisher .....	44
Cigarette Lighter .....	18	Flash Flood and Severe Weather	
Clock .....	18	Safety .....	44,45
Oil Pressure Gauge .....	18	Night Time Driving .....	45
Temperature Gauge .....	18,19	Mountain Driving .....	45
Fuel Gauge .....	19	DUAL FUEL SYSTEM .....	46-50
Fuel Tank Selector Switch .....	19	Principal of Operation .....	46
Alternator Indicator .....	19	Bulk Fuel Tank .....	46
Vacuum Fuel Economy Gauge .....	19,20	Filling the Bulk LP Tank .....	46,47
Dual Battery Switch .....	20	Operation Instructions .....	47,48
"Glow Plugs On" Indicator Light .....	20	Starting Instructions .....	48
"Water in Fuel" Indicator Light .....	20	Cold Weather Operation .....	48,49
"Low Coolant" Warning Light .....	20	Maintenance .....	49,50



Engine Break-In Period .....	49	External Water Supply .....	68
LP Gas Fuel System .....	49	City Water Connection .....	68
Storage .....	49	<b>DRAINAGE SYSTEM .....</b>	<b>69-72</b>
Fuel Filter .....	49	Dumping Holding Tanks .....	69
Engine Oil and Oil Filter .....	49,50	Use of In-Park Sewer System .....	69
Checking Engine Oil .....	50	Fresh Water Toilet (Model SL) .....	69,70
Air Cleaner .....	50	Toilet Operation .....	70
Cooling System .....	50	Toilet Maintenance .....	70
<b>ELECTRICAL SYSTEM .....</b>	<b>51-61</b>	Toilet Troubleshooting .....	70
12 Volt DC System .....	51	Fresh Water Toilet (Aqua Magic IV) .....	71
110 Volt AC System .....	51	Toilet Operation .....	71
External Utility Supply .....	51	Toilet Maintenance .....	71
Power Control Center .....	51-53	Toilet Troubleshooting .....	71
Ground Fault Interrupter .....	53	Waste Distribution Chart .....	72
Battery Access .....	53,54	<b>EQUIPMENT AND APPLIANCES .....</b>	<b>73-96</b>
Battery Maintenance .....	54	Gas Furnace .....	73-75
Emergency Starting .....	54,55	Range and Oven .....	75-77
Dual Battery Switch .....	55	Non-Powered Range Hood .....	77
Battery Isolator .....	55	Microwave Oven .....	77,78
Auxiliary 110 Volt Generator .....	55-61	Refrigerator - Manual Ignition .....	78-82
Exhaust Spark Arrester .....	56	Refrigerator - Electronic Ignition .....	83,84
Preparation for Use - 110 Volt		Refrigerator - Electronic Ignition with	
Generator .....	56	Mode Selector .....	85-87
Generator Operation Cautions .....	56,57	Refrigerator Door Lock .....	87
Hourmeter .....	57	Defrosting the Refrigerator .....	87
Overload Circuit Breakers .....	57	Cleaning the Refrigerator .....	87
Onan Generators - Operation and		Water Heater .....	87-89
Maintenance .....	57,58	Pilot Ignition Water Heater .....	87-89
Kohler Generator - Gas Powered Vehicles -		Electronic Ignition Water Heater .....	89
Operation .....	59-60	Motor Aid Water Heater .....	89
Kohler Generator - Diesel Powered		Auxiliary Rear Automotive Heater .....	89
Vehicles - Operation .....	60	Vacuum Cleaner .....	90
Generator Storage Procedures .....	60,61	Roof Air Conditioner .....	90-92
Recommended Oil Viscosity Chart .....	61	Air Conditioner Selector Switch .....	92
Generator Service Schedules .....	61	T.V. Antenna .....	92,93
<b>LP GAS SYSTEM .....</b>	<b>62-65</b>	Monitor Control Panels .....	93-96
LP Gas Supply .....	62	<b>INTERIOR FURNISHINGS .....</b>	<b>97,98</b>
Trouble-Free and Safe Use of the LP Gas		Front Pull Down Bunk .....	97
System .....	62	Dinette/Bed .....	97
Bulk Tank System .....	62,63	Overhead Bunk .....	97
Travel with LP Gas .....	63	Side Pull Down Bunk .....	97
Regulator Freeze-up .....	63,64	Slide-Out Couch .....	97
Leak Detector .....	64	Convertible Couch .....	98
Winter Use of LP Gas .....	65	Pedestal Dinette Table .....	98
Procedures to Follow in the Event of an		Fold-Up Table .....	98
LP Gas Leak .....	65	<b>MOTOR HOME CARE AND</b>	
<b>WATER SYSTEM .....</b>	<b>66-68</b>	<b>MAINTENANCE .....</b>	<b>99-102</b>
Internal Water System .....	66,67	Roof .....	99
Filling Procedures .....	66	Underbody .....	99
Water Pump .....	66	Exterior .....	99
Initial Start Up .....	66	Upholstery and Carpeting .....	99,100
Demand Water Pump - Maintenance .....	66	Fabric Draperies .....	100
Water Pump Location .....	66	Woven Wood Draperies .....	100
Water Filter .....	67	Work Surfaces .....	100
Troubleshooting Demand Pump .....	67	Stainless Steel Sink .....	100
Sanitizing the Potable Water System .....	68	Walls and Ceiling .....	100



Range and Refrigerator .....	100
Bathroom .....	100,101
Doors and Windows .....	101
Body Maintenance Checklist .....	101,102
<b>STORAGE</b> .....	103-105
Winterizing .....	103,104
Removal from Storage and New Season Preparation .....	104,105
Water System Drain Valve Location Chart .....	105
<b>VEHICLE MAINTENANCE</b> .....	106-113
Engine Access .....	106
Brake Fluid Reservoir .....	106
Checking Engine Oil Level .....	106
Brake Master Cylinder .....	106
Engine Cooling System .....	106,107

Tires .....	107
Tire Rotation .....	107
Engine Access .....	108
Tire/Wheel Load and Inflation Pressure Chart .....	109
Windshield Washers and Wipers .....	110
Lights .....	110
Fuses .....	110
Motor Home Jacking and Tire Change Procedure .....	110-113
Towing Safety Precautions .....	113
<b>IMPORTANT SERIAL NUMBERS</b> ....	inside back cover
<b>EMERGENCY INFORMATION</b> .....	inside back cover



# INTRODUCTION

Congratulations on the purchase of your new motor home which has been carefully designed, engineered and quality built by Winnebago Industries, Inc., the company that founded the motor home industry.

Driving a motor home requires a somewhat different driving technique than when driving an automobile. Your motor home has been equipped with such standard features as power steering and power brakes to make it handle similar to an automobile. When driving your motor home, always remember that the weight, length, width and height are greater than an automobile. Your motor home requires greater stopping distance, more parking space, more maneuvering space and more acceleration time when passing other vehicles than an automobile does.

This manual was constructed with the owner in mind. It is intended to provide you with the information needed to properly and safely operate and maintain your new motor home. It contains all of the warranty information which applies to your vehicle. It also contains tips and information that will aid in the overall enjoyment of your motor home, whether traveling or camping.

Before entering the drivers seat, always check around your vehicle in all directions to assure that you have proper clearance in order to avoid minor accidents. When backing up, be positive there is nothing behind your vehicle. As an extra precaution, have a passenger check the area around your vehicle as you maneuver out of a difficult parking space.

Always be aware of the dimensions of your motor home, which are listed in the specifications section of this manual. Tunnels, low hanging canopies and signs in service stations and restaurants can cause clearance problems. Keep in mind the added height of any options on the roof such as air conditioner units, TV antennas or luggage boxes. Also, remember that some old bridges may not accept the weight of your motor home.

When planning a trip to another state, write ahead for a booklet detailing the laws for the state. Some states have specific laws pertaining to recreational vehicles.

With safety in mind, always use your seat belt and instruct your passengers to do so as well. Frequent rest stops are advised to relieve stress on the driver, passengers and the vehicle.

After reading this manual, be sure to keep it in your motor home at all times, as the information it contains will be necessary for service and/or

warranty repairs and for your personal reference. Your dealer will be glad to provide any additional information you feel you need, as well as answer any questions you might have about operating the equipment in your motor home. When it comes to service, remember that your dealer knows your vehicle best and is interested in your satisfaction. Your dealer will provide quality maintenance and any other assistance that you may require during your ownership of the vehicle.

**NOTE:** The description, illustrations and specifications in this manual were correct at the time of printing. We reserve the right to change specifications or design without notice and without incurring obligation to install the same on products previously manufactured.

Since Winnebago and Itasca motor homes are built in several models and sizes, some accessories and components may be standard or optional on some models. Therefore, some equipment described in this manual may not apply to your vehicle.

## Winnebago International Travelers Club Itasca Travelers Club

If you have not received information within 30 days after purchasing your motor home, please write either W.I.T. or I.T.C., Winnebago Industries, Inc., Forest City, Iowa 50436, Attention: W.I.T. or I.T.C.

## WARRANTY COVERAGE TO OWNER

- A. **Warranty Coverage - Winnebago Industries, Inc. of Forest City, Iowa warrants each new Winnebago and Itasca motor home to the owner as follows:**

**This warranty shall not apply to failures due to normal wear, accident, misuse, abuse or negligence.**

## WARRANTY PERIOD

For the period of one year or 12,000 miles, (20,000 kilometers) of use, whichever occurs first, from date the vehicle is delivered to the first retail purchaser or first placed in service as a demonstrator or company vehicle, whichever is earlier.

**ITEMS NOT COVERED BY WINNEBAGO IND., INC. WILL BE COVERED UNDER MANUFACTURERS INDIVIDUAL WARRANTIES**

- Chassis
- Microwave
- Radio
- Tires
- Auxiliary Battery
- Service Items
- Fuses
- Interior and Exterior Light Bulbs
- Headlight Seal Beams
- Windshield Wiper Blades
- Oil or Air Filters
- Oil or Lubricants
- Vacuum Cleaner Bags

**IMPLIED WARRANTIES**

In addition, each new Winnebago and Itasca motor home shall be subject to warranties implied by law including the implied warranties of merchantability and fitness for any particular purpose but such implied warranties are limited to the owner for the period of one year or 12,000 miles of use, whichever occurs first, from date the vehicle is delivered to the first retail purchaser or placed in service as a demonstrator or company vehicle, whichever is earlier. Some states do not allow limitations on how long an implied warranty lasts, so the above limitation may not apply to you.

**WINNEBAGO'S RESPONSIBILITY**

B. Any part of the motor home subject to this warranty which is found to be defective in material or workmanship, will be repaired or replaced at Winnebago Industries' option, within thirty (30) days of notice of defect by the selling dealer without charge to the customer for parts or labor. If the owner of the motor home has moved to a different locality and cannot return to the selling dealer, the owner may obtain warranty repairs or replacement of such items at any authorized Winnebago or Itasca dealership. If the owner of the motor home is traveling and is in excess of 100 miles from the selling dealer, or if the selling dealer has ceased to do business as an authorized Winnebago dealer, the owner may obtain warranty repairs or replacement of such items at any authorized Winnebago Industries, Inc. (Itasca or Winnebago brands) dealership.

**CARE AND MAINTENANCE**

Under this warranty the owner must perform the care and maintenance duties discussed in the Owner's Manual which accompanies your motor home. Any damage which results to your motor home as a result of your failure to perform such duties, will not be covered by this warranty. The care and maintenance duties described in the Owner's Manual will be done at your expense.

The servicing dealer will perform any adjustment service required as the result of a manufacturing deficiency during the first 90 days of warranty coverage. Thereafter, adjustments will be considered owner maintenance responsibility.

**INSTALLATION NOT COVERED**

Winnebago Industries, Inc., cannot, however, and does not accept any responsibility in connection with any of its motor homes for additional equipment or accessories installed at any dealership or other place of business, or by any other party other than Winnebago Industries, Inc. Such installation of equipment or accessories by any other party will not be covered by the terms of this warranty.

**IF REPAIRS ARE NEEDED**

- C. If a part of the system covered by this warranty fails to function or requires service during the warranty period:
1. Take the motor home to the selling dealer or other authorized Itasca or Winnebago dealer, as specified in section B of this warranty, for repair.
  2. If the dealer is incapable of making the repair, request that he contact Winnebago Industries, Inc., Owner Relations Department, for technical or parts assistance.

**CUSTOMER RESPONSIBILITY**

3. If, after the above steps are completed and the repair is not made, the customer should contact Winnebago Industries, Inc., P.O. Box 152, Forest City, Iowa 50436. Attention: Owner Relations Department, and furnish the following information:

**CONTACTING WINNEBAGO OWNER RELATIONS DEPT.**

- The complete serial number of the motor home



- Date of retail purchase
- Selling dealer's name
- Nature of the service problem, and a brief explanation of the steps or service the dealer has performed, and the results obtained. The customer may be directed to another dealer or service center for repairs to be completed, if such dealer or service center is better able to complete the repair.

4. If all attempts to repair the motor home at the dealer level fail to accomplish the repair, Winnebago Industries may request that the motor home be allowed to be brought back to Winnebago Industries, Inc., Customer Service Department at Forest City, Iowa, at Winnebago Industries expense, to complete the repairs. In such event, Winnebago Industries, Inc., shall be allowed an additional thirty (30) days to perform its obligations under this warranty.

If the customer refuses to allow the motor home to be brought back to Winnebago Industries, Inc., for such repairs, or refuses to go to the designated service center or dealer for repairs, the warranty on that repair will be voided.

5. If after the above steps are completed and the repairs are not completed, the customer can:
  - Contact the Director of Parts and Service of Winnebago Industries and request a customer relations board meeting to resolve the problem. This action, however, is not mandatory.

- This warranty gives you specific legal rights, and you may also have other rights which vary from state to state. In the event of a problem with warranty service or performance, you may be able to go to a small claims court, a state court, or a federal district court.

## **DEALER REPRESENTATION EXCLUDED**

- D. Winnebago Industries, Inc., does not undertake responsibility to any purchaser of its products for any undertaking, representation or warranty made by dealers selling its products beyond those herein expressed.

## **CONSEQUENTIAL DAMAGES**

Without regard to the alleged defect, Winnebago Industries, Inc., under any circumstances, does not assume any responsibility for loss of time, inconvenience, or other consequential damage including expense for gasoline, telephone, travel, lodging, loss or damage to personal property, or loss of revenue. Some states do not allow the exclusion or limitation of incidental or consequential damages, so the above limitation or exclusion may not apply to you.

## **CHANGES IN DESIGN**

Winnebago Industries, Inc., reserves the right to make changes in design and changes or improvements upon its products without imposing any obligation upon itself to install the same upon its products theretofore manufactured.

# SAFETY PRECAUTIONS

Read and understand all instructions and precautions in this manual before operating your new motor home. The symbol WARNING is used throughout the manual to alert you to precautions that involve your safety. Read and follow them carefully. Listed are some safety precautions that must be adhered to. These precautions as well as others that involve damage to equipment are also listed in the appropriate areas in this manual.

- Sleeping facilities are not to be utilized while vehicle is in motion.
- Never allow a passenger to stand or kneel on the seats when the vehicle is in motion.
- Make sure all passengers have seat belts fastened in a low and snug position so the force exerted by the belt in a collision will be spread across the strong hip area.
- Do not attempt to adjust the driver's seat while the vehicle is in motion.
- Do not adjust tilt steering in a moving vehicle
- Do not operate speed control on icy roads.
- Avoid inhaling exhaust gases. They contain carbon monoxide, which by itself is odorless, colorless and poisonous.
- Use care when accelerating or downshifting on a slippery surface. Abrupt speed changes can cause skidding and loss of control.
- Do not alter the LP gas system at any time or in any way.
- Never use an open flame to test for LP gas leaks. Replace all protective covers and caps on LP system after filling.
- When lighting range burners do not turn burner controls to "On" and allow gas to escape before lighting match.
- Avoid inhaling exhaust gases produced by burned gasoline, diesel fuel or LP gas in items such as the range, chassis engine, generator engine, refrigerator, furnace and hot water heater.
- Be aware of the GVWR, GAWR and individual load limit on each tire or set of duals. See "Loading the Motor Home", page 39.
- Do not fill LP container(s) to more than 80 percent of capacity. Overfilling the LP gas container can result in uncontrolled gas flow which can cause fire or explosion. A properly filled container will contain approximately 80 percent of its volume as liquid LP gas.
- All pilot lights and appliances must be turned off while refilling the fuel tank or LP tank.
- Never load the motor home in excess of the gross vehicle weight rating or the gross axle weight rating for either axle.
- Do not remove radiator cap while engine and radiator are still hot. Always check coolant level visually at the see-through coolant reservoir.
- Never get beneath a vehicle that is held up by the jack only.
- Do not mix different construction types of tires on the vehicle such as radial, bias or belted tires, as vehicle handling may be affected. Replace tires with exact size, type and load range.
- Examine the escape window and be familiar with its operation, but do not use except in an emergency.
- Do not attempt to start the vehicle by hot wiring.
- Never carry extra fuel inside the motor home.
- Driving through water deep enough to wet the brakes may affect stopping distance or cause the vehicle to pull to one side. Check brake operation in a safe area to be sure they have not been affected. Never operate any vehicle if a difference in braking efficiency is noticeable.
- Only seats equipped with seat belts are to be occupied while the vehicle is in motion.
- Monthly, and before beginning a vacation or extended trip, check the fire extinguisher for proper charge and inspect to assure proper operating conditions.
- LP gas containers shall not be placed or stored inside the vehicle. LP gas containers are equipped with safety devices which relieve excessive pressure by discharging gas to the atmosphere.

- It is not safe to use cooking appliances for comfort heating. Cooking appliances need fresh air for safe operation. Before operation:

1. Open overhead vent or turn on exhaust fan, and
2. Open window.

This warning label has been located in the cooking area to remind you to provide an adequate supply of fresh air for combustion. Unlike homes, the amount of oxygen supply is limited due to the size of the recreational vehicle, and proper ventilation when using the cooking appliance(s) will avoid dangers of asphyxiation. It is especially important that cooking appliances not be used for comfort heating as the danger of asphyxiation is greater when the appliance is used for long periods of time.

- Portable fuel-burning equipment, including wood and charcoal grills and stoves, shall not be used inside the recreational vehicle. The use of this equipment inside the recreational vehicle may cause fires or asphyxiation.
- Do not bring or store LP gas containers, gasoline or other flammable liquids inside the vehicle because a fire or explosion may result.
- Never connect natural gas to the LP gas system.
- LP gas regulators must always be installed with the diaphragm vent facing downward. Regulators that are not in compartments have been equipped with a protective cover. Make sure that regulator vent faces downward and that cover is kept in place to minimize vent blockage which could result in excessive gas pressure causing fire or explosion.
- The following label has been placed in the vehicle near the range area:

#### **IF YOU SMELL GAS:**

1. Extinguish any open flames, pilot lights and all smoking materials.
2. Do not touch electrical switches.
3. Shut off the gas supply at the tank valve(s) or gas supply connection.
4. Open doors and other ventilating openings.
5. Leave the area until odor clears.
6. Have the gas system checked and leakage source corrected before using again.

#### **FORMALDEHYDE WARNING**

### **WARNING**

Some components in this vehicle contain formaldehyde based adhesives which may release formaldehyde fumes into the air for an unknown period of time until total dissipation occurs. Individuals who are allergic to formaldehyde gas fumes may experience irritation to eyes, ears, nose and throat. Reaction in infants may be more severe. Although long range effects are not well understood, testing to date has not revealed any serious health effects in humans at the level of emission from these products.

#### **IMPORTANT**

To aid in dissipation, ventilate the vehicle by opening all windows and circulating the air with a fan. Do not occupy the vehicle if you notice a sensitivity to the formaldehyde fumes. Check small infants and children for reactions to fumes.

For further information or assistance in proper dissipation or fumigation of formaldehyde fumes, contact your dealer.

# SPECIFICATIONS

All specifications in this manual were accurate at the time of printing. We reserve the right to change specifications or design without notice and without incurring obligation to install the same on products previously manufactured.

## Chassis:

Specifications and information pertaining to the vehicle engine, chassis and operating procedures are contained in the chassis manufacturer's Owner's and Driver's Manual. The following information is provided with your owner's package and should be kept available for ready reference. Since manufacturer's specifications are subject to change without notice, it is advised that you become familiar with the chassis specifications applicable to your particular model unit. To obtain the following information, see the Chevrolet Owner's and Driver's Manual which is provided with your motor home.

1. Engine and Chassis Specifications
2. Lubricant Capacities
3. Fuel Requirements
4. Starting the Engine - Gas and Diesel
5. Transmission Gear Selection
6. New Vehicle Break-In
7. Engine Oil Change Interval
8. Engine Oil Grades and Viscosity
9. Automatic Transmission Fluid Recommendations and Procedures
10. Brakes - Fluid Replacement
11. Power Steering Fluid Replacement
12. Vehicle Chassis Maintenance Schedules
13. Diesel Filtration and Fuel Systems

## Vehicle:

The frame and load carrying components of your vehicle have been designed to provide satisfactory service as long as the vehicle is not loaded in excess of the gross vehicle weight rating (GVWR) or the gross axle weight rating (GAWR) for the front and rear axles. These ratings are listed on the "Vehicle Certification" label, located on the drivers sidewall to the left of the dash on all A-body motor homes and on the cab body just above the left door striker on all C-body motor homes. Use this label for reference when loading the unit and then weigh the vehicle on scales to determine the actual weight. Since all weights listed in the motor home owner's manual are approximate only, it is recommended that the vehicle be weighed and the values recorded for future operational reference. The dry

weight of the vehicle is defined as the standard unit with no fluid or passengers. The wet weight of the vehicle is defined as the standard unit with fuel, water, LP gas full, the holding tanks empty and 800 lbs. total for four passengers and luggage. Refer to the paragraphs entitled, "Loading the Motor Home" and "Weighing the Motor Home", to assist in conforming to the Gross Vehicle Weight Ratio (GVWR) and the Gross Axle Weight Ratio (GAWR - Front, GAWR - Rear). It is recommended that the vehicle be weighed periodically to assure continued conformance to the gross vehicle weight requirements.

## Capacities:

The tank capacities are determined from physical dimensions and are approximate only. Refillable capacities, therefore, may differ slightly from model to model.

## Tires:

Your motor home has been equipped with the proper size and load range tires, conforming to the GVWR of the vehicle and offering optimum operating ease and efficiency. The tire size and load range may vary depending on your particular model. It is recommended that you consult your chassis owners manual to obtain the applicable tire size and load range requirements. This information is also displayed on the "Vehicle Certification" label, located on the drivers sidewall to the left of the dash on all A-body motor homes and on the cab body just above the left door striker on all C-body motor homes.

Use care when replacing tires to assure that replacement tires are of the same size and load range rating as those originally installed. To assure proper vehicle performance and tire longevity, maintain the proper tire load limit inflation pressure. Refer to the paragraph entitled "Tires", for additional tire care and use information.

**SPECIFICATIONS — WINNEBAGO AND ITASCA MODELS:  
WC420RG, IC420RG, WC723RB, WC424RC, IC424RC,  
WCN22RC, ICN22RC, WCN23RG and ICN23RG**

These specifications were accurate at the time of printing. We reserve the right to change specifications or design without notice and without incurring obligation to install the same on products previously manufactured.

	W/IC420RG	WC723RB	W/IC424RC	W/ICN22RC	W/ICN23RG
Width - Body	95.5"	91.3"	95"	94.75"	94.75"
Width - Bumper (Front)	92"	89"	92"	96"	96"
Height - w/o Roof Air	9'9"	106'6"	9'4"	9'5"	9'5"
Height - With Roof Air	10'3"	116.4"	9'11 1/2"	10'1"	10'1"
Length - Bumper to Bumper	20'10"	22'1"	23'3"	22'6"	23'9 1/4"
Approximate Dry Weight	6,962 lbs.	5,850 lbs.	7,290 lbs.	7,665 lbs.	8,004 lbs.
Approximate Wet Weight	7,485 lbs.	6,350 lbs.	7,913 lbs.	8,390 lbs.	8,674 lbs.
Interior Height	80"	75"	77"	77"	77"
Interior Width (Widest Point)	91.5"	88"	91.25"	91"	91"
Water System Capacity (Approx.) (w/o Water Heater)	22 gal.	20 gal.	40 gal.	47 gal.	36 gal.
Holding Tank Capacity - Sewage (Approx.)	12 gal.	20 gal.	35 gal.	32 gal.	40 gal.
Holding Tank Capacity - Waste Water (Approx.)	12 gal.	N/A	35 gal.	25 gal.	20 gal.
LP Gas Capacity - Standard	42 lbs.	42 lbs.	42 lbs.	42 lbs.	42 lbs.
LP Gas Capacity - Optional	N/A	80 lbs.	80 lbs.	80 lbs.	80 lbs.
Water Heater Capacity	6 gal.	6 gal.	6 gal.	6 gal.	6 gal.
Sleeping Capacity - Standard	5	4	5	3	3
Sleeping Capacity - Maximum	6 <sup>1</sup>	6 <sup>1</sup>	5 <sup>1</sup>	4 <sup>1</sup>	4 <sup>1</sup>
Chassis Manufacturer	Chevrolet	Chevrolet	Chevrolet	Chevrolet	Chevrolet
Model	CG31332	CP21042	CG31632	CP31132	CP31132
Wheelbase	125"	133"	146"	137"	137"
Axle Ratio	4:10	3:73	4:10	4:10 <sup>4</sup>	4:10 <sup>4</sup>
GVWR	10,200 lbs.	8,600 lbs.	10,500 lbs.	11,800 lbs.	11,800 lbs.
GAWR - Front	3,900 lbs.	3,600 lbs.	3,900 lbs.	4,300 lbs.	4,300 lbs.
GAWR - Rear	7,200 lbs.	5,360 lbs.	7,200 lbs.	7,500 lbs.	7,500 lbs.
Engine	350 C.I.D.	350 C.I.D.	350 C.I.D.	454 C.I.D.	454 C.I.D.
Optional Engine	6.2 L Diesel	N/A	6.2 L Diesel	6.2 L Diesel	6.2 L Diesel
Fuel Tank Capacity (Approx.) (Main)	33 gal.	40 gal.	33 gal.	40 gal.	40 gal.
Hitch Capacity - Ball	200 lbs.	200 lbs.	200 lbs.	200 lbs.	200 lbs.
Hitch Capacity - Towed Vehicle	2,000 lbs.	2,000 lbs.	2,000 lbs.	2,000 lbs.	2,000 lbs.
Roof Load	100 lbs.	0	100 lbs.	100 lbs.	100 lbs.
Total Roof, Hitch and Rear Bumper Weight	250 lbs.	200 lbs.	200 lbs.	250 lbs.	250 lbs.
Fuel Tank Capacity (Auxiliary) (Approx.)	N/A	N/A	N/A	N/A	N/A

<sup>1</sup>Depends on optional floor plan configuration.

<sup>2</sup>Not available with 6.2 L Diesel option

<sup>3</sup>Specifications not available at time of publication.

<sup>4</sup>:56 axle with 6.2 L Diesel option.

<sup>5</sup>Availability subject to change.

## SPECIFICATIONS – WINNEBAGO AND ITASCA MODELS: WCN26RB, ICN26RB, WCN26RH, ICN26RH, and WCN27RU

These specifications were accurate at the time of printing. We reserve the right to change specifications or design without notice and without incurring obligation to install the same on products previously manufactured.

	WCN26RB	ICN26RB	WCN26RH	ICN26RH	WCN27RU
Width - Body	94.75	94.75"	94.75"	94.75"	94.75"
Width - Bumper	96"	96"	96"	96"	96"
Height - w/o Roof Air	9'4"	9'4"	9'4"	9'4"	9'4"
Height - With Roof Air	10'6"	10'6"	10'6"	10'6"	10'1/2"
Length - Bumper to Bumper	26'7"	26'7"	26'7"	26'7"	27'5"
Approximate Dry Weight	8,730 lbs.	8,815 lbs.	8,690 lbs.	8,775 lbs.	8,810 lbs.
Approximate Wet Weight	9,540 lbs.	9,625 lbs.	9,500 lbs.	9,585 lbs.	9,750 lbs.
Interior Height	77"	77"	77"	77"	77"
Interior Width (Widest Point)	91"	91"	91"	91"	91"
Water System Capacity (Approx.) (w/o Water Heater)	42 gal.	42 gal.	42 gal.	42 gal.	45 gal.
Holding Tank Capacity - Sewage (Approx.)	37 gal.	37 gal.	37 gal.	37 gal.	44 gal.
Holding Tank Capacity - Waste Water (Approx.)	33 gal.	33 gal.	33 gal.	33 gal.	37.9 gal.
LP Gas Capacity - Standard	42 lbs.	42 lbs.	42 lbs.	42 lbs.	42 lbs.
LP Gas Capacity - Optional	80 lbs.	80 lbs.	80 lbs.	80 lbs.	80 lbs.
Water Heater Capacity	6 gal.	6 gal.	6 gal.	6 gal.	6 gal.
Sleeping Capacity - Standard	3	3	5	5	4
Sleeping Capacity - Maximum	6 <sup>1</sup>	6 <sup>1</sup>	6 <sup>1</sup>	6 <sup>1</sup>	5 <sup>1</sup>
Chassis Manufacturer	Chevrolet	Chevrolet	Chevrolet	Chevrolet	Chevrolet
Model	CP31432	CP31432	CP31432	CP31432	CP31432
Wheelbase	158.5"	158.5"	158.5"	158.5"	158.5"
Axle Ratio	4:10 <sup>4</sup>	4:10 <sup>4</sup>	4:10 <sup>4</sup>	4:10 <sup>4</sup>	4:10 <sup>4</sup>
GVWR	12,300 lbs.	12,300 lbs.	12,300 lbs.	12,300 lbs.	12,300 lbs.
GAWR - Front	4,880 lbs.	4,880 lbs.	4,880 lbs.	4,880 lbs.	4,880 lbs.
GAWR - Rear	7,500 lbs.	7,500 lbs.	7,500 lbs.	7,500 lbs.	7,500 lbs.
Engine	454 C.I.D.	454 C.I.D.	454 C.I.D.	454 C.I.D.	454 C.I.D.
Optional Engine	6.2 L Diesel	6.2 L Diesel	6.2 L Diesel	6.2 L Diesel	6.2 L Diesel
Fuel Tank Capacity (Approx.)	60 gal.	60 gal.	60 gal.	60 gal.	60 gal.
Hitch Capacity - Ball	200 lbs.	200 lbs.	200 lbs.	200 lbs.	200 lbs. <sup>2</sup>
Hitch Capacity - Towed Vehicle	2,000 lbs.	2,000 lbs.	2,000 lbs.	2,000 lbs.	2,000 lbs. <sup>2</sup>
Roof Load	100 lbs.	100 lbs.	100 lbs.	100 lbs.	0
Total Roof, Hitch and Rear Bumper Weight	250 lbs.	250 lbs.	250 lbs.	250 lbs.	200 lbs. <sup>2</sup>
Fuel Tank Capacity (Auxiliary) (Approx.)	30 gals. <sup>5</sup>	30 gals. <sup>5</sup>	30 gals. <sup>5</sup>	30 gals. <sup>5</sup>	N/A

<sup>1</sup>Depends on optional floor plan configuration.

<sup>2</sup>Not available with 6.2 L Diesel option.

<sup>3</sup>Specifications not available at time of publication.

<sup>4</sup>4:56 axle with 6.2 L Diesel option.

<sup>5</sup>Availability subject to change.

## SPECIFICATIONS — WINNEBAGO AND ITASCA MODELS: ICN27RU, WCN30RT, ICN30RT, WCN30RC, WCN33RU, and ICN33RU

These specifications were accurate at the time of printing. We reserve the right to change specifications or design without notice and without incurring obligation to install the same on products previously manufactured.

	ICN27RU	WCN30RT	ICN30RT	WCN30RC	W/ICN33RU
Width - Body	94.75"	94.75"	94.75"	94.75"	94.75"
Width - Bumper	96"	96"	96"	96"	96"
Height - w/o Roof Air	9'4"	9'6 1/4"	9'6 1/4"	9'4 3/4"	9'5"
Height - With Roof Air	10'1/2"	10'1 1/4"	10'1 1/4"	10'1/4"	10'
Length - Bumper to Bumper	27'5"	29'11"	29'11"	30'1"	32'8"
Approximate Dry Weight	8,980 lbs.	9,820 lbs.	9,870 lbs.	9,985 lbs.	10,405 lbs.
Approximate Wet Weight	9,920 lbs.	10,940 lbs.	10,990 lbs.	10,960 lbs.	11,450 lbs.
Interior Height	77"	77.5"	77.5"	77.25"	77.25"
Interior Width (Widest Point)	91"	91"	91"	91"	91"
Water System Capacity (Approx.) (w/o Water Heater)	45 gal.	71 gal.	71 gal.	52 gal.	66 gal.
Holding Tank Capacity - Sewage (Approx.)	44 gal.	37.9 gal.	37.9 gal.	44 gal.	44 gal.
Holding Tank Capacity - Waste Water (Approx.)	37.9 gal.	30 gal.	30 gal.	42 gal.	37.9 gal.
LP Gas Capacity - Standard	80 lbs.	80 lbs.	80 lbs.	80 lbs.	80 lbs.
LP Gas Capacity - Optional	N/A	N/A	N/A	N/A	N/A
Water Heater Capacity	6 gal.	6 gal.	6 gal.	6 gal.	6 gal.
Sleeping Capacity - Standard	4	5	5	5	5
Sleeping Capacity - Maximum	5 <sup>1</sup>	6 <sup>1</sup>	6 <sup>1</sup>	6 <sup>1</sup>	6 <sup>1</sup>
Chassis Manufacturer	Chevrolet	Chevrolet	Chevrolet	Chevrolet	Chevrolet
Model	CP31432	CP31832	CP31832	CP31832	CP31832
Wheelbase	158.5"	178"	178"	190"	208"
Axle Ratio	4:10 <sup>4</sup>	4:56	4:56	4:56	4:56
GVWR	12,300 lbs.	14,500 lbs.	14,500 lbs.	14,500 lbs.	14,500 lbs.
GAWR - Front	4,880 lbs.	5,000 lbs.	5,000 lbs.	5,000 lbs.	5,000 lbs.
GAWR - Rear	7,500 lbs.	9,840 lbs.	9,840 lbs.	9,840 lbs.	9,840 lbs.
Engine	454 C.I.D.	454 C.I.D.	454 C.I.D.	454 C.I.D.	454 C.I.D.
Optional Engine	6.2 L Diesel	N/A	N/A	N/A	N/A
Fuel Tank Capacity (Approx.) (Main)	60 gal.	69.7 gal.	69.7 gal.	60 gal.	60 gal.
Hitch Capacity - Ball	200 lbs. <sup>2</sup>	200 lbs.	200 lbs.	200 lbs.	200 lbs.
Hitch Capacity - Towed Vehicle	2,000 lbs. <sup>2</sup>	2,000 lbs.	2,000 lbs.	2,000 lbs.	2,000 lbs.
Roof Load	0	100 lbs.	100 lbs.	100 lbs.	100 lbs.
Total Roof, Hitch and Rear Bumper Weight	200 lbs. <sup>2</sup>	250 lbs.	250 lbs.	250 lbs.	250 lbs.
Fuel Tank Capacity (Auxiliary) (Approx.)	N/A	N/A	N/A	30 gals.	30 gals.

<sup>1</sup>Depends on optional floor plan configuration.

<sup>2</sup>Not available with 6.2 L Diesel option.

<sup>3</sup>Specifications not available at time of publication.

<sup>4</sup>4:56 axle with 6.2 L Diesel option.

<sup>5</sup>Availability subject to change.

# INSTRUMENTS AND CONTROLS

## IGNITION SWITCH - GAS AND DIESEL EQUIPPED VEHICLES

The key operated ignition switch has four positions - Accessory, Off, On and Start. When the key is turned to the "ACC" position, all electrical accessories, such as the radio, will operate without the engine running. The "Off" position is to be used when the vehicle is parked and to shut off the vehicle's engine and accessories. The key must be in the "Off" position to be removed from the column. Turned clockwise to the "On" position, the switch activates the ignition system on the gasoline engine and activates the glow plugs on the diesel engine. To engage the starter, turn the key to the "Start" position. As soon as the engine starts, release pressure on the key and it will return to the "On" position. See "Starting the Engine, in the Chevrolet Owner's and Driver's Manual for additional information on starting the gasoline and diesel engines under various conditions and circumstances.

### ON/GLOW PLUGS ON

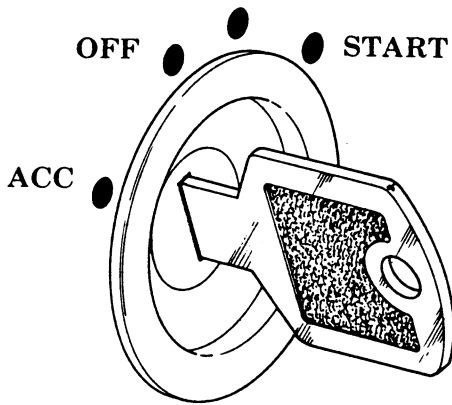

### KEYS

An identification number accompanies every new set of keys. The ignition key may have a small metal tag attached to the set of keys or each key may have a number stamped on a knock out plug in the head. Record the identification number and discard the tag or plug. Keep the identification number in a safe place, never in the vehicle. Should the original key become lost, your dealer or locksmith can provide a duplicate using the identification number.

### POWER STEERING

Power steering is provided as standard equipment on your motor home. By maintaining proper fluid level and ensuring that the drive belt is

always tight, the power steering system should function properly. However, should the system fail due to a malfunction or because the engine has stalled, the vehicle can still be steered, but with a greater amount of effort.

### TILT STEERING WHEEL

Your motor home may be equipped with a tilt steering wheel, which can be raised above the normal position to provide additional room for entrance or exit as well as selected driving positions below normal height. This permits individual selection of the most natural position for driving. On long trips, the steering wheel position can be changed to minimize the tension and fatigue.

The tilt mechanism is operated by lifting up on the small control lever on the left side of the steering column below the turn signal, moving the steering wheel to the desired position and releasing the lever.

### WARNING

Do not adjust steering mechanism while vehicle is in motion.

### TURN SIGNALS

Turn signals should be used whenever a right or left turn is made, when changing lanes or when pulling away from the curb. Always signal your intentions before making a maneuver.

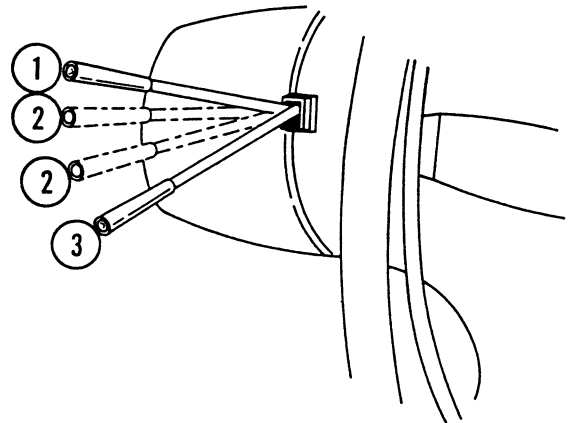

### TURN SIGNAL LEVER

1. Right Turn
2. Lane Change Positions
3. Left Turn



The ignition switch must be in the "On" position for the turn signals to operate. The turn signals can be used in two ways:

**Lane Change** - The first position up or down may be used for changing lanes or when making a gradual turn. The lever must be held in the lane change position; it will return to the neutral position when released.

**Full Turn** - The fully engaged or second position, up or down, is for use when making a normal turn. The turn signal will automatically cancel when the turn is completed.

### IMPORTANT

When the turn indicator lights on the instrument panel do not light, it is an indication that the turn signals are not flashing. The probable cause is a burned out bulb, but until the bulb can be replaced or the system serviced the appropriate hand signals should be used.

## HAZARD WARNING FLASHER

The hazard warning flasher provides additional safety when the vehicle must be stopped on the side of the roadway and presents a possible hazard to other motorists. When the flasher is on, it serves as a warning to other drivers to approach and overtake your vehicle with caution.

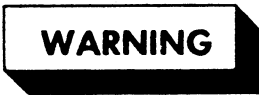

Operating the hazard warning flasher system while moving on the highway is prohibited by law.

**Warning Flasher  
Slider Ring**

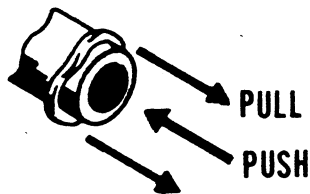

The front directional signals and the taillights will flash intermittently when the flashers are in operation. The hazard warning flashers will not operate when the service brake pedal is depressed. The turn signal will not operate when the flashers

are on. When it is necessary to leave the vehicle, the flasher system will continue to operate with the ignition key removed.

### OPERATION

The hazard warning flasher switch is located on the right side of the steering column. To operate, push the flasher button in to start the flashers and pull the slider ring out to cancel. (See illustration).

## CRUISE CONTROL (Optional on some models)

The cruise control decreases the amount of strain on the driver from constant and steady highway driving. However, the comfort and convenience of the cruise control feature should not substitute for periodic rest stops which allow the driver and passengers to relax.

### IMPORTANT

The cruise control system will not function below 30 miles per hour.



The use of the cruise control is not recommended on icy or wet roads or in congested traffic.

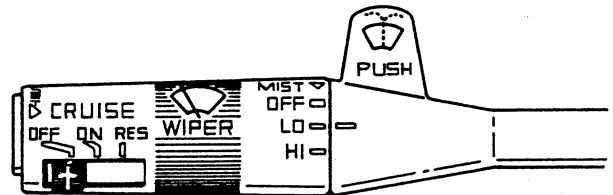

To Activate Cruise Control - Slide switch from "Off" to "On" (located on turn signal lever).

To Engage Cruise Control - Accelerate to desired speed, maintain, depress "Set Speed" button (located in the end of the engagement switch), and slowly release. As soon as the speed has been set, you may remove your foot from the accelerator pedal and the speed will automatically be maintained to within two miles per hour of the set speed.

To Disengage Cruise Control - The cruise control system can be disengaged by stepping on the brake, either when stopping or by lightly depressing the brake pedal while driving, returning the slide switch to the "Off" position, or by turning the ignition switch off.

To Increase Vehicle Speed - Speed can be increased at any time with normal pressure on the accelerator pedal. When the accelerator pedal is released, the vehicle will return to the previously set speed.

To Resume Previously Set Speed - When the system is engaged and brakes have been applied, the previously set speed can be resumed by sliding the switch to "Resume" momentarily and releasing.

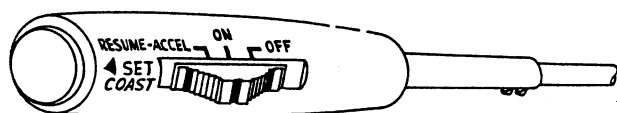

To Activate Cruise Control - Move the slide button of the control switch to the "ON" position.

To Engage Cruise Control - Accelerate to desired speed above 32 miles per hour, press and release "SET/COAST" button, and remove foot from accelerator pedal.

To Coast - Press and hold "SET/COAST" button - speed will decrease (except on steep downgrades). The speed of the vehicle at the moment the button is released will be the new "SET" speed.

To Disengage Cruise Control - Depress the brake pedal slightly or move the slide button to the "OFF" position. Note: When you use the slide button or ignition switch to disengage the system, you erase the "SET" speed from the regulator's memory, therefore the unit can not resume to that speed. Disengaging with the brake does not erase the "SET" speed.

To Resume - After the brake pedal has been depressed to disengage the system, or even to bring the vehicle to a complete stop, you can return to the last "SET" speed by manually driving to a speed above the low speed setting, then moving the slide button to "RESUME/ACCEL" position and releasing it. If the rate of acceleration is too fast or too slow, use the accelerator pedal to bring the vehicle to within 5 miles per hour of the last set speed, then move the slide button to "RESUME/ACCEL" and release it.

To Accelerate - Move the slide button to "RESUME/ACCEL" position and hold it there and the speed will increase. Release the button and the vehicle will return to the previously "SET" speed. To obtain a higher "SET" speed without using the

accelerator pedal, hold the button in "RESUME/ACCEL" position until the desired speed is reached, then release it and quickly press and release the "SET/COAST" button. Note: Speed may be increased any time by normal use of the accelerator pedal. When pressure is released from the pedal, the vehicle will return to the last "SET" speed.

## CRUISE CONTROL

NOTE: The greater the difference between the previously set speed and speed at which you engage "Resume", the faster the vehicle will accelerate. Rapid acceleration can be eliminated by accelerating with the gas pedal to within ten miles per hour of the former set speed and then engaging the resume switch.

## IMPORTANT

The resume feature will not operate if the slide switch has been moved to "Off" to disengage the system or if the ignition switch has been turned off.

## POWER BRAKES

Your motor home is equipped with power brakes to make stopping easier and smoother.

Power Assist (All motor homes) - The braking system on these vehicles is combined with the power steering system which in turn provides power assist to the brakes (hydroboost). However, the fluids in each system are separate. Therefore, DO NOT add hydroboost power steering fluid to the brake master cylinder, or brake fluid to the power steering reservoir. If power assist to the brakes is interrupted due to a stalled engine or a system malfunction, reserve power assist is still available for stopping the vehicle. When reserve power assist is exhausted, the motor home can be stopped manually by applying a greater amount of force to the pedal.

## IMPORTANT

These type of brakes are designed to bring the vehicle to a stop under power assist during a brake failure, when the brake pedal is held down continuously. However, the power assist is partially depleted each time the brake pedal is applied and released. Do not pump the brake when stopping in this manner, except when necessary to maintain steering control on slippery surfaces.

## **WARNING**

Driving through water deep enough to wet the brakes can affect braking performance and cause the vehicle to pull to either side when the brakes are applied. Never operate any vehicle if a difference in braking efficiency is noticeable.

### **AUTOMATIC BRAKE ADJUSTMENT**

All individual wheel brakes, with the exception of the parking brake, are self adjusting. The rear wheel drum brake adjustment is made each time the brakes are applied while the vehicle is moving backwards. Front wheel disc brakes are adjusted automatically each time the brakes are applied.

Should excess brake pedal travel develop, drive alternately in forward and reverse several times and apply the brakes firmly while moving in each direction. See your dealer if this procedure does not restore normal pedal travel.

### **PARKING BRAKE (C-Body Motor Homes)**

The parking brake pedal and release are mounted under the instrument panel to the left of the steering column. To set the parking brake, hold the service brake with your right foot while firmly depressing the parking brake pedal with the left foot. The harder the pedal is pushed, the greater the degree of brake application. To release the parking brake, apply the service brake and pull out on the parking brake release handle, located directly above the parking brake pedal.

### **PARKING BRAKE (A-Body Motor Homes)**

The parking brake control is mounted under the instrument panel to the left of the steering column. The amount of force required to apply the parking brake can be adjusted by turning the adjustment knob on the upper end of the parking brake control lever. This will also adjust the degree of brake application.

Winnebago and Itasca motor homes incorporate two parking brake systems, depending on the motor home model and the chassis on which it was manufactured.

### **ALL A-BODY MOTOR HOMES ( except WCN30RT, ICN30RT, WCN33RU and ICN33RU)**

To set the parking brake, depress the service brake pedal while pulling the parking brake lever back past the over center position

Applying pressure to the service brake pedal will allow the parking brake control lever to exert a greater force on the rear wheel brake drum, thereby rendering the rear wheels immobile.

To release, apply the service brake and push the parking brake lever forward.

### **WCN30RT, ICN30RT, WCN33RU and ICN33RU ONLY**

To set the parking brake, depress the service brake pedal to hold the vehicle in a stationary position only. Pull the parking brake lever back past the over center position to activate the prop shaft brake system. This will prohibit drive shaft movement, there-by rendering the vehicle immobile.

To release, apply the service brake and push the parking brake lever forward.

### **IMPORTANT**

The parking brake should be set before moving the transmission selector lever to the "Park" position whenever leaving the drivers seat. If this procedure is not adhered to, the weight of the vehicle may exert enough force on the parking pawl within the transmission to cause difficulty when attempting to move the selector lever out of the "Park" position.

## **CAUTION**

Never drive the vehicle with the parking brake set. Overheating or damage to the rear brakes could occur.

### **HIGH BEAM INDICATOR LIGHT SWITCH**

The foot operated dimmer switch, located on the floor to the left of the brake pedal, is used to change the headlight beams from high to low, or vice versa. Each time the switch is depressed, the beam changes. The high beam indicator light on the face of the speedometer is illuminated when the headlights are on high beam.

The hand operated dimmer switch, located on the turn signal lever, is also used to change the headlight beams from high to low, or vice versa.

Each time the switch is activated, the beam changes. The high beam indicator light on the face of the speedometer is illuminated when the headlights are on high beam.

The headlight circuit on your motor home is protected by a circuit breaker in the light switch. An overload on the breaker will cause the lights to flicker on and off. If this condition develops, have the headlight wiring checked immediately.

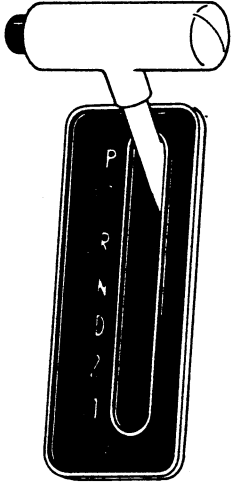

**TRANSMISSION SHIFT LEVER  
WC723RB**

## **AUTOMATIC TRANSMISSION**

An automatic transmission is provided as standard equipment on your motor home. The gear selector lever will be located in one of two positions, depending on your motor home model; on the steering column, or to the right of steering column on the dashboard.

The selector lever should remain in "Park" position when the vehicle is parked. For driving, a choice of Reverse, Drive, Drive 1 and Drive 2 is available. A neutral position can be used when the vehicle is stopped temporarily, such as at a stop light.

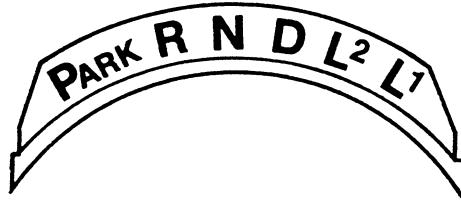

**TRANSMISSION SHIFT LEVER  
A-Body Motor Homes  
(Chevrolet Chassis)  
IC420RG, WC420RG, IC424RC and  
WC424RC C-Bodies**

# INSTRUMENT PANEL

## HEADLIGHT SWITCH

The three position light switch controls the instrument lamps, headlights, marker lights, parking lights, taillights, tag light and interior lights. When the switch is pulled out to the first position, all lights with the exception of the interior lights and the headlights come on. Pulling the switch all the way out to the second position turns on the headlights; however, all lights remain on as well.

### WARNING

Do not use park lights only when vehicle is in motion. Parking lights denote a parked vehicle.

Instrument light intensity can be varied by turning light switch knob clockwise or counterclockwise. Full counterclockwise rotation will turn on an interior light to illuminate the driver's compartment. The back-up lights operate only when the transmission is in reverse.

## WINDSHIELD WASHER AND WIPER (C-Body)

### Dash Mounted Style

The two speed electric wipers are controlled by a switch that is located on the dash to the left of the headlight switch. Moving the switch to the first position operates the wipers at high speed. Pushing the switch to the right at any position, including "O" operates the washer and directs water onto the windshield as long as the switch is held there.

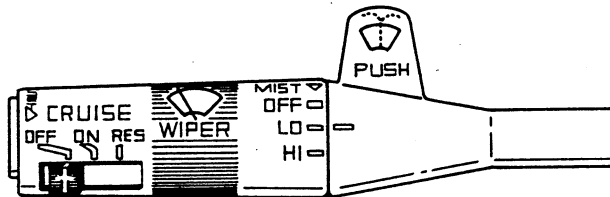

### Lever Mounted Style

The two speed electric wipers are controlled by a switch that is located on the left side of the steering column. To operate the washer, push the chrome washer thumb tab toward the dash. To operate the low or high speed wipers, turn the black portion of the switch toward the indicator mark on the chrome piece to obtain the desired

wiper speed. To manually operate the wipers (mist), turn the black portion of the switch labeled "Mist" until it is aligned with the indicator mark on the chrome piece.

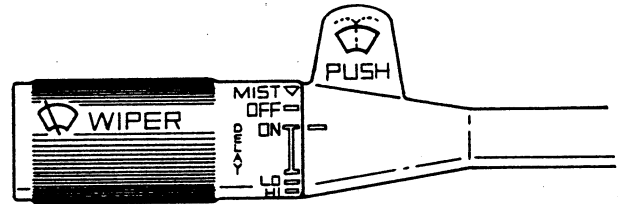

### Lever Mounted Style - Intermittent

The two speed electric wipers with intermittent feature are controlled by a switch that is located on the left side of the steering column. To operate the washer, push the chrome washer thumb tab toward the dash. To operate the low or high speed wipers, turn the black portion of the switch toward the indicator mark on the chrome piece to obtain the desired wiper speed. To manually operate the wipers (mist), turn the black portion of the switch labeled "Mist" until it is aligned with the indicator mark on the chrome piece. To operate the intermittent wipers, turn the black portion of the switch toward the dash until the portion labeled "Delay" aligns with the indicator mark on the chrome portion of the switch.

### Dash Mounted Style - Intermittent

The three position intermittent wiper switch is located on the left side of the dash beneath the air conditioner vent. To operate the washer, push in on the black knob. To operate the intermittent wipers, push the switch toward the right until the first stop, then turn the switch so that the arrow is pointing upward. To operate the wipers at a continuous low speed, push the switch toward the right until the second stop. To operate the wipers at a continuous high speed, push the switch all the way to the right, or the third stop. To shut off the wipers, push the switch all the way to the left.

## WINDSHIELD WASHER AND WIPER (A-Body)

### Two Speed Manual Wipers

The washer and wiper switches are located on the left side of the instrument panel beneath the ventilator. Pressing the left side of the switch activates the wipers at low speed. When the right side is depressed, the wiper will operate at high

speed. A spring loaded rocker switch located to the right of the two wiper switches operates the windshield washer. With the switch held against the spring loaded side, washer solvent/water is directed onto the windshield.

### Intermittent Wipers - A-Body

The intermittent wiper switch is located on the left side of the instrument panel beneath the washer switch. Turning the switch clockwise activates the intermittent wipers. The farther clockwise you turn the switch, the slower the wipers will operate. To turn off the intermittent wipers, turn the switch counterclockwise until it clicks into the off position. The low speed/high speed rocker switch will override this switch at any intermittent setting.

NOTE: During winter months, a windshield washer anti-freeze solution is recommended to avoid damage to the system from freezing.

## HEATER AND AIR CONDITIONER CONTROLS (C-BODY)

### Heater - Defroster

To provide heat to the driver's compartment, slide the selector control to the "Heat" position, adjust temperature control lever as required to give the desired amount of heat and move vertical fan switch up to the desired fan speed. Moving the temperature control all the way to the right provides maximum heat. The fan switch provides three speeds in addition to the "Off" position. Moving the switch to the full upward position provides maximum air flow through the heater.

To operate the defroster, move the selector lever fully to the right (Def.), which will direct the warm air through the defroster vents. You can regulate the distribution of warm air between the defroster and heater by positioning the selector lever between "Heat" and "Def".

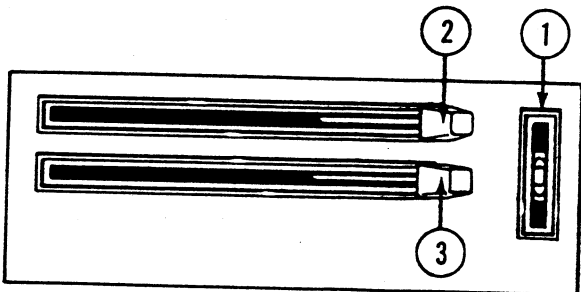

### HEATER CONTROLS

1. Fan Switch
2. Temperature Control Lever
3. Selector Lever

### Automotive Air Conditioner (420RG & 424RB - Gas Engine Only) - Optional

The air conditioner is controlled by two separate knobs located above the heater control panel. The "Air" knob controls the fan speed while the "Temp" knob controls the cooling temperature. The "Air" knob provides three fan speeds which are obtained by rotating the knob clockwise. Rotating the "Temp" knob clockwise produces colder air temperature. For maximum cooling, turn the "Air" knob to the high position and the "Temp" knob to the coldest position.

### IMPORTANT

The automotive air conditioner was not designed to cool the entire interior of the motor home, but is meant to cool only the driver's compartment.

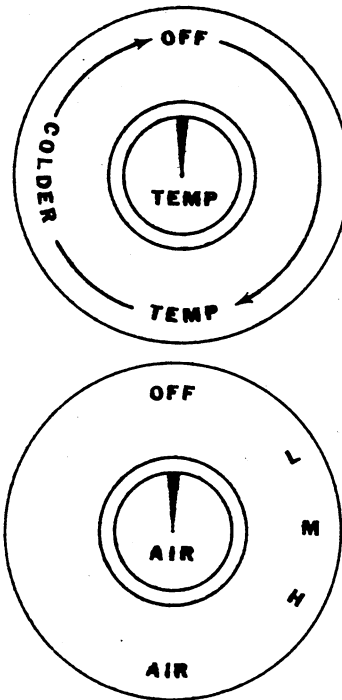

### Combination Auto Air Conditioner/Heater (C-Body) - Optional

The control levers for the air conditioner, heater, defroster and vent are all incorporated into one control panel. Refer to the following instructions for the use of the individual controls.

**Auto Air Conditioner** - To cool the driver's compartment, slide the top function lever to any one of the three positions labeled "Air Cond." Position the bottom temperature lever toward the "Cold" side. The farther the temperature lever is pushed to the left, the colder the air temperature. Turn the "Fan" switch to the desired level of air output. Maximum air conditioning is achieved when the function lever is in the "Max." position,

the temperature lever is pushed all the way to the left ("Cold") and the fan switch is in the "Hi" speed position.

**IMPORTANT**

The automotive air conditioner was not designed to cool the entire interior of the motor home, but is meant to cool only the driver's compartment.

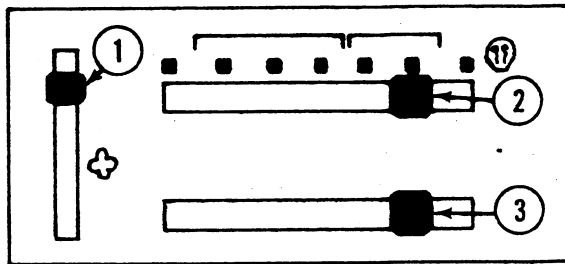

1. Fan Switch
2. Function Lever
3. Temperature Lever

**Heater** - To heat the driver's compartment, slide the top function lever toward the right to the "Heat" position. Turn the fan switch to the desired level of air output and slide the temperature lever toward the right (Hot) to obtain the desired temperature.

**Defroster** - To defrost or defog the windshield, slide the top function lever toward the right to the "Def." position. Turn the fan switch to the desired level of air output and slide the temperature lever to the desired temperature.

**Vent** - To provide outside air to the interior of the motor home, slide the top function lever to the "Vent" position. Turn the fan switch to the desired level of air output and slide the temperature lever to the desired temperature blend.

**Combination Auto Air Conditioner Heater (All A-Body) - Optional**

The controls for the air conditioner, heater, defroster and vent are all incorporated into one control panel. Refer to the following instructions for the use of the individual controls.

**Auto Air Conditioner** - To cool the driver's compartment, push the button labeled "A/C" or "MAX A/C". The "A/C" function blends fresh air with the cooled air; the "MAX A/C" continually recirculates the inside air. Slide the top temperature

lever to the left to obtain the desired temperature. Turn the "Fan" selector switch to the desired level of air output. Maximum cooling is achieved by pushing the "MAX A/C" button, sliding the temperature lever totally to the left (cool) and turning the fan switch to the "Hi" position.

**IMPORTANT**

The automotive air conditioner was not designed to cool the entire interior of the motor home, but is meant to cool only the driver's compartment.

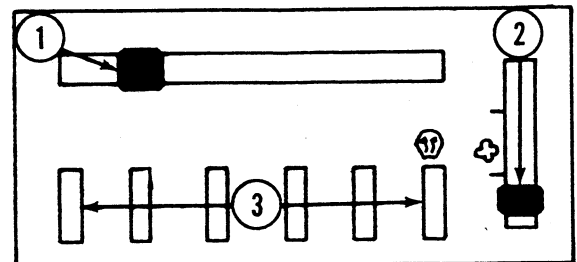

1. Temperature Lever
2. Fan Switch
3. Function Switches

**Heater** - To heat the driver's compartment, push in the "HEAT" switch. Turn the fan switch to the desired level of air output and slide the temperature lever toward the right ("WARM") to obtain the desired temperature.

**Defroster** - To defrost or defog the windshield, push in the "Defrost" switch. Turn the fan switch to the desired level of air output and slide the temperature lever to the desired temperature. The direction of the defroster air flow can be regulated by turning the vents on top of the dash to the desired area.

**Vent** - To provide outside air to the interior of the motor home, push in the "Vent" switch. Turn the fan switch to the desired level of air output and slide the temperature lever to the desired temperature blend.

**BATTERY CONDITION METER AND SWITCH (Optional on Some Models)**

This gauge is a voltmeter which allows the driver to monitor the state of charge of all batteries in the motor home. The gauge will indicate the state of charge of the automotive

battery when the left side of the switch is depressed or the charge in the auxiliary battery when the right side of the switch is depressed. To obtain an accurate reading, the dual battery switch must be in the neutral position and the automotive engine and optional 110-volt generator must not be running. This meter and switch are located on an overhead console on all C-body motor homes and above the heater controls on all A-body motor homes.

### **AUXILIARY GENERATOR SWITCH (Motor Homes Equipped with 110V Generator Option)**

This start/stop switch controls the 110-volt auxiliary generator. It allows the generator set to be started or stopped without leaving the motor home.

### **AUXILIARY GENERATOR HOURMETER (Motor Homes Equipped with 110V Generator Option)**

This meter registers the number of hours the auxiliary generator has operated. Use it as a reminder of when the generator unit is due for periodic lubrication and routine maintenance. This meter as well as the generator on/off switch is located above the radio on all A-body motor homes and on an overhead console on all C-body motor homes.

### **BRAKE WARNING LIGHT**

The service brake system in your motor home is a dual system which provides a reserve braking capability if either part of the system fails. Failure of either half of the dual system is indicated by the brake system warning light, which will glow and remain lit until the brake system failure is corrected. The light is connected to the ignition switch and should glow during engine starting to verify that the bulb is operating properly. The light will then go off when the engine starts unless a brake failure is evident.

#### **IMPORTANT**

This warning light is not to be used as a substitute for a visual check of the brake fluid level, required as part of normal maintenance.

#### **WARNING**

If brake failure is indicated, immediate repair service is necessary. Continued operation of the vehicle in

this condition is dangerous. Never operate any vehicle if a difference in braking efficiency is noticeable.

### **SPEEDOMETER**

The speedometer needle indicates the vehicle's forward speed in miles per hour and kilometers per hour. The six-figure odometer located in the lower center section of the speedometer indicates the accumulated mileage, or on Canadian units, the accumulated kilometers figure. The odometer should be used as a reminder of when the vehicle is due for periodic lubrication and routine maintenance.

### **CIGARETTE LIGHTER**

To use the cigarette lighter, simply push and release the knob. As soon as the element is hot, the knob will "POP" out part way.

### **CLOCK (Optional)**

The optional electric clock operates from the automotive battery. Adjust the clock for proper time by pulling out and turning the reset knob.

### **OIL PRESSURE GAUGE**

The oil pressure gauge indicates the pressure at which oil is being delivered to the various parts of the engine. Upon starting the engine, the pointer should move to the normal range of the gauge. However, higher or lower readings may be indicated because of variable operating conditions such as outside air temperature and weight of oil being used. If the pointer drops below the normal range while the engine is running, it is an indication of a loss of pressure and the motor home should be stopped as soon as possible and the engine shut off.

Check the oil level in the engine and add oil when necessary. The oil pressure gauge should not be used as an indicator of the engine oil level. Several factors could cause loss of oil pressure even though the oil level is normal. Do not operate the engine when the gauge pointer is below the normal operating band. Operating without oil pressure can quickly destroy the engine bearings and other engine parts.

### **TEMPERATURE GAUGE**

This gauge indicates the engine coolant temperature. As the engine becomes warm, the pointer will move to the normal range of the gauge. Coolant temperature and, therefore, gauge readings, may vary depending on weather and traffic conditions. There is no danger to the engine unless the gauge pointer moves all the



way right to the "H" (hot) position. If it does, stop the vehicle or reduce speed to permit the engine to cool.

## WARNING

Never add coolant to the radiator when the engine is overheated. Do not loosen or remove the cap to cool an overheated engine. Refer to "Engine Cooling System", pages 106 and 107 for further cautions and instructions on adding coolant to the radiator.

## FUEL GAUGE

With the ignition switch in the "On" or "Accessory" position, the fuel gauge registers the approximate fuel level in the tank. Due to the design of the fuel system, some fuel will remain in the tank when the engine runs out of fuel. To avoid fuel run-out problems and to eliminate condensation in the fuel, it is a good practice to keep the fuel tank at least half full.

## IMPORTANT

Avoid running out of fuel in diesel powered units as special assistance may be required to restart the engine.

## FUEL SELECTOR SWITCH (A-Body Motor Homes with Optional Auxiliary Fuel Tank Only)

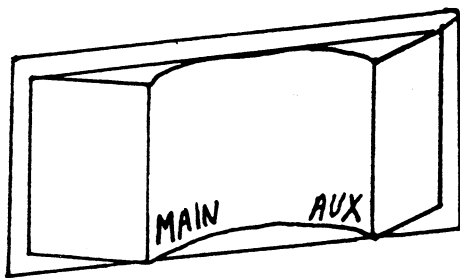

The fuel tank selector switch is incorporated into the dashboard of the motor home. It is connected to an electronically controlled three-way solenoid valve mounted on the chassis near one of the fuel tanks. Switching the fuel tank selector switch to the "Aux" position energizes the valve solenoid causing the valve to open allowing fuel to flow from the auxiliary fuel tank. When the fuel tank selector switch is pushed to the "Main" position, the solenoid is de-energized, closing the auxiliary fuel tank valve. This allows fuel to flow from the main tank only.

To obtain fuel from the auxiliary tank, push the side of the fuel selector switch labeled "Aux". To obtain fuel from the main tank, push the side of the switch labeled "Main".

## IMPORTANT

It is necessary to switch to auxiliary fuel supply before the main fuel tank is empty. There must be enough fuel in the main tank or the carburetor to start the engine. Do not allow the main tank to run dry and the engine to stop. It will not be possible to start the engine again. Even though the fuel selector switch is in the "Aux" position, turning the ignition switch to "Start" position cuts power to all accessories including the fuel selector valve. As long as the ignition key is held in the "Start" position, the fuel selector is switched to the main tank, which in this case is empty. To start the engine under these conditions, follow the steps below.

1. Supply main tank with enough fuel to start the engine.
2. Prime carburetor with fuel.
3. Supply 12-volt current to solenoid valve to keep it locked into the "Aux" position until the engine is started.

## IMPORTANT

Keep in mind that the optional 110-volt generator draws fuel from the main tank on all gasoline equipped vehicles. Therefore emptying the auxiliary fuel tank first will assure an adequate supply of fuel to operate the generator when desired.

## ALTERNATOR INDICATOR

### Ammeter Gauge

This "0" (zero) center meter indicates whether the battery is being charged or discharged. When the battery is being charged properly, the pointer should stay near the center or slightly to the right of the center mark. Should the indicator move to the extreme left, it indicates a malfunction in the electrical system. Have the motor home electrical system checked as soon as possible.

## VACUUM — FUEL ECONOMY GAUGE (GAS ENGINE ONLY) (A- BODY ONLY) — OPTIONAL

This gauge provides a value guide to efficient engine operation. It is impossible to specify an ideal gauge reading, as this will vary a great deal under various operating conditions. However, as a general rule, a high reading usually indicates the most efficient engine operation and the best fuel economy. The vacuum level will be high at

idle speed, and as speed and load increase, the vacuum level will drop. To obtain maximum fuel economy, operate the motor home in such a way as to maintain vacuum level as high as possible.

### **DUAL BATTERY SWITCH (GAS ENGINE ONLY)**

The dual battery switch permits connecting the auxiliary battery to the automotive electrical system, permitting it to be charged by the engine alternator while driving. In the event of automotive battery failure, the vehicle engine can be started by holding the switch in the momentary position to obtain additional starting power from the auxiliary battery.

The dual battery switch is located either on the dashboard, overhead console or on the left wall panel behind the driver's seat.

#### **CAUTION**

Do not turn on the optional 110V generator with both batteries connected while driving. This can cause damage to the automotive alternator. Never leave the dual battery switch in the dual position when parked as it could cause both batteries to discharge.

### **"GLOW PLUGS ON" INDICATOR LIGHT — DIESEL EQUIPPED VEHICLES**

This light is included on all vehicles equipped with a diesel engine, and indicates when the glow plugs are operating. See "Starting the Diesel Engine" in the Chassis Manufacturers Owner's and Driver's Manual.

### **"WATER IN FUEL" INDICATOR LIGHT — DIESEL EQUIPPED VEHICLES**

This light is included on all vehicles equipped with a diesel engine. When illuminated, this light is indicating that the fuel system contains a quantity of water that must be removed as soon as possible. See "Water in the Fuel - Diesel Engine", page 42.

### **"LOW COOLANT" WARNING LIGHT DIESEL EQUIPPED VEHICLES**

This light is included on all vehicles equipped with a diesel engine. The light is designed to illuminate during engine starting to serve as a bulb check. Once the engine starts, however, the light should go out. If the light continues to

illuminate, or comes on when driving, have the radiator coolant level checked immediately.

#### **WARNING**

Be careful when removing the overflow bottle cap when the engine is hot; allow the pressure to release gradually. **Take care not to burn your hands.**

#### **CAUTION**

Never fill a hot engine with cold coolant if a considerable quantity of fluid has been lost as this may lead to permanent damage to your engine block.

#### **CAUTION**

Use only the proper mixture of ethylene-glycol antifreeze coolant in your cooling system. It has a definite pink or blue tint and is not clear. In addition to being a rust preventative and to aid in lubricating the water pump, this coolant will prevent freezing and subsequent damage to the engine block. See your authorized dealer to obtain the recommended mixtures for your climate. The use of any borax based anti-freeze is not recommended.

## INSTRUMENT PANEL - C-Body (Chevrolet Chassis - 6.2 L Diesel Equipped)

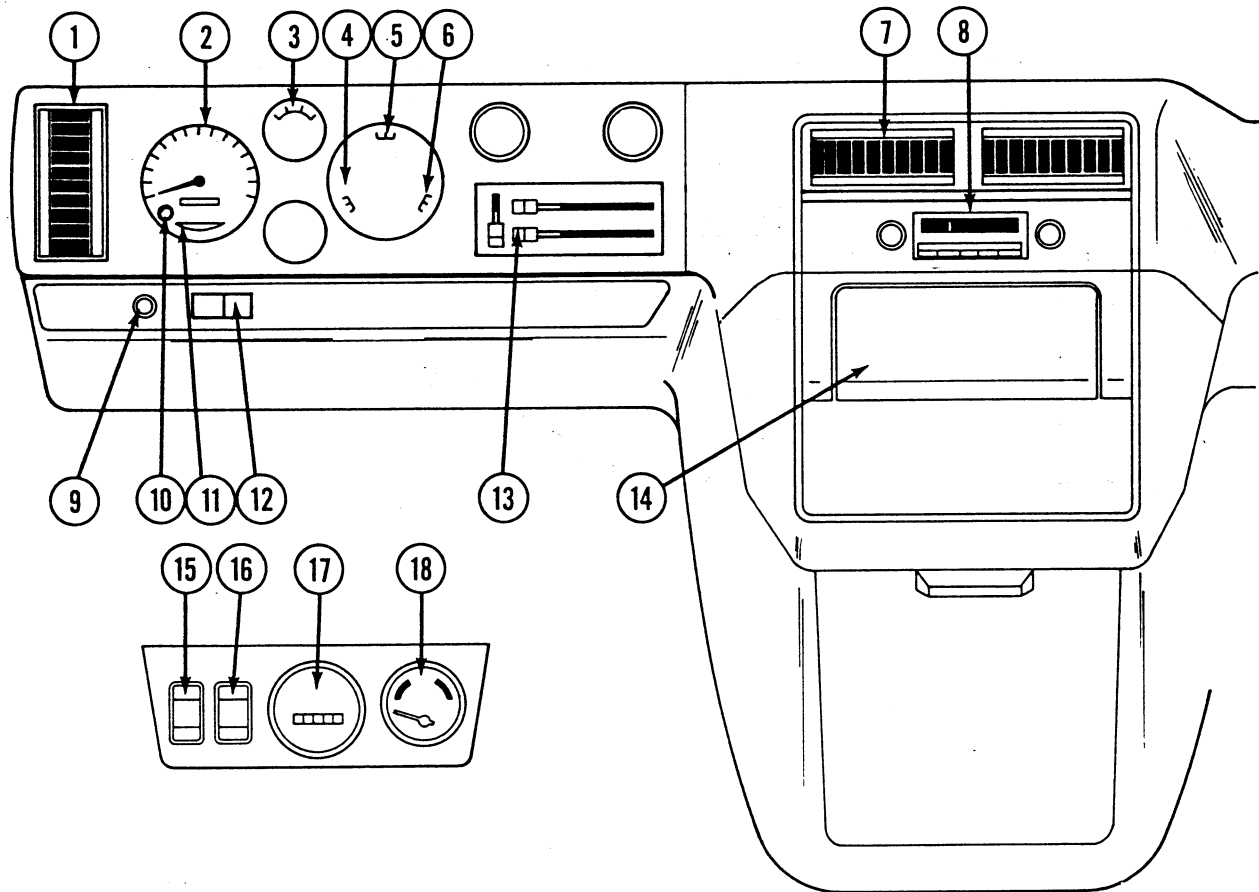

1. Air Conditioner Vents (if equipped)
2. Speedometer
3. Fuel Gauge
4. Oil Pressure Gauge
5. Temperature Gauge
6. Voltmeter
7. Air Conditioner Vents (if equipped)
8. Radio
9. Headlight Switch
10. Low Coolant Light
11. Brake Warning Light
12. Combination Glow Plug/Water in Fuel Indicator Light
13. Air Conditioner/Heater (Air Conditioner Optional)
14. Ashtray/Cigarette Lighter
15. Battery Condition Switch (Optional)
16. 110 Volt Generator Start/Stop Switch (Optional)
17. Generator Hourmeter (Optional)
18. Battery Condition Meter (Optional)

## INSTRUMENT PANEL - C-Body (Chevrolet Chassis - Gas Equipped)

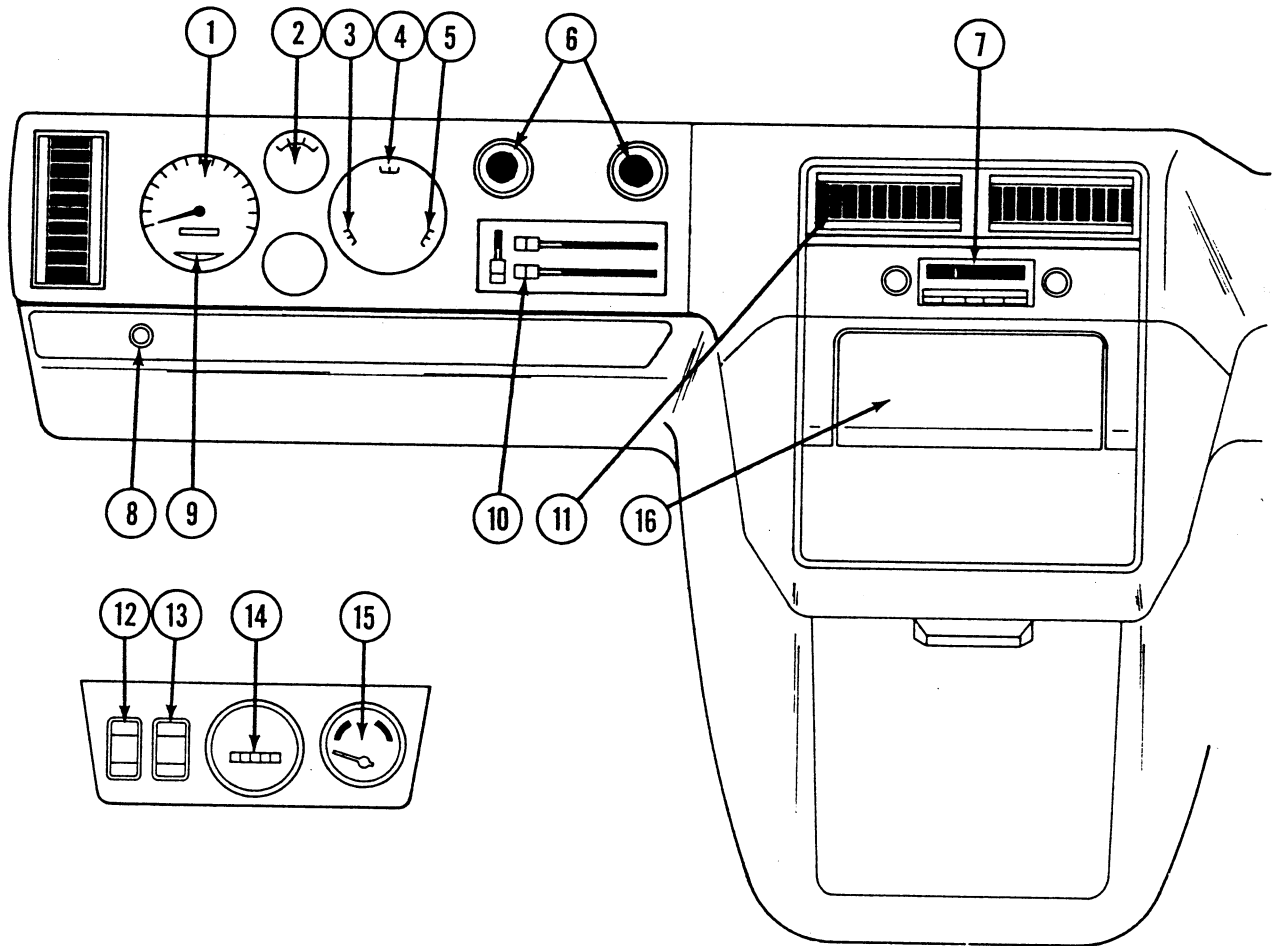

1. Speedometer
2. Fuel Gauge
3. Oil Pressure Gauge
4. Temperature Gauge
5. Voltmeter (Alternator Indicator)
6. Air Conditioner Controls (Optional)
7. Radio
8. Headlight Switch
9. Brake Warning Light
10. Heater Controls
11. Air Conditioner Vents (if equipped)
12. Battery Condition Switch (Optional)
13. 110 Volt Generator Start/Stop Switch (if equipped)
14. 110 Volt Hourmeter (if equipped)
15. Battery Condition Meter (Optional)
16. Cigarette Lighter

# INSTRUMENT PANEL - C-Body (Winnebago Built Cabs) - Gas Equipped Vehicles

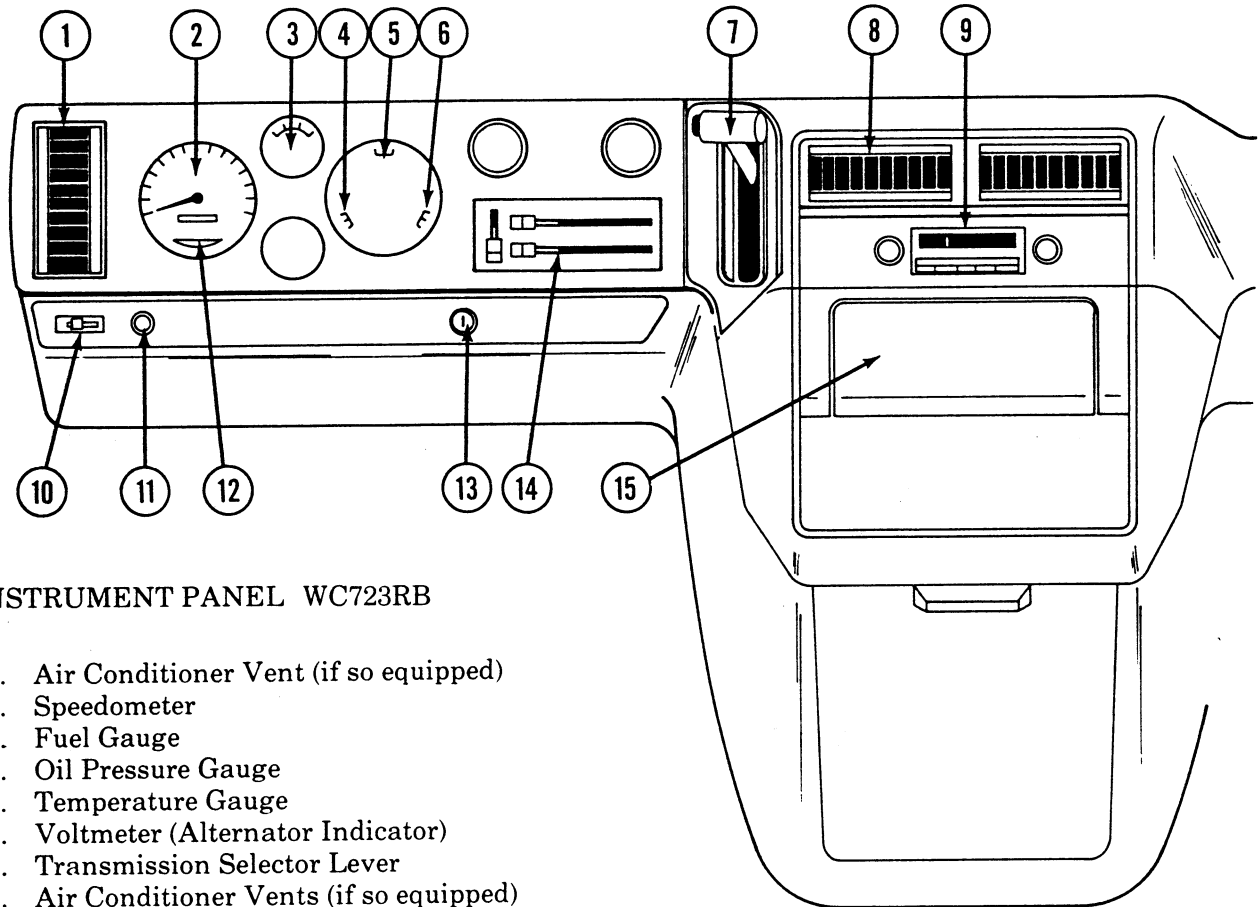

## INSTRUMENT PANEL WC723RB

1. Air Conditioner Vent (if so equipped)
2. Speedometer
3. Fuel Gauge
4. Oil Pressure Gauge
5. Temperature Gauge
6. Voltmeter (Alternator Indicator)
7. Transmission Selector Lever
8. Air Conditioner Vents (if so equipped)
9. Radio
10. Windshield Washer/Wiper Switch
11. Headlight Switch
12. Brake Warning Light
13. Ignition Switch
14. Heater/Air Conditioner Controls (A.C. Optional)
15. Cigarette Lighter

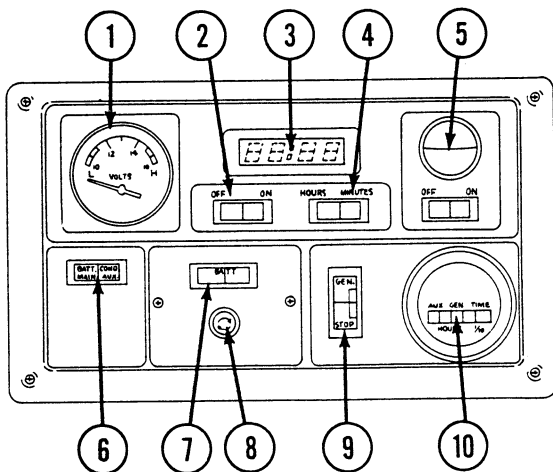

## TRAVEL CENTER

1. Voltage Gauge
2. Digital Clock Switch
3. Digital Clock
4. Digital Clock Set Switch
5. Map Light
6. Battery Condition Switch (Optional)
7. Dual Battery Switch
8. Dual Battery Circuit Fuse
9. 110-Volt Generator Start/Stop Switch (Optional)
10. 110-Volt Generator Hourmeter (Optional)

# INSTRUMENT PANEL - A-Body (Chevrolet Chassis - 6.2 L Diesel Equipped)

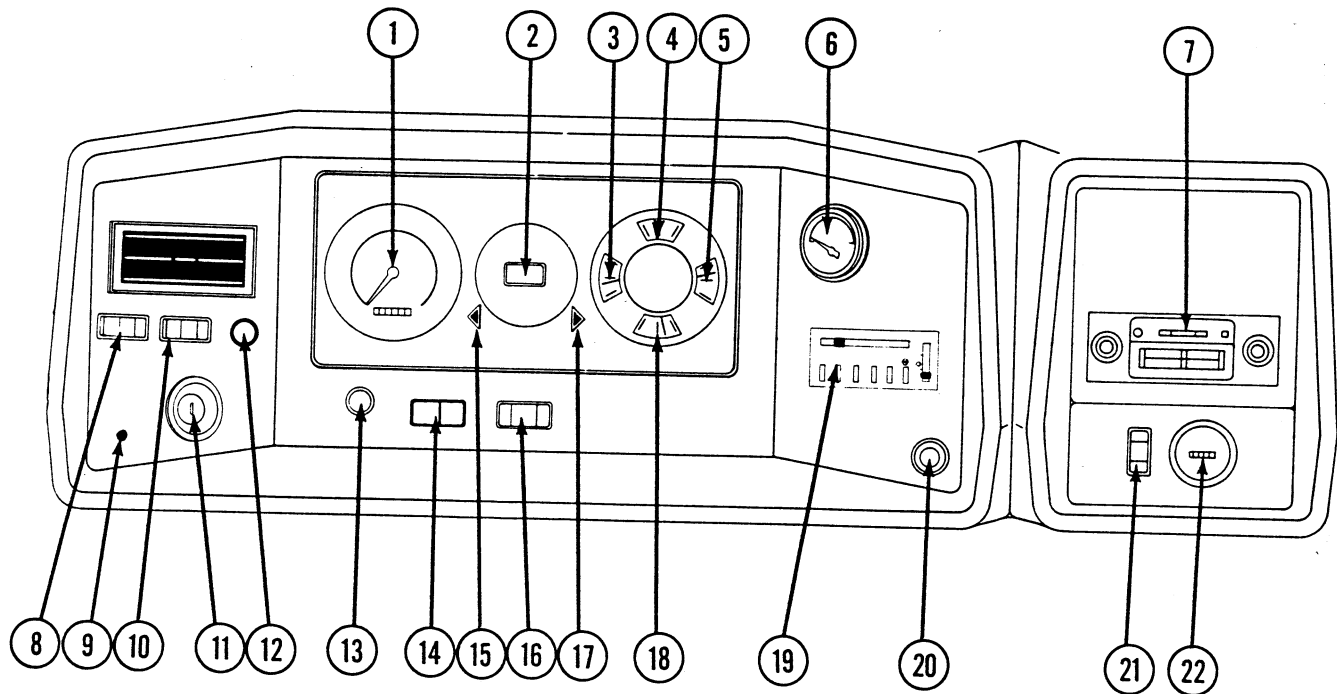

1. Speedometer
2. Brake Warning Light
3. Voltmeter
4. Fuel Gauge
5. Oil Pressure Gauge
6. Battery Condition Meter
7. Radio
8. Windshield Wiper Switch
9. Intermittent Wiper Control
10. Windshield Washer Switch
11. Ignition Switch
12. Low Coolant Light
13. Headlight Switch
14. Combination Glow Plugs/Water in Fuel Indicator Light
15. Left Turn Indicator Light
16. Battery Condition Switch
17. Right Turn Indicator Light
18. Temperature Gauge
19. Heater/Air Conditioner Controls (A.C. is Optional)
20. Cigarette Lighter
21. 110-Volt Generator Start/Stop Switch (Optional)
22. 110-Volt Generator Hourmeter (Optional)

## INSTRUMENT PANEL - A-Body (Chevrolet Chassis - Gas Equipped)

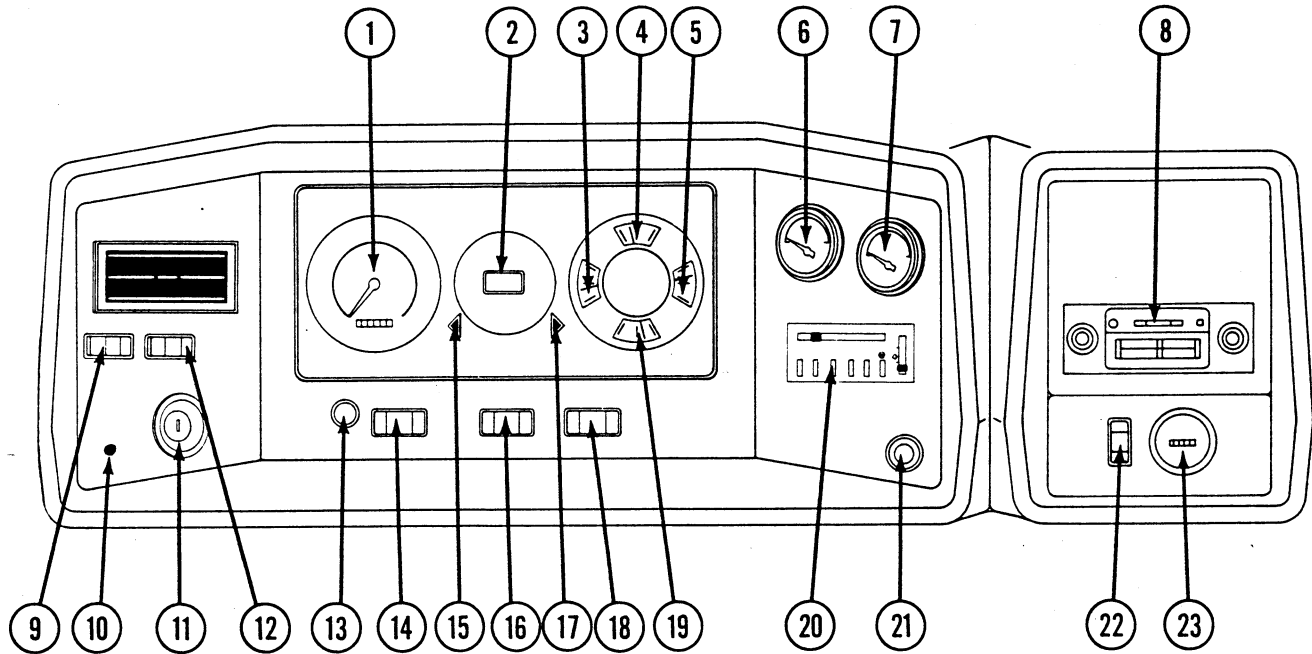

1. Speedometer
2. Brake Warning Light
3. Voltmeter
4. Fuel Gauge
5. Oil Pressure Gauge
6. Battery Condition Meter
7. Vacuum (Fuel Economy) Gauge
8. Radio
9. Windshield Wiper Switch
10. Intermittent Wiper Control
11. Ignition Switch
12. Windshield Washer Switch
13. Headlight Switch
14. Auxiliary Fuel Tank Changeover Switch
15. Left Turn Indicator
16. Battery Condition Switch
17. Right Turn Indicator
18. Dual Battery Switch
19. Temperature Gauge
20. Heater/Air Conditioner Controls (A.C. is Optional)
21. Cigarette Lighter
22. 110-Volt Generator Start/Stop Switch (Optional)
23. 110-Volt Generator Hourmeter (Optional)

# RADIOS

Basically, all radios are tuned and operated in a similar manner. Refer to the directions below and to the specific illustration of the radio in your vehicle.

## IMPORTANT

All radios have an in-line fuse between the radio and the fuse block to protect the radio wiring. A second protection fuse is located in the fuse block itself. If the radio fails to operate, check both fuses and replace with a new fuse of the same value if found to be defective.

## AUDIOVOX HI-COMP AM/FM CASSETTE STEREO (ELECTRONIC TUNE)

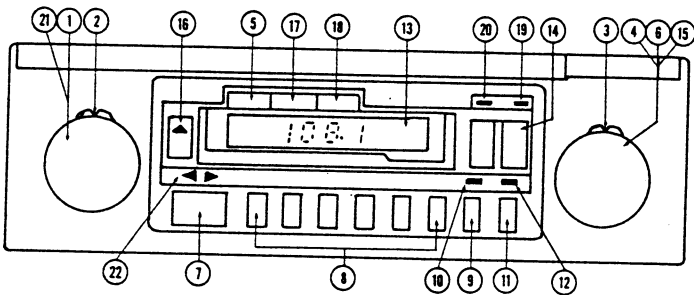

### 1. ON-OFF/VOLUME

Turn the knob until a click is heard, and rotate until the desired volume is attained.

#### TREBLE CONTROL (Pull)

Adjust the control for the desired treble reproduction.

### 2. BASS CONTROL

Adjust the control to obtain the desired bass reproduction.

### 3. FADER CONTROL

To balance the front and rear speakers, rotate it in the desired direction. The FADER control will only function if the system uses four speakers.

NOTE: If an external equalizer or power amplifier is used with pre-amp output jack, the fader will be inoperative and an external fader control and/or a fader control on equalizer must be used.

### 4. LEFT-RIGHT BALANCE (Pull)

To balance the left and right speakers, pull the knob and rotate to left or right. (Also see FADER control)

### 5. LOUDNESS CONTOUR SWITCH

When listening to music at low volume levels, this switch should be depressed so as to boost the bass and treble tones slightly and compensate for the characteristics of human hearing.

### 6. MANUAL TUNING

To manually select a radio station, rotate knob to right. The radio will advance one digit higher. If you hold the knob in, it will rapidly advance digits until released. To tune downward, rotate knob to left.

#### AUTO SEARCH TUNING

Depress button again and repeat until desired station is reached. If search is progressing up (to higher frequency) and you want to lower station, rotate manual tuning knob to left. To scan up, rotate knob to right then depress search button.

NOTE: Local-distant switch effects the sensitivity of this function (in local mode only strong signals will be identified, in Distant mode all signals will be identified).

### 7. AM-FM BAND SELECTOR

To select the AM radio band, lightly depress this button. For the FM band depress the button further in. The letters AM or FM will appear on Display Panel (13) according to your selection.

### 8.&9. DUAL AM-FM MEMORY BUTTONS

To pre-set any of these six memory buttons, perform the following:

- Turn unit on and select AM band.
- Select first station to be pre-set using manual tuning or Auto search.
- Depress memory enable button. Memory light (10) will illuminate.
- Depress the first button to be pre-set within 8 seconds. The memory light will go out indicating the first station is pre-set.
- Repeat for remaining five buttons. Now switch to FM band and reset all six buttons for FM stations. The circuitry in the memory systems allows you to pre-set up to 12 stations (6 AM, 6 FM) using only six buttons. NOTE: The memory system will be erased should the automotive battery be disconnected for any reason.



**10. MEMORY INDICATOR**

**11. LOCAL/DISTANT**

This control is used for selecting "stop sensitivity" in AUTO SEARCH mode.

**DX MODE**

When you wish to select the weak signal station using Search button, please push "AUTOSEARCH" button after you depress the "LOCAL" switch, (as in LOCAL mode).

**LOCAL MODE (Local Ind. (12) On)**

In case there are so many stations or you wish to select only local stations with SEARCH button, please push "AUTO SEARCH" button after you select the "LOCAL" mode. While it is in searching mode, weak signal station is automatically cut off.

**12. LOCAL INDICATOR**

**13. LED DISPLAY PANEL**

This special panel will display radio frequency, time, AM, PM, AM-FM band indications.

**STEREO LIGHT**

This will illuminate whenever you receive a stereo station. If the light flickers or goes on and off as you drive, it is an indication that the stereo signal is too weak to reproduce and you should select another station.

**14. FF, REW**

In order to advance the tape rapidly during playback, simply depress the Fast-Forward Button. When you want to resume normal play, lightly press the Rewind Button until the F.F. Button disengages. To rapidly rewind the tape, depress the Rewind button fully and lightly press the F.F. Button to resume normal play. During these operations the Program Indicator Lights will indicate the direction of tape movement.

**15. PROGRAM SELECT**

While playing a cassette you may desire to change sides manually before the completion of one side of play. To do this simply depress and release the program knob. You will find that one program indicator light (22) will go out and the other will illuminate.

**16. EJECT**

When this button is pressed, playback is stopped and the cassette ejected. It also has the effect of switching over to radio operation.

**17. METAL TAPE SELECTOR**

During tape operation this switch functions as a Metal Equalization Switch. The unit incorporates a special hard permalloy tape head designed for excellent fidelity from all cassette tapes and this special selector allows the use of hi-fidelity metal cassette tapes. When using normal cassettes (Fe, FeCr types), place the switch in the "out" position. Always position the switch to the proper setting before inserting a cassette.

**18. DOLBY®**

For the discerning listener this feature provides the best in tape reproduction, eliminating the hiss and high level distortion normally associated with standard cassette players. For best results, use cassettes recorded with Dolby noise reduction.

**19. DOLBY INDICATOR**

Illuminates when the unit's Dolby noise reduction feature is switched on.

**20. METAL INDICATOR**

Illuminates when the cassette unit is set for metal cassettes.

**21. DISPLAY PRIORITY SWITCH**

If you wish to display clock normally, push this switch. On the other hand, if you wish to display radio frequency normally, push the switch once again.

**TO SET TIME:**

- A. Turn unit on and select time display.
- B. Depress and hold memory button (9) in.
- C. Turn manual tuning knob to left to change hours or to right to change minutes.
- D. Rotate manual tuning knob once for each hour or minute to be advanced. If knob is held in, hours or minutes will rapidly advance.

NOTE: The LED display panel will either illuminate "AM" or "PM". Make certain it corresponds to appro-

- ropriate time. If not, advance clock by 12 hours to change indicator.
- E. Once correct hour is obtained repeat for correct minute then release memory button.

## 22. PROGRAM INDICATOR

### AUDIOVOX HI-COMP AM/FM CASSETTE STEREO (MANUAL TUNE)

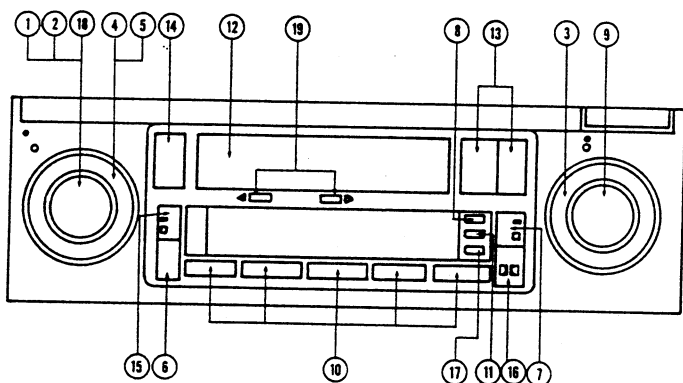

#### 1. ON-OFF/VOLUME

Turn the knob until click is heard, and rotate until the desired volume is attained.

#### 2. LEFT-RIGHT BALANCE (Pull)

To balance the left and right speakers, pull the knob and rotate to left or right. (Also see FADER control)

#### 3. FADER CONTROL

To balance the front and rear speakers, rotate it in the desired direction.

NOTE: If an external equalizer or power amplifier is used with pre-amp output jacks, the fader will be inoperative and an external fader control and/or a fader control on equalizer must be used.

#### 4. BASS CONTROL

Adjust the control to obtain the desired bass reproduction.

#### 5. TREBLE CONTROL (Push)

Adjust the control for the desired treble reproduction

#### 6. LOUDNESS CONTOUR SWITCH

When listening to music at low volume levels, this switch should be pressed to boost

the bass and treble tones slightly and compensate for the characteristics of human hearing.

#### 7. AM-FM BAND SELECTOR

To select AM radio band depress and release this button (button must be in "out" position for AM).

For FM band depress button (button must be in "in" position for FM).

The BAND indicator is illuminated red for AM and green for FM.

#### 8. BAND INDICATOR

#### 9. MANUAL TUNING

Having selected either AM or FM band with band selector, use this control to manually select broadcast station. When using manual tuning it is important to carefully fine-tune for optimum reception. The dial pointer will move along the dial as you tune, to indicate the frequency you are selecting.

#### 10. PRECISION PUSHBUTTON TUNING

Five pushbutton stations selectors are incorporated into this radio. You may pre-set them to any band you desire (AM or FM) or any combination you want. To set pushbuttons follow this procedure:

- A. Select AM or FM band.
- B. Use manual tuning control to select the desired station (tune carefully).
- C. Pull the first pushbutton fully out.
- D. Re-check that station is exactly tuned in.
- E. Press button fully in until it stops then release.

You have now set the first pushbutton. Repeat these steps for the remaining four pushbuttons.

#### 11. STEREO INDICATOR

This will illuminate whenever you receive a stereo station. If the light flickers or goes on and off as you drive, it is an indication that the stereo signal is too weak to reproduce and you should select another station.

#### 12. CASSETTE DOOR

The cassette should be checked to assure that the tape is tightly wound on the spools before inserting. To properly insert the cassette, hold it so the narrow side faces the door with the exposed tape edge to the right. Insert tape into opening. Depress fully until

cassette is engaged and mechanism starts playing.

**13. FF, REW**

In order to advance the tape rapidly during playback, simply depress the Fast-Forward Button. When you want to resume normal play, lightly press the Rewind Button until the FF Button disengages. To rapidly rewind the tape, depress the Rewind Button fully and lightly press the FF Button to resume normal play. During these operations the Program Indicator Lights will indicate the direction of tape movement.

**14. EJECT**

When this button is pressed, playback is stopped and the cassette is ejected. It also has the effect of switching over to radio operation.

**15. TAPE EQUALIZATION SELECTOR**

During tape operation this switch functions as a Tape Equalization Switch. The unit incorporates a special hard permalloy tape head designed for excellent fidelity from all cassette tapes and this special selector allows the use of hi-fidelity metal cassette tapes. For CrO<sub>2</sub>/METAL tapes select 70 which is the "IN" position, and for normal tape (Fe/or FeCr) Select 120 which is the "OUT" position.

**16. DOLBY NR SWITCH**

For the discerning listener this feature provides the best in tape reproduction, eliminating the hiss and high level distortion normally associated with standard cassette players. For best results use cassettes recorded with Dolby noise reduction.

**17. DOLBY NR INDICATOR**

Illuminated when the unit's Dolby noise reduction feature is switched on.

**18. PROGRAM SELECTOR**

Push this knob to change the program (the direction of tape running).  
(Note: Program is automatically reversed at the end of tape.)

**19. PROGRAM INDICATOR**

TAPE DIRECTION

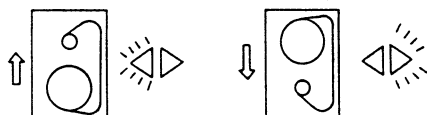

**AUDIOVOX AM/FM/STEREO CASSETTE PLAYER (MANUAL TUNE)**

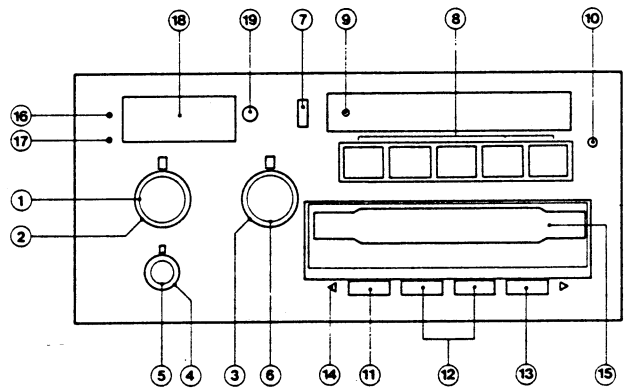

**1. ON-OFF SWITCH/VOLUME CONTROL**

To provide power to the unit, it is necessary to turn this control knob clockwise until a slight "click" is heard. To increase volume, continue rotating the knob to desired level.

**2. FRONT/REAR BALANCE CONTROL**

This control allows you to balance the output between the front and rear speakers. When used in conjunction with the LEFT/RIGHT STEREO BALANCE CONTROL you have full 4-way stereo balance capability.

**3. LEFT-RIGHT BALANCE**

To balance sound from left to right rotate rear knob as desired.

**4. BASS CONTROL**

Rotate this knob clockwise for increasing bass tone, counterclockwise for decreasing it.

**5. TREBLE CONTROL**

Rotate this knob clockwise for increasing treble tone, counterclockwise for decreasing it.

**6. MANUAL TUNING**

This allows manual selection of all broadcast stations. Simply turn knob to left or right for station selection. Always adjust this control carefully for optimum station reception.

**7. BAND SELECTOR**

Slide knob to upper position for reception of FM signals and to lower position for reception of AM signals.

**8. PUSHBUTTON TUNING**

The five pushbuttons located below the

radio dial may be set to any combination of 5 AM or FM stations (3 AM, 2 FM or 1 AM, 4 FM, etc.) or to only AM or only FM stations. Any button may be changed without disturbing the other pre-set buttons (see **SETTING PUSHBUTTONS**).

#### **SETTING PUSHBUTTONS**

1. Turn the radio on.
2. Pull out the first button to be set (grasp button and pull toward you until it stops).
3. Manually tune in the desired station. Make certain you are exactly tuned in (see manual tuning).
4. Lock-in the station by pushing the button fully in.
5. Repeat steps 2, 3 and 4 for the remaining buttons.

**NOTE:** To assist you in remembering which button is set to which station, we recommend you use buttons on the left side for stations near the low end of the dial; center buttons for mid-frequency stations, etc.

#### **9. STEREO LIGHT**

While the FM stereo broadcast is being received, this indicator is automatically turned on.

#### **10. ANTENNA TRIMMER**

It is very important to adjust the **ANTENNA TRIMMER** for optimum AM reception. Tune in a weak station around 1400 KHz and adjust the trimmer with a small screw driver for maximum output. The antenna trimmer is adjusted during installation for proper reception and not be re-adjusted unless the antenna or cable is replaced.

#### **11.-14. AUTO REVERSE CASSETTE MECHANISM**

To operate cassette player, turn unit on. Radio will start to play. (Insert cassette so the open edge of the cartridge faces the cartridge opening in the player). Gently slide cassette in until mechanism actuates and draws cassette into unit. Play will start automatically. Once one side of play is completed, the unit will automatically reverse and play the other side. Program lights will illuminate to show direction of tape travel (program side 1 or 2). If desired you may actuate fast-forward, rewind, program selector or eject at any time during play (see each item). With auto-reverse, the cassette will

play continuously changing sides automatically until you eject the cassette.

#### **11. CASSETTE EJECT**

The cassette tape is not ejected automatically when switch is off. This unit is still workable and does not damage the deck mechanism while tape is placed in the cassette tape door.

However, it is recommended to push the eject button and take out cassette tape to avoid any damage on deck mechanism.

#### **12. LOCKING FAST-FORWARD/REWIND CONTROLS**

To rapidly advance or rewind tape, depress the appropriate button until it locks in place. To stop fast-forward depress either rewind or eject slightly. To stop rewind, depress fast-forward or eject slightly.

#### **13.,14. PROGRAM SELECT/PROGRAM LIGHTS**

While playing a cassette you may desire to manually change sides before the completion of one side of play. To do this simply depress and release the program button. You will find that one program indicator light will go out and the other will illuminate. These arrows indicate tape direction.

#### **15. CASSETTE DOOR**

The cassette should be checked to assure that the tape is tightly wound on the spools before inserting. To operate cassette player properly, insert cassette so the open edge of the cartridge faces the cassette door.

#### **16.,17. HOURS ADJUST BUTTON MINUTES ADJUST BUTTON**

To adjust hours, push this button with a toothpick or similar object. "Hours (Minutes)" will start to count up, then release it at correct hours, or flick this button to advance hours (minutes) one by one to the exact hours.

#### **18. CLOCK DISPLAY PANEL**

#### **19. CLOCK RECALL SWITCH**

You can read Time of Day at a glance by pressing this knob even is the ignition key has been switched off.

# AUDIVOX AM/FM/STEREO CASSETTE PLAYER (ELECTRONIC TUNE) WITH EQUALIZER

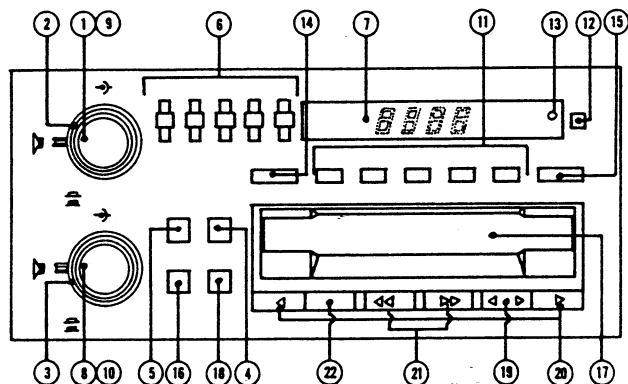

1. **ON-OFF SWITCH/VOLUME CONTROL**  
To provide power to the unit, turn this control knob clockwise until a slight "click" is heard. To increase volume, continue rotating the knob to desired level.
2. **LEFT-RIGHT BALANCE CONTROL**  
To balance sound from left to right, rotate rear knob as desired.
3. **FRONT-REAR BALANCE (FADER) CONTROL**  
This control allows you to balance the output between the front and rear speakers. When used in conjunction with the LEFT/RIGHT BALANCE CONTROL, you have full 4 way stereo balance capability.
4. **LOUDNESS CONTOUR SWITCH**  
When listening to music at low volume levels, this switch should be depressed so as to boost the bass and treble tones slightly and compensate for the characteristics of human hearing.
5. **PWR SWITCH**  
Press this button to boost the output power.
6. **5-BAND GRAPHIC EQUALIZER**  
5-Band equalizer controls, five slide bar controls, have been built into this unit for total control of the entire audio reproduction range. These controls will vary the tone range from bass through treble with the bass controls at the left, the mid-range controls in the center, and the treble controls at the right. As tone quality is a matter of

individual taste, we recommend starting with all five controls at the mid-position, and then adjusting each to your personal preference.

Moving the control upward will emphasize that particular tone range, while moving it down will de-emphasize that range. A visual inspection of the five controls will provide a graphic illustration of the actual response curve showing which ranges are emphasized and which are de-emphasized. Each slide control is capable of varying the response from the mid-position (FLAT) setting upward by 12 dB or downward by 12 dB, for a total variation of 24 dB.

7. **DIGITAL DISPLAY PANEL**  
This panel displays radio frequency with "AM" or "FM", time with "AM" or "PM", and "ST" if you select a stereo station. The AM radio indicator is used for AM (Ante Meridiem) indicator in Time mode.
8. **AM-FM BAND SELECTOR**  
For AM-FM Band selection, lightly depress the button. The letters AM or FM will appear on Display Panel according to your selection.
9. **RADIO CALL (PUSH)**  
Push the button in order to display the tuned frequency on the Display Panel (7), then it displays the frequency for approximately 8 seconds.
10. **MANUAL TUNING CONTROL**  
To manually select a radio station, rotate the knob clockwise. The radio will advance one digit higher. If you hold the knob in, it will rapidly advance digits until released. To tune downward, rotate the knob to counter-clockwise.
- 11.,12. **DUAL AM-FM PRESET BUTTON (11) & MEMORY ENABLE BUTTON (12)**  
To pre-set memory buttons:
  1. Turn the unit on and select AM band.
  2. Select first station to be pre-set using either manual tuning or Auto Search (with Scan Button or Seek Button).
  3. Depress Memory Enable Button (12). MEMORY ENABLE INDICATOR (13) will illuminate.
  4. Depress the first button to be pre-set within 8 seconds. The memory light will go out indicating the first station is pre-set.

5. Repeat for remaining four buttons. Now switch to FM band and re-set all five buttons for FM stations in the same manner. The circuitry in the memory systems allows you to pre-set up to 10 stations (5 AM, 5 FM) using only five buttons.

NOTE: The memory system will be erased should the battery be disconnected for any reason.

**13. MEMORY ENABLE INDICATOR (RED)**

**14. SCAN BUTTON**

Pressing this button will start to scan frequencies. The unit stops searching and receives the broadcast for about 8 seconds. If you wish to listen to this broadcast, depress this button again within these 8 seconds. If the button is not depressed, the unit will start to scan again after 8 second interval. You can stop search operation anytime by pressing this button again while scanning.

**15. SEEK BUTTON**

Press this button to search the desired station automatically. If you wish another station, press it again while receiving a station. If you press this button while searching, search operation is stopped at once.

**16. DNR SWITCH**

Depress the DNR button when you hear the hissing sound of the tape playback of background noise of the radio. The incorporated DNR circuit will eliminate such irritating noises and ensure best sound listening without affecting high sound quality of the music.

**17. CASSETTE DOOR**

The cassette should be checked that the tape is tightly wound on the spools before inserting. To properly insert the cassette, hold it so the exposed tape edge faces the door. Insert tape into opening. Depress fully until cassette is engaged and mechanism starts playing.

**18. METAL TAPE SELECTOR**

During tape operation this switch functions as a Metal Equalization Switch. The unit incorporates a special hard permalloy tape head designed for excellent fidelity from all cassette tapes and this special selector allows the use of hi-fidelity metal cassette tapes.

When using normal cassettes (Fe, FeCr types), place the switch in the "out" position. Always position the switch to the proper setting before inserting a cassette.

**19. PROGRAM SELECTOR**

Push this button to change the program (i.e., the direction of tape running). Program is automatically reversed at the end of tape.

**20. PROGRAM INDICATOR**

While tape is being played, one of these indicators will light up to indicate the direction of tape running.

**21. F.F BUTTON/REW BUTTON**

During tape playback, you can rapidly move the tape either forward or backward.

These two buttons have double arrow signs which indicate opposite directions to each other.

Take the button of the 'same' arrow direction as the illuminated Program Indicator, which acts as Fast Forward Button.

Take the button of the 'opposite' arrow direction as the illuminated Program Indicator, which acts as Rewind Button.

To fast forward the tape, fully depress the Fast Forward Button, and to resume normal play lightly press the other until it disengages. To rewind the tape, fully depress the Rewind Button, and to resume normal play lightly depress the other till it disengages.

**22. EJECT BUTTON**

Playback is stopped and cassette is ejected by pressing this button, which also has the function of switching over to radio operation.

**23. TO SET TIME:**

1) Make sure that the display panel (7) is in Time Mode. (If it indicates frequency, wait for maximum 8 seconds until it turns to indicate Time.)

2) Depress the Memory Enable Button (12) and keep depressing during the whole procedures of time adjustment.

3) Rotate the Manual Tuning Knob (10) clockwise to adjust minutes.

4) Rotate the Manual Tuning Knob (10) counterclockwise to adjust hours. To adjust AM and PM indicators, adjust hours by 12 hours.

5) When the above adjustments have been finished, release the Memory Enable Button.

# SEAT AND DOOR PANEL CONTROLS

## ENTRANCE DOOR LOCK - A and C Body Coach and A-Body w/Driver Side Entrance Door Option

The entrance door can be locked or unlocked from outside the vehicle by inserting the key in the lock and turning. To lock the door from inside, slide the lock button to the right. Lubricate the lock periodically with graphite to keep it in good working condition.

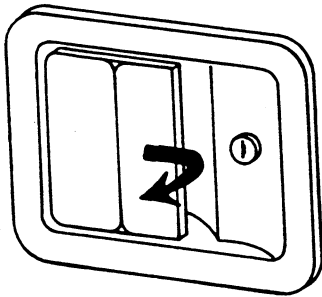

## EXTERIOR ENTRANCE DOOR HANDLE

## ENTRANCE DOOR HANDLE

The entrance door can be opened from outside the vehicle by pulling the door handle outward. To open the door from inside, pull upward on the door handle. When the door is locked, neither the inside or the outside door handle can be operated.

### CAUTION

Do not force the inside door handle down, as damage could occur.

The bolt lock is for added security and should be used as a security night lock.

### CAUTION

When releasing security night lock, be sure to retract the bolt before opening door latch to prevent drag on the bolt pin. Instruct all passengers in the operation of this door catch system as well as the emergency exit window on pages 38 and 39.

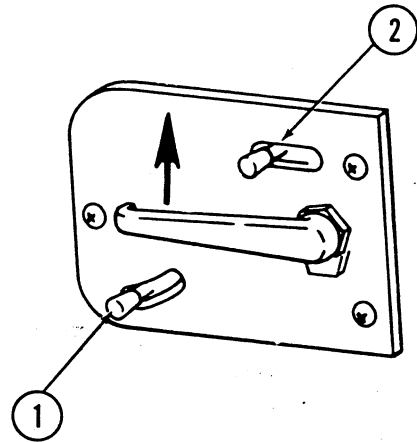

## INTERIOR ENTRANCE DOOR HANDLE

1. Door Lock
2. Bolt

## DRIVER COMPARTMENT DOOR LOCK (C-Body Only)

The driver's compartment door can be locked from inside the vehicle by depressing the door lock buttons located on the upper door panel. The doors can be locked and unlocked from outside the vehicle with a key. The doors can also be locked by simply depressing the inside door lock button and closing the door.

## IMPORTANT

The keys should always be removed from the motor home when leaving the vehicle. Since the doors can be locked without the keys, make sure they have been removed from the ignition before locking the driver's compartment.

## SEATS

The driver and front passenger seats can be independently adjusted to suit each individual's preference. To move the seat forward or backward, simply move the slide release lever, located under the front of the seat, to the left and exert slight body pressure in the direction desired.

The seats can be swiveled to provide easy entrance and exit. The swivel feature also allows the seats to be turned toward the living area for extra seating when the unit is parked. To swivel the seats, press the release lever, located on the right side of the seat, to the rear and rotate the seat with body pressure. The seats are designed to lock only when returned to the forward facing direction.

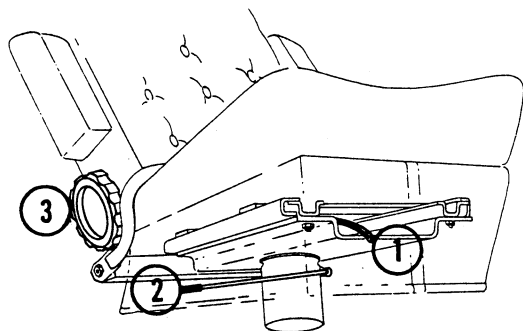

## DRIVER AND PASSENGER SEAT

1. Slide Release Lever
2. Swivel Release Lever
3. Reclining Knob

### WARNING

Do not adjust the drivers seat while vehicle is in motion.

After adjusting the seat, always use body pressure to make sure the slide and swivel mechanisms have engaged.

The seats on some A-Body and some C-Body motor homes include a tilting mechanism which permits the seat to be reclined. To tilt the seat back, rotate the black knob on either side of the seat, to the rear and the seat will recline as far as you turn the knob. To raise the seat, lean slightly forward and rotate the knob forward and the seat will return to its former position.

## OPERATION OF SQUARE BACK, BUCKET SEAT YOUTH BED

Rotate passenger seat to face the rear of the unit. Slide the drivers seat to the rear and rotate to face the drivers door. Lower the back of the drivers seat until it is even with the passenger seat. At this time insert the wedge into the space in drivers seat and the youth bed is complete.

## SEAT ASSEMBLY ARM REST ADJUSTMENT

The seat assembly arm rest may be adjusted to alter the angle at which the arm rest will remain when placed in the lower position. To reposition the arm rest angle, proceed as follows:

1. Unzip the arm rest cover fabric at the rear of the arm rest assembly.
2. Carefully force the foam cushion material away from the inside bottom edge of the arm

rest frame. This will allow access to the allen head adjustment screw mounted on the bottom portion of the arm rest frame assembly.

3. Adjust the screw clockwise to lower the arm rest angle. Adjust the screw counterclockwise to raise the arm rest angle.

NOTE: The arm rest may be raised to provide easier access for adjustment.

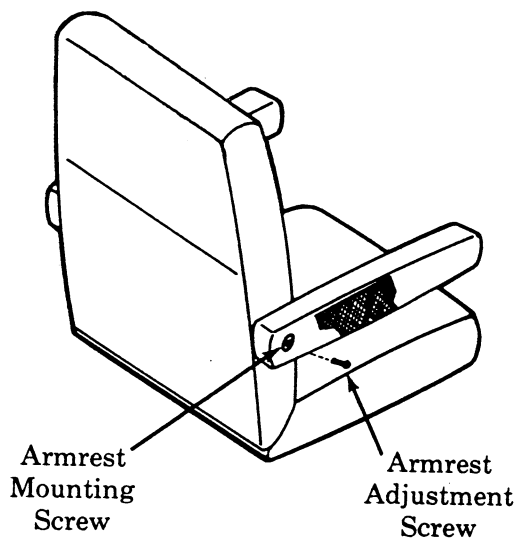

## SEAT BELTS

The driver and passenger seat and all seats in the motor home designated to carry passengers while the vehicle is in motion are equipped with seat belts. These are installed for the protection of the driver and all passengers and must be fastened whenever the vehicle is in motion. The lap belts must be worn as low as possible and fit snugly across the hip area. Always sit well back and erect in the seat.

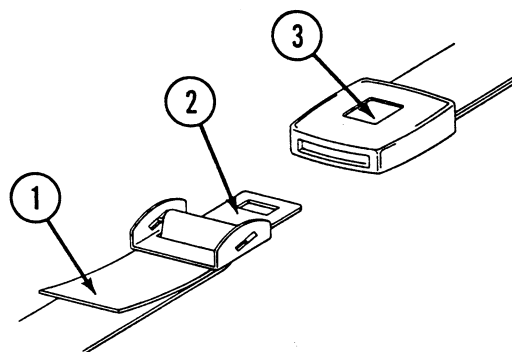

## SEAT BELT

1. Adjustment Strap
2. Tongue
3. Release Button



**Adjustment:** To lengthen belt, turn tongue at a right angle to belt and pull to desired length. To shorten, pull loose end of belt.

**To Fasten:** Be sure belt is not twisted. Grasp each part of the belt assembly and push tongue into buckle. Adjust to a snug fit by pulling the loose end away from the tongue.

**To Unfasten:** Depress button in center of buckle and slide tongue out of buckle.

### WARNING

Snug and low belt positions are essential. This will ensure that the force exerted by the lap belt in a collision is spread over the strong hip area and not across the abdomen, which could result in serious injury.

Only seats equipped with seat belts are to be occupied while vehicle is in motion. Seats not equipped with seat belts will be labeled: "This seat not intended for occupancy when vehicle is in motion".

## SHOULDER BELTS (Canadian C-Body Units Under 10,000 lbs. only)

Your vehicle may be equipped with one set of lap-shoulder safety belts for each of the two front seats. Before attempting to fasten the belt, always adjust the seat to fit you properly and sit up erect and well back into the seat.

**Fastening** - Hold the belt just behind the tongue using the hand nearest to the door. Next, bring the belt across your body and slide the tongue into the buckle until the latch engages.

**Unfastening** - Press the release button in the buckle. Hold onto the tongue when you release it from the buckle as it is designed to retract automatically.

When the lap-shoulder belt is in use, the lap portion must ride across the strong hip area and the shoulder portion must ride diagonally over the shoulder blade toward the buckle.

### WARNING

To minimize the chance or extent of injury in a collision, wear the shoulder

belt only in the position previously stated.

The shoulder belt is designed to lock only during a sudden stop, sudden body movement or a collision. At all other times it will move freely with the occupant.

### WARNING

An improperly worn safety belt may introduce an element of risk. Make sure that it is not slack when worn. If the front safety belts in your vehicle are the type with an anchorage on the inside of the door sill, make certain that the pivoting arm is always facing forward in the direction of the belt and never facing to the rear. Safety belts must be free of twists if they are to function correctly. Always make certain that the safety belts work no matter what type your vehicle is equipped with.

A tight fit with a lap safety belt positioned low on the hips is required to aid in lowering the chance or severity of injury in a collision. This puts the force of the belt over the hipbones rather than across the abdomen. Always set completely back and erect in the seat. To implement full protection of the safety belt, never allow more than one occupant to use the same safety belt at any one time, and do not let the safety belts become damaged by pinching them in the doors or in the seat mechanism. After any serious accident, any safety belts which were in use at the time should be replaced.

Any use of safety belts by pregnant women should first be approved by your doctor, due to the fact that this could constitute a dangerous condition.

Children in vehicles **should be restrained** to help lower chance and/or severity of personal injury in accidents or sudden maneuvering

**A child restraint system can help protect a child in a vehicle. Look for the following items when purchasing a child restraint system.**

1. It must have a label certifying that it meets applicable Federal Motor Vehicle Safety Standards (FMVSS) or in Canada, requirements of the Children's Car Seats and Harnesses Regulations (CCSHR).

2. Be certain that the restraint system will attach easily and securely to your vehicle, restrain the child securely, and still be convenient enough that you will install it correctly each time it is used.
3. Be certain the restraint system is appropriate for the child's height, weight and development. The label required by the standard or regulation, or instructions for infant restraints, typically provide this information.
4. Review the instructions that come with the restraint system. Be certain that you understand them and can implement the restraint system properly and safely in your vehicle.
5. When using any child restraint system be certain to read and follow all instructions on installation and use that come with the restraint system.

# TRAVELING WITH YOUR MOTOR HOME

## PRE-TRAVEL CHECK LIST

Before starting the engine in preparation for an outing, be sure your motor home has been properly prepared and maintained. This will ensure an enjoyable trip and help avoid delays. Use this checklist as a guide.

- Fluid Levels - Check and fill if necessary; engine oil, transmission, power steering, radiator, brake, battery and windshield washer.
- Wheel Lug Nuts - Check for tightness.
- Tires - Check for proper cold inflation pressures as specified in pressure chart.
- 110-Volt Generator (Optional) - Check oil level in generator engine.

### WARNING

Never check oil level in generator while engine is operating.

- Fire Extinguisher - Make sure it is fully charged and secured in mounting bracket.
- Lights - Make sure all exterior lights operate.
- Exterior Door and Step - Make sure doors are closed, locked and step retracted.
- Sewer and Water Supply Hose - Unhook and store.
- Loose Items Inside the Motor Home - Store or secure items.
- Pilot Lights - Make sure all pilots are off.
- Fuel Tanks - Check level.
- Water Tank - Fill with fresh water.
- LP Gas Tank - Make sure valve is closed and door latched securely.
- Seats - Adjusted for comfortable position and locked in place.
- Mirrors - Adjust for maximum visibility from driver's seat.
- T.V. Antenna - make certain the T.V. antenna is lowered and seated in its' support cradle.

## CARBON MONOXIDE WARNING

### WARNING

Avoid inhaling exhaust gases, as they contain carbon monoxide, which by itself is colorless, odorless and poisonous.

If you suspect that exhaust fumes are entering the passenger compartment, have the cause determined and corrected as soon as possible. If you must drive under these conditions, drive only with **ALL WINDOWS FULLY OPEN**.

The best protection against carbon monoxide entry into the vehicle body is a properly maintained engine exhaust and ventilation system. It is recommended that the exhaust system and body be inspected by a qualified motor home service center.

- Each time the vehicle is raised for oil change.
- Whenever a change is noticed in the sound of the exhaust system.
- Whenever the exhaust system, underbody or rear of the vehicle is damaged.

To allow proper operation of the vehicle's ventilation system, keep front ventilation inlet grill clear of snow, leaves or other obstructions at all times.

**SITTING IN A PARKED VEHICLE WITH ENGINE RUNNING FOR AN EXTENDED PERIOD IS NOT RECOMMENDED.**

Do not run engine in confined areas such as garages except to move vehicle in or out of area. When vehicle is stopped in an **UNCONFINED** area with the engine running for any more than a short period, adjust heating or cooling system to force outside air into the vehicle.

1. Set fan to medium or high speed and vent control to "air".
2. On vehicles equipped with air conditioning, set fan to medium or high speed and set control to obtain maximum vent air.

Doors and rear windows should be closed while driving to avoid drawing dangerous exhaust gases into the vehicle.

## EQUIPPING FOR TRAVEL

When beginning a trip; several items should be taken in addition to the basic clothes, food and recreational items. A checklist is provided for

your convenience. Remember, it is important to distribute weight and store all heavy items near the floor.

### EMERGENCY EQUIPMENT CHECKLIST

- Flashlight
- First Aid Kit
- Road Emergency Flares
- Tool Box with Assortment of Hand Tools
- Plastic Bucket
- Tow Chain or Rope
- Wheel Blocks for Leveling or Extra Jacks
- Water Hose
- 100-150 feet of 3 Wire Electrical Cord with at least 30 Amp Capacity.
- Fire Extinguisher
- Hydraulic Jack and Lug Wrench
- Spare Tire

### QUICK LOADING CHECKLIST

#### LINENS

- Sleeping Bags
- Sheets
- Pillow Cases and Pillows
- Mattress Pads
- Extra Blankets
- Laundry Bags

#### COOKING

- Can Opener
- Bottle Opener
- Aluminum Foil
- Matches
- Plastic Bags
- Coffee Pot
- Storage Dishes

#### CLEANING

- Scouring Pads
- Cleanser
- Dish Soap
- Sponge
- Laundry Soap
- Cleaning Rags

#### BATHROOM

- Hand Soap
- Bath Towels that can double as beach towels
- Toilet Kits
- Shaver
- Toilet Tissue (RV)

#### BABY NEEDS

- Porta-Crib
- Car Bed

#### PERSONAL

- Credit Card
- Traveler's Checks
- Money
- Driver's License
- Proof of Citizenship for Canadian or Mexican Crossing
- Sun Glasses

#### PET NEEDS

- Food
- Leash
- Water and Food Dishes
- Proof of rabies shots

#### MISCELLANEOUS

- String
- Clothes Line
- Insect Repellant
- Masking Tape

#### FOOD

Enough for first couple of days or so - buy as you go. Use plastic, paper or other disposable containers. Remember seasoning.

#### CLOTHES TIPS

One "good" outfit for each traveler (hang in plastic bag in closet). Remember - it can get cold in the mountains, even during summer. Send for information on the area you are going to visit and plan accordingly.

#### EMERGENCY EXITS

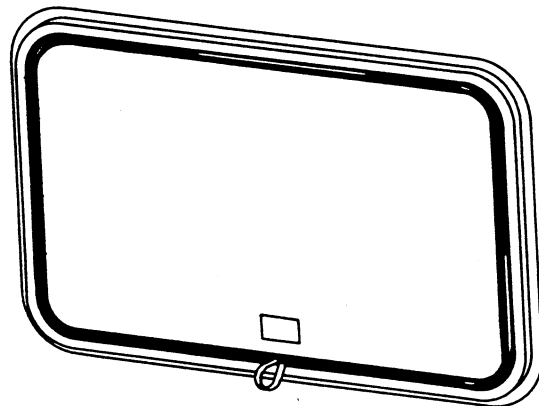

#### Emergency Exit Window

Your motor home may be equipped with the one piece stationary window at the rear or side of the motor home which functions as an escape exit in an emergency situation. The glass is installed with a rubber extrusion and is removed by pulling on the plastic ring until the rubber

cord is completely removed; then pushing the window out. The instructions for removal are also located on a label on the glass for quick referral and for passengers who may not be familiar with the exit. Be certain the label is not removed.

### **CAUTION**

Use the window for emergency exit only. Do not test for proper operation.

If the cord is released by accident, but the glass does not fall out, the cord can be replaced using a blunt instrument, preferably one made of plastic. We suggest you contact a Winnebago or Itasca dealer for assistance.

### **WARNING**

Use care when exiting emergency window, as broken glass may be present in the exit area.

### **Use of Slider Windows as Emergency Exits**

Most single and double slider windows along the side of the motor home can also be used as emergency exits, should the need arise. To use the windows as exits, slide the window open, then strike the screen near one corner to loosen it and push out.

### **LOADING THE MOTOR HOME**

When loading the vehicle, it is important that the load be properly distributed over both the front and rear axles within the GAWR (gross axle weight rating) limits. Note that the total of both GAWR figures may exceed the GVWR (gross vehicle weight rating) listed on the certification label. Therefore, both axles must not be loaded to maximum capacity, or the GVWR may be exceeded. If the vehicle weight is greater than capacity, remove unnecessary cargo.

It is recommended that before loading, each axle and wheel/tire weight be determined by weighing each location separately with the vehicle fuel tank, LP tank and water tank full, but without passengers and cargo.

Load the heavier items low and toward the lighter side to distribute the weight as equally as possible from side to side. It is possible for the GAW (gross axle weight) of an axle to be below capacity and still experience poor vehicle handling if more of the weight is on one side. Gross wheel weight ratings can be obtained by dividing the GAWR figures in half.

Always maintain tire inflation pressure at the designated value specified in the tire inflation chart. Check pressures after the motor home has been parked overnight and before driving any great distance. Check tire pressure again anytime the load is increased.

### **WARNING**

Total loaded motor home weight including options, attachments, personnel, water and waste must not exceed the GVWR or the gross axle weight rating (GAWR) of either axle.

### **WEIGHING THE MOTOR HOME**

The frame and load carrying components of your motor home have been designed to provide satisfactory service as long as the vehicle is not loaded in excess of the gross vehicle weight rating (GVWR) or the gross axle weight rating (GAWR) for the front and rear axles. These ratings are listed on the "vehicle certification" label located on the driver's sidewall to the left of the dash on all A-Body motor homes and on the cab body just above the door striker on all C-Body motor homes. The GVWR is the total permissible weight of the motor home, including driver, passengers, the vehicle itself with all options, and the load it is carrying, including all liquids. The GAWR is the total permissible weight allowable for each axle.

Weigh the motor home periodically at any state weighing scale or at a local weighing station. The front and rear axles must be weighed separately with the vehicle fully loaded (including occupants) and ready for operation. This process will determine the actual gross axle weight (GAW) for front and rear axles. Next, weigh the entire motor home fully loaded, or add the front and rear gross axle weights to determine the gross vehicle weight (GVW). The GVW or actual weight of the vehicle must never be allowed to exceed the GVWR, nor should either of the GAW's be allowed to exceed the GAWR figure. Overloading the vehicle can produce safety hazards, poor handling and also reduce the life of all load carrying components such as tires, springs, shock absorbers, etc.

### **IMPORTANT**

The vehicle must be level when weighing either of the axles and when weighing any of the wheel locations separately.

The accompanying figure illustrates a typical vehicle in the loaded condition. Note that the front and rear GAWR's and the GVWR are not exceeded.

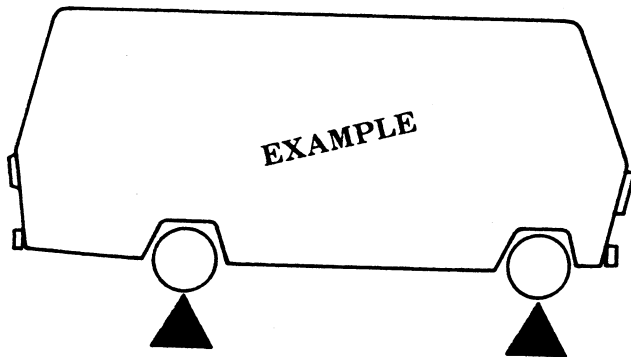

MAXIMUM GVWR - 12,300 lbs.  
 FRONT GAWR - 4,880 lbs.  
 REAR GAWR - 7,500 lbs.

Rear Curb	5480 lbs.
Rear Cargo and Passenger Load	<u>1190 lbs.</u>
	6670 lbs.

Front Curb	3820 lbs.
Front Cargo and Passenger Load	<u>790 lbs.</u>
	4610 lbs.

Total Weight at Ground 11,280 lbs.

## ROOF LOADING

The roof on most models of motor homes is capable of carrying some lightweight articles while the vehicle is in motion. However, maximum weight being carried while the vehicle is in motion is not to exceed 10 pounds per square foot or a maximum of 100 pounds. A roof mounted luggage carrier designed for this purpose is available from your dealer.

Design and weight distribution considerations limit the use of the roof for storage on some models. Luggage carriers or other articles should not be placed or mounted on roofs and these vehicles. Refer to the "Roof load" capacity in the specifications on pages 7-9 for your model before loading the roof.

When the vehicle is stationary, a cargo load of 100 lbs. plus the weight of a 225 lb. person to load the cargo or to conduct inspection and maintenance is permissible.

## WARNING

Roofloading is not allowed on certain vehicles. Refer to the specifications for the allowable load on your vehicle.

Weight added to both the roof and the trailer hitch contribute to the gross vehicle weight, which must not exceed the vehicle's GVWR.

Total weight added to the roof, hitch and bumper must not exceed 250 pounds.

NOTE: Total weight does not include the weight of the optional 110-Volt roof air conditioner.

## TRAILER TOWING

Since your motor home was designed and intended to be used primarily as a load carrying vehicle, it is not recommended that it be used for trailer towing, as handling, durability and economy will all be affected. Maximum safety and satisfaction when towing depend on proper use of correct equipment and adherence to certain limitations.

It is important that the trailer tongue load be maintained at approximately 10 percent of the loaded trailer weight, not to exceed a tongue load indicated in the specifications for your vehicle. Tongue loads can be adjusted by proper distribution of the load in the trailer.

An auxiliary transmission oil cooler connected in series with the radiator bottom tank cooler is mandatory for trailer towing.

## CAUTION

It is essential that the auxiliary cooler installation does not create and oil flow restriction to the transmission cooling system.

## WARNING

Do not install a frame equalizing type hitch on your vehicle.

Before descending a steep or long grade when towing a trailer, reduce speed and shift into a lower gear to control vehicle speed. Avoid prolonged or frequent application of the brakes which could cause overheating.

The maximum permissible weight of any towed vehicle must not exceed the weight indicated in the specifications for your vehicle. Trailers weighing in excess of 1000 lbs. require trailer brakes. The weight of the fully equipped motor home with passengers plus the weight on the hitch of the trailer with cargo, must not exceed the gross vehicle weight rating (GVWR) of the motor home. See "Weighing the Motor Home" on pages 39 and 40.

## **WARNING**

Engine, drive train and option combinations may limit the installation or use of a trailer hitch on your vehicle. Refer to the "Hitch Capacity" as indicated in the specifications or label located on the backwall.

# DRIVING TECHNIQUES

## FILLING FUEL TANK - GASOLINE ENGINE

When filling the fuel tank, allow fuel to enter the tank until the automatic pressure regulator on the gasoline pump activates and stops the flow of fuel, indicating a full tank. This provides a predetermined vapor space at the top of the tank to allow for expansion of the fuel. Filling above this level may cause fuel to be forced out through the fuel tank vent due to internal expansion, especially on warm summer days.

### WARNING

All pilot lights and appliances must be turned off when refilling the fuel tank or the LP tank. Do not attempt to overfill the fuel tank. Overfilling may create a fuel overflow and risk of fire.

## FILLING FUEL TANK - DIESEL ENGINE

When filling up the fuel tank, make certain that no water accidentally enters the tank. The filler cap and the surrounding area should be clean and free of dust. When filling up the tank, allow fuel to enter the tank until the automatic pressure regulator on the fuel pump activates and stops the flow of fuel, indicating a full tank. This provides a pre-determined vapor space at the top of the tank to allow for expansion of the fuel. Filling above this level may cause fuel to be forced out through the fuel tank vent due to internal expansion, especially on warm summer days.

Diesel fuel may foam up when filling the tank. This may cause a false reading on the pump's automatic pressure regulator resulting in a partially full tank even though the pump has shut off.

### CAUTION

Use of any fuel or additives not recommended by Winnebago Industries, Inc., could cause damage to the diesel engine. Be careful not to run out of diesel fuel due to the fact that it is difficult to start the engine after refueling an empty system and may require bleeding air from injectors.

If this occurs, take care not to crank the starter for more than fifteen seconds at a time. Allow 1 minute between crankings to allow the starter to cool off. Cranking the starter for longer periods of time may result in serious damage to the starter.

### WARNING

All pilot lights and appliances must be turned off when refilling the fuel tank or the LP tank. Do not attempt to overfill the fuel tank. Overfilling may create a fuel overflow and risk of fire.

## WATER IN FUEL INFORMATION -DIESEL ENGINE

### W/ICN26RB, W/ICN26RH and W/ICN27RU ONLY

When filling the fuel tank, it is possible for water to be pumped into your fuel tank along with the diesel fuel. Your motor home has been equipped with a water separator system and two additional fuel filters. The primary fuel filter is located beneath the passenger side of the front deck and the secondary fuel filter is located beneath the air cleaner. Your motor home is also equipped with a "Water in Fuel" indicator light at the instrument panel which will illuminate if water is present in the fuel system.

If the light illuminates or you notice a loss of power or rough engine operation, have the water drained from the fuel system. The presence of water in the fuel system could result in failure or extensive damage of the fuel injection system.

If the indicator light illuminates immediately after filling the fuel tank and before the motor home has been driven, it indicates that a large amount of water has been pumped into the tank. Turn off the engine and immediately purge the fuel tank. If the indicator light illuminates when turning or braking, have the fuel system inspected and purged as soon as possible.

## TRAVEL TIPS

As you travel around the country in your motor home, you will pick up various tips from other motor home owners.



A number of tips can also be picked up by reading articles and regular columns in some of the outdoor and camping magazines. Some magazines and publishing companies print an annual park and campground directory. These can be found at your local newsstand or trailer supply dealer. Following are just a few travel tips to start out with.

1. Be sure to always check for sufficient clearance. Remember the height and width of your unit.
2. Taste the water before filling the water tank in an unfamiliar location. The water in some areas contains a salt or a sulfur taste.
3. Never use a new hose to fill the water tank. It leaves a distinct taste.
4. Showers can take a lot of water. Conserve water by taking a "SEASHOWER". This is done by: wetting down, turning off the water, soaping thoroughly and then rinsing.
5. Dump sewage only at approved dumping stations.
6. Store liquids in plastic containers with tight fitting caps to prevent spills.
7. Keep an eye on the water and holding tank levels. It is a good idea to dump the holding tank at least every two days.
8. When traveling with children, it is helpful to plan their wardrobe for a week. Place each day's clothing in a plastic bag and label the bag with the child's name and day of the week for use.
9. Use sleeping bags whenever possible. They save laundry and take up less storage space than bedding.
10. Make sure all compartment doors have been closed and the door step has been stowed in the correct position before moving the vehicle.
11. Before traveling, make sure the refrigerator door has been secured. Use care when opening the refrigerator door after the vehicle has been stopped. Any articles that have shifted may fall out when the door is opened.
12. During peak tourist season and holidays, it is best to phone ahead and make reservations at the park where you plan to stop.
13. Some states or cities will not permit you to pass through highway tunnels because of the LP gas containers in your vehicle. If your route includes a tunnel, check with the highway patrol or department of highways before venturing forth.
14. Do not leave food or odor causing material in your vehicle for extensive periods of time. Always allow damp clothing, hunting gear,

etc., to dry before putting it away.

15. Become familiar with the fire extinguisher and make sure it is always fully charged. Remove and replace it and read the instructions so you know the correct operating procedure before an emergency.
16. Make a list of all groceries, fresh meats, vegetables, newspapers, etc., that you may need and try to pick them up during your last fuel stop of the day. This will prevent leaving a good parking spot once you have arrived at your destination.
17. When you sit over the front wheels while driving, as in the motor home, you have a tendency to crowd the middle of the road. Check the rear view mirror frequently to observe how close you are driving to the center line.

## WINTER CAMPING TIPS

Since motor home use has extended beyond the warm summer months and on into the ski and snowmobile season of winter, the following winter use tips may help make your winter motor home travel more enjoyable.

1. Cut out transparent heavy plastic sheets and attach to the inside of the window with duct tape.

### WARNING

Never cover the emergency exit window when winterizing.

2. The holding tank and plumbing system are the most vulnerable parts of the motor home in winter. Exposed piping, etc., can be wrapped with heat tape and covered with insulation and plastic to keep out air and moisture. This same procedure can be used to a limited extent on holding tanks. The best protection for holding tanks is the use of nontoxic antifreeze and limited use of the drainage system.
3. Cover vinyl seats and cushions with towels to absorb cold air.
4. Place newspaper under the entrance door throw rug to soak up melting snow.
5. Position throw rugs against the bottom crevice of the entrance door to cut off cold air blowing in from the outside.
6. Place an old rug outside the motor home and another inside to prevent snow and moisture from being carried inside.

7. Carry an adequate supply of LP gas. A partially filled tank may last only a short time.
8. Carry a can of lubricant or graphite to protect against frozen locks, etc.
9. Try to keep a window partially open to prevent carbon monoxide buildup inside the motor home. Roof vents can easily become covered with snow.
10. For added warmth, insulate the window side of the drapes.
11. A temporary skirting can be made by piling snow up along the lower edge of the motor home to keep air from blowing under the unit.
12. Make sure all heating ducts are clean and lint free. Clogged ducts can restrict air flow and, in some cases, are a fire hazard.
13. To help eliminate low battery and difficult starting during cold weather, place a thick rubber pad under the batteries. This will help prevent cold temperature transfer from the steel support plates to the base of each battery.

## FIRE EXTINGUISHER

The dry chemical fire extinguisher is conveniently located near the entrance door area on both A-body and C-body motor homes.

It is highly recommended that you become thoroughly familiar with the operating procedure as displayed on the side of the extinguisher and that the extinguisher be inspected at least once a month in accordance with National Fire Protection Association (NFPA) recommendations as stated on the label.

Before beginning a vacation or any extending trip, it would be most beneficial to instruct all passengers on the use of all safety devices contained within the motor home including the location and operation of the fire extinguisher.

### WARNING

Monthly, and before beginning a vacation trip or any extended motor home travel, it is strongly recommended that the fire extinguisher be checked for proper charge and inspected to assure proper operating condition.

## FLASH FLOOD AND SEVERE WEATHER SAFETY

Motor home travelers and campers often seek the out-of-the-way secluded areas for weekend recreation or extended summer vacations.

One of the more serious conditions affecting the motor home traveler and camper is that of the "Weather". Should you desire the high mountain terrain, the lower desert and flatland or the plain country of the midwest, the weather is always with you and subject to change, sometimes with little or no notice, but usually with adequate warnings broadcast over local radio and TV stations.

Many recreational areas are vulnerable to severe weather situations, especially flash flooding conditions. A few simple precautions may help lessen the hazards of flash flooding or reduce your immediate involvement.

### IMPORTANT

It is recommended that all motor home occupants become familiar with these safety precautions, and be constantly alert for any changes in the weather.

- Be alert, keep an eye to the sky because thunderstorms can form at any time in any month of the year. Thunderstorms can produce heavy amounts of rain over a small area in a short time which may result in a flash flood. Listen frequently to weather reports on radio for weather and flood conditions.
- When camping near a stream, leave plenty of sloping bank between you and the stream.
- Avoid deep canyons and dry washes during stormy or threatening weather (constantly be alert for alternate exits).
- If heavy rain occurs, move to high ground immediately (at least 30-40 feet above the canyon floor or bottom of dry wash).
- During a flash flood, if you can't move your vehicle, abandon it. Don't attempt to return to your vehicle before the water has receded.
- Don't attempt to wade to your vehicle if the water is above your knees - fast moving water exerts an enormous amount of pressure, making it impossible to remain standing or walking.
- Don't try to drive through flooded areas.

- Follow instructions of local authorities. Leave immediately when advised to do so. Many lives have been lost because people didn't heed warnings.
- Have on hand survival supplies for several days, including food, water, first aid equipment and necessary medications. In desert areas during hot weather allow 3-4 gallons of drinking water per day, per person.
- Before you leave home, inform someone of your destination and when you expect to return. Authorities at your destination should be notified immediately if you do not return on time.

#### **REMEMBER THESE TERMS:**

**Flash Flood Watch:** Heavy rains may result in flash flooding in the specified area. Be alert and prepare for possibility of a flood emergency.

**Flash Flood Warning:** Flash flooding is occurring, or is imminent in certain areas. Move to safe ground immediately.

It is highly recommended that the motor home operator obtain a weather radio. These radios offer up to date weather condition broadcasts. During good weather, the latest observations and forecasts are tape-recorded by local Weather Service offices in messages that last from three to five minutes. These messages are replayed continually 24 hours a day.

The tape-recorded messages are revised every three to four hours, or more frequently when appropriate. When severe weather threatens, forecasters at the local Weather Service office interrupt the broadcasts with storm warnings,

either tape-recorded or "live" as the situation demands.

The frequencies used for NOAA Weather Radio, (National Oceanic and Atmospheric Administration), nationwide, are 162.40, 162.475 or 162.55 megahertz.

#### **NIGHT TIME DRIVING**

Make sure all running lights and signal lights are clean and in working order. Periodically have your head lights checked and adjusted.

Although cars can tell when they are clear of you when they pass; longer vehicles, such as motor homes have a more difficult time making judgement. Use care when passing other vehicles. Have occupants assist in observing traffic and the vehicle being passed.

#### **MOUNTAIN DRIVING**

Special techniques must be used when driving in mountainous or hilly country. When ascending upgrades the transmission will automatically drop into a lower gear. If the grade of the incline is constantly changing and the automatic transmission is repeatedly upshifting and downshifting, it may be advisable to select the lowest adequate gear range for the duration of the incline.

#### **CAUTION**

Observe the engine temperature gauge more frequently than normal. In the event an overheating condition occurs, pull off to the side of the road and allow the engine to thoroughly cool before refilling the radiator and re-starting the engine.

# DUAL FUEL SYSTEM

## PRINCIPAL OF OPERATION OF THE DUAL FUEL SYSTEM

LP gas and gasoline engines are alike except for the delivery of fuel to the carburetor. With a gasoline powered engine, fuel is mechanically pumped to the carburetor, mixed with air and vaporized in the intake manifold. With the LP gas powered engine, fuel is delivered in liquid form, due to the internal pressure within the LP gas storage tank, to a vaporizer/regulator assembly where the liquid LP gas is vaporized and delivered to the LP gas mixer as required by the engine.

The two systems are coordinated electrically and controlled by a selector switch located on the instrument panel. When the engine is running in the gasoline mode of operation, the gasoline supply valve is opened and the LP gas supply valve is shut off automatically. The opposite is true when operating the engine in the LP gas fuel mode.

The Landi-Hartog LP gas system includes the necessary LP gas lockoff valve, control panel, and safety shut-off valve for a complete dual fuel operating system.

The function of the LP gas vaporizer/regulator is to change liquid LP gas to a vaporized gas. As the pressure is reduced, the liquid LP gas expands and vaporizes rapidly, causing a refrigerating effect. To compensate for this and to assist in the vaporization process, water from the engine cooling system is circulated through the vaporizer/regulator unit to raise the temperature of the fuel. The vaporized fuel is then delivered to the LP gas mixer mounted inside the air cleaner. Fuel is then supplied to the carburetor in the conventional manner by the engine accelerator.

### IMPORTANT

When the engine ignition is turned off during the LP gas mode of operation, a slight odor of LP gas may be detected. This is due to the evaporation of a small quantity of LP gas remaining within the carburetor and should dissipate in a matter of seconds.

### BULK FUEL TANK

Like most liquids, LP gas expands as temperature increases. For example, if a container of liquid LP gas is raised in temperature from zero to 100° F, the liquid will expand 17% or 1/6 in volume. Because of this, allowances must be made for the liquid expansion by not filling the LP gas tank completely full. Allow the tank to be

filled only to 80% capacity as indicated by the flow of liquid gas out the overflow valve or when the flow of fuel is automatically shut off at the fill adapter.

### WARNING

When liquid LP gas vaporizes rapidly, it has a refrigerating effect, and any skin contact may result in severe burns.

LP gas is odorless and cannot be detected without the addition of a strong-smelling additive (ethylmircaptan) which is placed in the product by the manufacturer. Regulations demand that the fuel be odorized so the user can discover the presence of gas before it reaches dangerous proportions. Use caution at all times. Know the distinctive odor of LP gas. If a leak is suspected, turn off the tank valve(s) immediately.

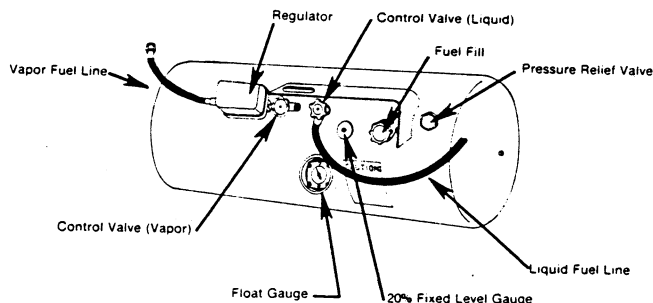

### FILLING THE BULK LP TANK

There are many LP gas refueling stations located throughout the country. These stations are listed in the telephone directory in the Yellow Pages under "Gas-Liquefied Petroleum-Bottled and Bulk".

The bulk tank is equipped with a fill adapter with both internal and external threads which allow easy filling with all LP filling equipment. The tank is full when liquid LP gas appears at the outage valve or when the flow of fuel is automatically shut off at the fill adapter.

### WARNING

Make sure all pilot lights have been extinguished before refilling LP gas tanks.

**NOTE:** Some models may incorporate a separate liquid fuel storage tank for automotive engine operation and a separate vapor fuel storage tank for motor home appliance use.

Assure that all LP gas appliances are turned off and the appliance supply valve on the LP tank is closed before servicing.

Keep in mind that both appliances and engine will be drawing fuel from the same storage tank on most models. Monitor the fuel supply to assure an adequate supply is available for all service requirements.

## WARNING

Because of the extreme flammability of LP gas and its heavier-than-air qualities, do not smoke or expose the tank to an open flame while near a refueling area. Never use an open flame to test for gas leaks.

Never allow the LP bulk tank to be filled above the 80 percent level as indicated by the flow of liquid LP out of the outage valve or when the flow of fuel is automatically shut off at the fill adapter. Make sure the vehicle is level when filling. It is possible to accidentally overfill the tank if the vehicle is unlevel, especially if the fill valve is on the uphill side. Twenty percent of the tank must remain empty to allow for gas expansion.

## OPERATION

The Landi-Hartog equipped vehicle has the capability of using both gasoline and LP gas fuel. The fuel selector and primer switches are conveniently mounted on the dash panel. The black rocker switch is the fuel selector switch, with the letter "G" denoting LP gas fuel mode and the letter "B" denoting gasoline fuel mode. The white rocker switch located below the fuel selector switch is the primer switch.

If desired, the type of operating fuel may be changed prior to the initial starting of the engine or while the vehicle is moving.

### IMPORTANT

DO NOT change from gasoline fuel to LP gas fuel while the vehicle is stopped with the engine idling.

## Dual Fuel Selector Switch

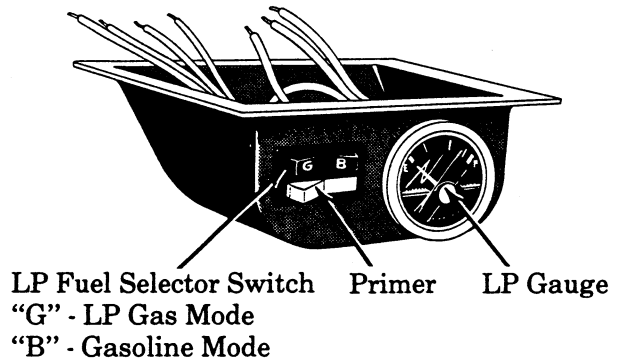

## LP Gas to Gasoline Fuel

When switching from LP gas to gasoline fuel, push the black rocker switch to the "B" position. This will open the vacuum controlled switch (electrically), deactivating the LP gas lockoff solenoid, thereby shutting off the LP gas fuel supply.

The rocker switch in the "B" position will also provide operating voltage to activate the gasoline shut-off solenoid allowing gasoline fuel to be drawn to the carburetor by the engine's fuel pump.

### IMPORTANT

You may experience a slight hesitation of the engine for a few seconds. This is due to a richer fuel mixture caused by the addition of gasoline to the remaining LP gas within the carburetor.

## Gasoline to LP Gas

When switching from gasoline to LP gas, it will be necessary to first position the black rocker switch to its neutral or center position. This will disconnect electric current to both the gasoline and LP gas shut-off valves.

Before switching to the LP gas fuel mode (position "G"), continue to run the engine until all fuel in the carburetor float bowl has been depleted. This will be evidenced by a loss of power and/or engine hesitation.

At this point, push the black rocker switch to the "G" position. This will close the vacuum switch (electrically), providing operating voltage to activate the LP gas shut-off solenoid, allowing LP gas to become available to the LP mixer.

### IMPORTANT

You may experience a slight hesitation of the engine for a few seconds. This is due to a richer fuel mixture caused by the addition of LP gas to the remaining gasoline within the carburetor float bowl.

## Shutting Engine Off

When the engine is turned off, the fuel pump is unable to draw fuel from the gasoline tank to the carburetor. Likewise, no vacuum is produced, providing a double safety feature by keeping the vacuum switch contacts electrically open prohibiting the flow of LP gas to the carburetor.

### WARNING

Vehicles equipped with an LP conversion should not be stored or serviced in a garage or enclosed area unless the following precautions are met.

- A. The fuel system is leak free and the container(s) is not filled beyond the limits specified.
- B. The container shutoff is closed on vehicles or engines under repair except when engine is operated.
- C. The vehicle is not parked near sources of heat, open flame or similar sources of ignition, or near inadequately ventilated pits.

## STARTING ON LP GAS

When starting the engine in the LP gas fuel mode, it may be necessary to prime the system. The primer switch is the white rocker switch located below the black fuel selector switch.

To prime, hold the primer (white) switch down for approximately one second while engaging the engine starter. If further priming is required to start the vehicle, make sure that the primer is held down for no more than one second at a time.

### IMPORTANT

The primer switch will activate the primer circuit only when the starter is engaged.

### IMPORTANT

The primer switch should only be pressed and held for approximately one second to eliminate the chance of engine flooding.

## STARTING - GENERAL

The engine will start best with the accelerator pedal up (in idle position), allowing the starter to turn the engine over several times before partially pressing down on the accelerator pedal. With sufficient fuel in the storage tank, internal tank pressure will move the liquid propane gas to the vaporizer/regulator assembly.

During extremely cold conditions, ample cooling

system anti-freeze should be used in the automotive radiator to prevent vaporizer freeze up. Consult your LP gas dealer for proper fuel anti-freeze requirements.

At extremely cold temperatures, -30°F. and below, the fuel pressure in the tank may drop to a point where it will not support engine operation under load. Keeping the tank full during temperature conditions such as this will be of assistance. Consult your authorized dealer or an authorized LP gas distributor for additional information.

A temperature differential of approximately 20° between the boiling point of propane (-44°F.) and the coolant temperature circulating through the vaporizer/regulator is sufficient to vaporize the fuel and support engine warm-up. The engine coolant will quickly warm up enough to meet the requirements for normal vehicle operation.

High temperature will not adversely affect the vaporization process, since the vaporizer/regulator temperature is controlled by the thermostat in the engine cooling system.

### IMPORTANT

A slightly richer mixture may be noticed as the ambient temperature increases, due to reduced air density and the relatively constant gas temperature.

## COLD WEATHER OPERATION

During extremely cold conditions, ample cooling system anti-freeze should be used in the automotive radiator to prevent vaporizer/regulator freeze up. Consult an LP gas dealer for proper fuel anti-freeze requirements.

At extremely cold temperatures, -30°F. and below, the fuel pressure in the tank may drop to a point where it will not support engine operation under load. Keeping the tank full during temperature conditions such as this will be of assistance.

A temperature differential of approximately 20° between the boiling point of propane (-44°F.) and the coolant temperature circulating through the vaporizer/regulator is sufficient to vaporize the fuel and support engine warm up. The engine coolant will quickly warm up enough to meet the requirements for normal vehicle operation.

### Warm Weather Operation

High temperature will not adversely affect the vaporization process, since the vaporizer/regulator temperature is controlled by the thermostat in the engine cooling system.

### IMPORTANT

A slightly rich fuel mixture may be noticed as the ambient temperature increases, due to reduced

air density and the relatively constant gas temperature.

## MAINTENANCE

Lower maintenance cost is one benefit of using LP gas as an engine fuel. Although the LP engine is cleaner operating, less polluting and smoother performing, there are certain preventative maintenance procedures and inspections recommended to assure proper performance.

### ENGINE BREAK-IN PERIOD

As with any internal combustion engine, a break-in period is recommended to allow proper seating of the engine piston rings. It is recommended that Winnebago and Itasca motor homes equipped with the dual fuel conversion system sustain a break-in period of minimum of 1,200 miles on gasoline fuel operation before attempting to operate the vehicle on the LP gas mode.

Upon completion of the prescribed 1,200 miles minimum break-in period, it is mandatory that the vehicle undergo complete engine tune-up and adjustment procedures as prescribed in the engine manufacturer's specifications and the LP Gas Conversion Installation Instructions. Adjustment and tune-up procedures must be performed by an authorized Winnebago Industries, Inc., LP Dual Fuel dealer to ensure optimum performance on the dual fuel system.

### IMPORTANT

For optimum LP gas fuel performance, adjustment procedures should be performed under load conditions and with the use of an engine exhaust gas analyzer.

If the engine is operated primarily on LP gas fuel, it is recommended that the engine be periodically switched to gasoline fuel to assure proper operation of the gasoline carburetor and the gasoline fuel system. Likewise, if the engine is primarily operated on gasoline fuel, periodically switch to LP gas fuel to assure proper LP gas system operation.

### LPG FUEL SYSTEM

LP gas, such as propane and butane, has vaporizing or boiling points at near normal atmospheric temperatures, thereby requiring storage under pressure to preserve the liquid state at normal temperatures. Any pressure loss within storage or transfer system will affect engine operation. It is recommended that the storage

tank and fuel lines be inspected whenever serviced and also periodically between servicing for any sign of leakage.

### WARNING

Never use an open flame to test for gas leaks.

### STORAGE

When storing your motor home for long periods of time where the engine will not be run, it is recommended that as part of your pre-storage procedure the engine be run last on gasoline fuel. This will ensure that there is gasoline in the carburetor float bowl to assist in preventing any gaskets or rubber parts from drying out during storage.

### WARNING

When the liquid LPG vaporizes rapidly, it has a refrigerating effect and any skin contact may result in severe burns.

### FUEL FILTER

The LPG fuel filter will require little servicing. Foreign matter will usually be collected in the filter of new tank installations. A new tank may contain scale or rust particles which will be caught by the filter. Some foreign elements that may be soluble in LPG, will pass through the filter but will not pass the vaporizer/regulator assembly when the liquid is vaporizing.

Should the filter become plugged sufficiently to cause a pressure drop, the fuel will vaporize and refrigerate the assembly to a point where it will visibly display frost or be very cold to the touch. In this extreme condition, the engine will present a noticeable loss of power due to insufficient fuel flow.

### IMPORTANT

It is recommended that qualified LPG service personnel be utilized to correct any LP gas problem.

### ENGINE OIL AND OIL FILTER

Since LPG provides complete combustion, there is little or no carbon and sludge build up in heads, ring grooves, cylinder walls, valves or plugs, allowing the engine to run cleaner over a longer period of time.

## **IMPORTANT**

Although the engine oil may appear cleaner for longer periods of time, clean engine oil does NOT indicate satisfactory oil condition.

Refer to the chassis manufacturer's specifications for the viscosity of engine oil and the type of oil filter recommended for your vehicle. Oil and oil filter change intervals should also follow the chassis manufacturer's recommendations listed in the chassis owner's manual.

Keep in mind that the engine may use more oil when it is new. Check oil level more often throughout the engine break-in period.

## **CHECKING ENGINE OIL**

**WARM** - The best time to check the engine oil level is when the oil is warm. Allow about 5 minutes after turning off the engine for the oil to drain back to the oil pan. Pull the dipstick out, wipe it clean and reinsert it all the way in the dipstick guide tube.

### **IMPORTANT**

When checking the engine oil level, ensure that the dipstick is inserted all the way into the dipstick guide tube in order to display an accurate oil level indication.

Pull the dipstick out and note the oil level as indicated on the dipstick. Some dipsticks are marked "Add 1 Qt." and "Operating Range". Others are marked with "Add" and "Full" lines. In all cases, keep the oil level above the add line.

**COLD** - When checking oil level of a cold engine, do not run the engine first. The cold oil will not drain back to the oil pan fast enough to obtain a true oil level indication.

## **AIR CLEANER**

LP gas in its vapor form mixes with some air as it passes through the carburetor. It is recommended that the air cleaner be inspected when the unit is serviced periodically and replaced as required.

**NOTE:** Always replace the air cleaner with the same type and size as that removed.

## **COOLING SYSTEM**

The motor home's cooling system incorporates the reserve tank coolant retrieval principal. As the cooling system temperature increases, the coolant expands and is allowed to flow into the reserve tank. When the temperature of the expanding coolant decreases, the coolant held in the reserve tank is drawn back into the radiator, providing little loss of engine coolant.

### **IMPORTANT**

Coolant should be added to the system at the reserve tank only, NOT by removing the radiator cap. Use only a mixture of permanent type antifreeze and water.

Emissions are not increased with lower operating temperatures; however, power is increased significantly as the operating temperature is decreased.

Proper cooling system maintenance will help ensure cooler engine operating temperature, reduce the pressure in the cooling system and reduce deterioration of coolant carrying hoses.

### **IMPORTANT**

When the engine ignition is turned off during the LP gas fuel operation, a slight odor of LP gas may be detected. This is due to the evaporation of a small quantity of LP gas remaining within the carburetor and should dissipate in a matter of seconds.



# ELECTRICAL SYSTEM

All Winnebago and Itasca motor homes are equipped with an electrical system consisting of two separate voltages: a 12-volt DC system and a 110-volt AC system. The 12-volt system consists of two internal power sources, while the 110-volt system is operated from an outside power source, or the optional 110-volt generator when installed in the unit. All systems operate through a single power converter control center to provide electrical power to the motor home.

## 12-VOLT DC SYSTEM

The DC voltage system consists of the automotive battery and the 12-volt motor home auxiliary battery. The automotive battery is used solely to operate the engine starter and all automotive accessories and controls found on the instrument panel. This includes the horn, speed control, all exterior lights, radio, windshield wipers, etc.

The auxiliary battery operates all 12-volt equipment located in the living area of the motor home. This includes: interior lights, range exhaust fan, furnace, water pump, water level and holding tank gauges, 110-volt generator starting, refrigerator (when operated on 12-volt mode), bath roof vent fan, ignition on water heater and the rear automotive heater. In addition, the auxiliary battery may be used to start the engine if for some reason the automotive battery is discharged; refer to "Dual Battery Switch", page 55 and "Isolator", page 55.

## 110-VOLT AC SYSTEM

The 110-volt system operates from an outside 110-volt utility service such as those at campgrounds, or from the optional 110-volt generator on units so equipped. When the power cord is connected to an outside power source, or when the generator is in operation, the power converter automatically changes a portion of the 110-volt current to 12-volt DC current. All equipment in the motor home that is normally powered by the auxiliary battery is then powered through the converter.

In addition, the following equipment is entirely dependent on the 110-volt generator or outside source: optional roof air conditioner, refrigerator (when placed on 110-volt mode), microwave oven, vacuum cleaner and other 110-volt electrical equipment used at convenience outlets.

## EXTERNAL UTILITY SUPPLY

The external utilities power cord is located in a storage compartment on the left side of the motor home.

To make an external power connection, remove the cord from the storage compartment and plug it into a suitable power receptacle. On some models, a small door allows the cord to be routed out of the compartment without the necessity of leaving the compartment door ajar.

When disconnecting the power cord, neatly replace it in the storage compartment. On motor homes equipped with a 110-volt generator, plug the power cord into the generator receptacle within the compartment.

The three wire power cord is designed to ground the electrical system through the receptacle. It is also designed to carry the amperage output of most campground outlets. If the electrical receptacle to be used is designed to mate with the three prongs on the power cord plug, the electrical connection can be expected to carry rated load. It is recommended that the power cord not be plugged in, or adapted to be plugged in, if the receptacle is not designed for the plug on your unit.

Should an overload on an appliance occur because of an excessive amperage draw, the breaker for the appliance, located on the power converter panel, will trip.

Most campgrounds are equipped with a fuse or circuit breaker on the receptacle. This protects the park's wiring, as well as the power cord on your vehicle, from electrical damage. If electrical power fails, contact the park attendants and have them check the fuse or breaker for your supply.

## WARNING

When utilizing a 110-volt AC utility supply, the polarity of the motor home must match that of the receptacle to which it is to be connected. To accomplish this, it is recommended that a commercial polarity tester be obtained. This is an inexpensive, commercially distributed device available through most retail outlets. Improper polarity matching could cause personal injury.

## POWER CONTROL CENTER

The 110-volt to 12-volt power converter is mounted within one of the cabinets or beds, depending on the model. All power (except second optional roof air and the 12-volt current to the refrigerator) to

the living area of the motor home passes through the control center before going to the individual appliances, lights, outlets, etc. Current drawn from the 12-volt battery passes through the control center unchanged, but is routed through a series of fuses to the various functions. While the unit is connected to an external power source, current draws from the 110-volt power source and is routed to the appliances or equipment through the protective circuit breakers in the control system. In addition, a portion of the 110-volt current is changed to 12-volt DC power by the convertor. While operating from 110-volt electrical power, all 12-volt equipment (with the exception of the refrigerator in 12-volt mode) is powered through the appropriate fused circuit within the convertor unit, and no power is drawn from the automotive and/or auxiliary battery.

A battery charger circuit in the convertor recharges the battery any time 110-volt external power is being used. The Charging Section will automatically "sense" the condition of RV battery. If it is below "full charge", the Charging Section will start charging the battery.

If RV battery has been drawn down quite low, will be charged at a relatively high amperage rate. If battery has not been severely drained, it will be charged at lower amperage rate. The rate of charge will decline as the battery reaches "full charge". After battery reaches "full charge", the Charging Section will drop back to "maintenance" level. It will not resume active charging until battery again falls below "full charge". If your storage battery cannot be charged as described above, it is possible the battery is defective.

A protective Thermal Breaker will "break" the 110V AC power to power converter section of Power Center if power converter becomes overheated by operation above its maximum limit for an extended period of time or obstruction of ventilation to unit.

**NOTE:** Power converter section will instantly switch 12-volt light and motors to battery.

In either case, the Thermal Breaker will reset itself after a period of time, and the lights and motors will again resume operation from power converter section - only to shortly again "break". When this occurs, take immediate steps to correct cause of overheating. A portion of RV 12-volt load - lights or motors or both - should be turned off to reduce total load. Also, inspect power converter section to make certain ventilation is not obstructed.

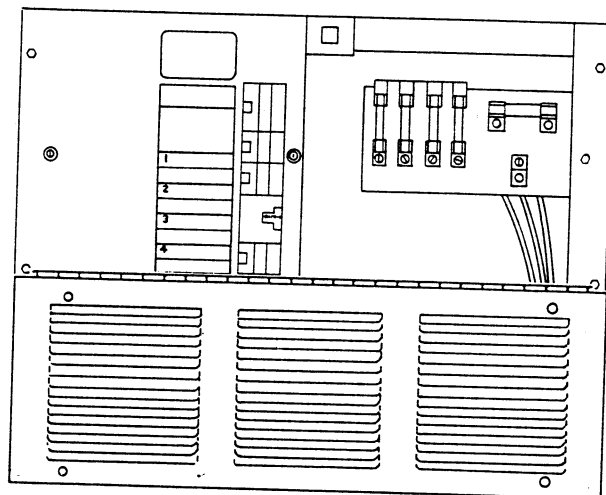

### IMPORTANT

The convertor will not change 12-volt DC current to 110-volt AC.

The breaker panel protects all 110-volt components in the living area of the motor home from either an overload on the circuit or a short in the wiring or component itself. When an overload or short develops, the breaker will open preventing any further flow of electricity, and therefore damage to the system. After shutting off the equipment (example: roof air conditioner) and allowing a brief cooling period, reset the breaker by moving the switch to "Off" then back to "On". If the breaker is continually tripped and no overload is evident, have the system checked for a short in the wiring or the appliances.

The fuse panel protects all 12-volt equipment in the living area of the motor home. When a circuit is overloaded or a short develops in any part of the system, the fuse will burn out and must be replaced before the system can again be operated. Shut off all affected lights or equipment and replace the fuse with another of equal size and amperage value.

A label located on the control panel provides the amperage of each fuse and indicates which circuit or appliance each fuse or breaker protects.

### WARNING

When utilizing the 110-volt supply cord, make sure all three prongs of the supply cord are plugged into the receptacle. If they are not or you suspect for any reason that the motor home is not grounded through the power cord, a metal rod should be securely placed in the ground and

attached to the motor home bumper by means of a metal grounding strap. Improper grounding of the motor home could result in personal injury or damage to equipment.

### WARNING

Do not store anything on or around the power converter, as it requires an unrestricted air flow to dissipate the heat that it generates.

## GROUND FAULT CIRCUIT INTERRUPTER (Standard - All Vehicles Except W/IC420RG)

The ground fault interrupter is a device connected to the 110-volt outlet in the bathroom, to the external 110-volt outlet and to certain outlets positioned elsewhere in selected models of motor homes. It is designed to prevent a fatal shock to a person in a normal state of health. Should an electrical appliance, equipped with a three prong plug which has an internal short circuit or other electrical defect, be plugged into a protected outlet, the device will automatically trip and electrical current will be discontinued to that outlet until the appliance is unplugged and the breaker reset.

Test the device monthly by depressing the test button, which is incorporated into the 110-volt breaker panel of the power control center. If the red test button breaker handle fails to trip, turn the circuit off and consult a qualified electrician. If the red test button breaker handle trips, indicating proper operation, push the handle to the fully depressed end position, then release the handle. The indicator should then show the "on" position.

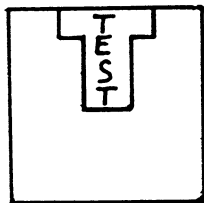

In the event the power is not available at either the bathroom or the external 110-volt outlet, check to assure that the indicator shows the "on" position.

### WARNING

The ground fault interrupter does not provide protection unless the appliance plugged into the outlet is equipped with a three prong plug which incorporates a ground wire, and the vehicle is properly grounded through the power cord or a metal ground rod connected to the bumper.

## BATTERY ACCESS

### Exterior A-Body

Depending on the motor home model, the auxiliary and automotive battery is located in a compartment accessible from the exterior of the unit. A slide-out tray within the compartment allows access for periodic inspection or maintenance.

To service or remove the batteries, remove the retainer pin and slide the tray out. On some models, the battery tray will not extend out far enough to service the back two cells. The water level of these cells may be checked by holding a small mirror at a 45° angle over the cell and shine a flashlight beam onto the battery.

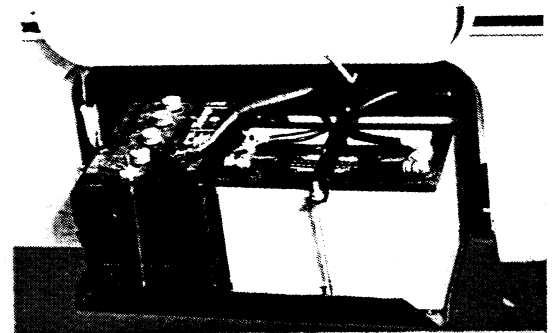

### WARNING

Reinstall the retainer pin when returning the tray to the storage position.

Sufficient cable has been provided to allow the battery tray to be pulled out for service. Care must be taken,

however, when sliding the tray back in, to avoid pinching the extra cable between the tray and the vehicle frame. Should the cable be damaged, a short could result in personal injury or damage to equipment. Replace any damaged cables at once. Always remove jewelry and wear protective clothing and eye covering when checking or handling batteries.

## Exterior C-Body

The auxiliary battery is located in a compartment accessible from the exterior of the unit or beneath the hood in the engine compartment. A slide-out tray within the compartment allows access for periodic inspection or maintenance.

To service or remove the auxiliary battery, remove the retainer pin and slide the tray out.

### WARNING

Reinstall the retainer pin when returning the tray to the storage position.

## Interior A-Body

Some models of motor homes may incorporate a battery storage compartment accessible from the interior of the unit. Generally the motor home models utilizing the interior battery compartment may be identified by the forward most entrance door installation.

The interior battery compartment is located in the floor of the unit, above the entrance door step and accommodates both the automotive and auxiliary battery.

Periodic inspection and maintenance may be performed by grasping the floor level latch and lifting the carpet covered and hinged compartment door.

## BATTERY MAINTENANCE

The battery is not a source of electricity, but only a storage reservoir. As soon as the energy required to start the engine is removed from the battery, it should be replaced by the alternator system. To ensure that the battery will always properly accept and hold a charge, some minor maintenance practices should be followed.

Make sure that the batteries always remain securely clamped in the battery tray and the

cable clamps are tight on the terminal posts and free of corrosion. Any corrosion build up on the battery can be neutralized by washing with a solution of baking soda and water and then rinsing with clear water.

### IMPORTANT

Make sure vent caps are on securely to prevent baking soda solution from contaminating the battery electrolyte.

### WARNING

Before removing any battery cables or battery, make sure all 12-volt equipment in the motor home is off and the power cord has been disconnected.

Clean and tighten battery terminals and have the specific gravity checked at least once a year. Every two months, or more often in hot weather, check the battery fluid level. Fill to approximately 3/8 inch above the plates. **DO NOT OVERFILL.** If fluid is added during freezing weather, the motor home should be driven several miles to mix water and electrolyte and prevent freezing.

### WARNING

To prevent wiring damage, it is essential when replacing the cables on the battery, or when using a "booster" battery, that the positive post and the positive cable be attached and the negative post and negative cable be attached. The posts are marked (+) plus and (-) minus. If a "fast charger" is used while battery is in the motor home, disconnect both battery cables before connecting the charger. Never attempt to charge or boost a frozen battery.

## Emergency Starting

Should it become necessary to use assist starting to start your motor home engine, the following instructions and cautions must be followed carefully. Before attempting to use booster or jumper cables for assist starting, always make sure the battery in the other vehicle is 12-volt and has a negative ground.

## WARNING

Never expose battery to open flame or electric spark. Batteries generate a gas which is flammable and explosive. To avoid personal injury or damage to your clothing, do not allow battery fluid to contact eyes, skin or fabric. Don't lean over battery when attaching clamps or allow the clamps to touch each other.

1. Wear eye protection and remove rings, metal watch bands and other metal jewelry as it could conduct an electric current.
2. Turn off the lights, heater and other electrical loads. Place transmission in park in both vehicles. Don't let the vehicles touch.
3. Remove the vent caps from the booster and discharged battery and lay a cloth over the vent wells. If either or both of the batteries are equipped with flame arrestor type filler/vent caps, the vents on that battery need not be covered with a cloth and the caps should be left in place to take advantage of the safety feature.
4. Make sure electrolyte is at proper level. If electrolyte is not visible or appears to be frozen - **DO NOT ATTEMPT ASSIST STARTING!** A battery might rupture or explode if the temperature is below the freezing point or the battery is not filled to the proper level.
5. Connect one end of positive jumper cable (red cable) to the positive terminal of the booster battery. Connect the other end to the positive terminal of the discharged battery.
6. Connect the negative cable (black cable) to the negative terminal of the booster battery and then to a location at least 12 inches from the battery on your vehicle.
7. Start the engine in the vehicle that is providing the battery boost (if it is not already running). Let it run for a few minutes, then start the engine in your vehicle.
8. Reverse the above sequence **EXACTLY** when removing the jumper cables, taking care to remove the cable from the ground location on the motor home first. Discard the cloth used to cover the filler holes of each battery and replace the filler caps.

## DUAL BATTERY SWITCH

A and C-Body Motor Homes (Not Available Diesel Equipped Vehicles)

The dual battery switch is used to connect the auxiliary battery to the automotive electrical system, allowing it to be recharged by the engine alternator while driving. The momentary position can be used to provide additional starting power from the motor home auxiliary battery, if for some reason the automotive battery is discharged.

## CAUTION

Damage to the automotive alternator can occur if the 110-volt auxiliary generator is started while both batteries are connected. Never leave the dual battery switch in the dual position when parked as it could cause both batteries to discharge.

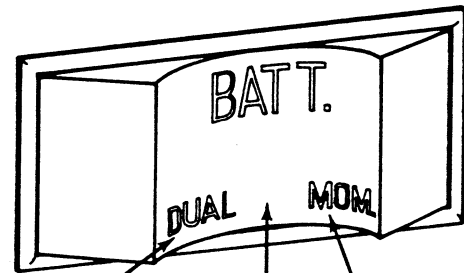

Press in to connect automotive and auxiliary batteries while driving

Middle Position: Auxiliary battery disconnected (Use when parked)

Press in for emergency power

## BATTERY ISOLATOR (Diesel Equipped Vehicles)

The battery isolator is designed to connect the auxiliary battery to the automotive electrical system, allowing it to be charged by the engine alternator while driving.

## AUXILIARY 110-VOLT GENERATOR (Optional)

The optional auxiliary 110-volt generator allows use of all 110-volt appliances when utility services are not available. The generator may be operated when the vehicle is moving or stationary and can be run continuously, if necessary.

On gasoline fueled generator sets, the generator fuel line does not draw from the bottom of the tank, thus preventing generator operation from

draining the fuel tank. There are two start/stop switches which control the generator. The remote control switch, located on the dash or overhead console panel, allows the generator engine to be started from within the motor home and while the vehicle is in motion. An indicator light incorporated within the On/Off switch will illuminate when the generator engine is operating. A second switch, located at the generator itself, can be used to start the engine at the generator location.

**WARNING**

To prevent the possibility of electrical shock, properly ground the motor home. Securely drive a metal rod into the ground and connect it to the bumper by means of a metal grounding strap.

### Exhaust Spark Arrester

Exhaust spark arresters are provided to assure auxiliary generator operation. To maintain efficient generator operation, it is recommended that the spark arrester be cleaned out every 50 to 100 operating hours.

To clean the spark arrester, remove the pipe plug in the bottom of the muffler. Run the generator for approximately 5 minutes. Replace the plug.

### 110-Volt Generator - Preparation For Use (All Units)

Before using the generator, make sure the external power cord has been plugged into the generator receptacle, located inside the cord storage compartment.

**WARNING**

Careless handling of the generator and electrical components can be fatal. Never touch electrical leads or appliances when your hands are wet, when standing in water or on wet ground. Do not attempt to repair the generator yourself. Service should be performed by a dealer or authorized service center.

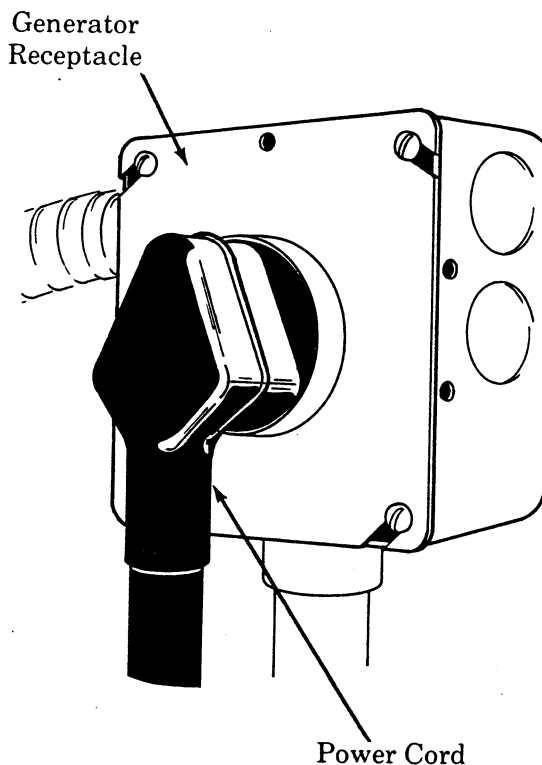

Next, start the generator engine using either the dash located start/stop switch or the one located on the generator engine itself. Refer to the starting instructions in this section for the generator unit in your vehicle.

The gasoline powered 110-volt generator may be started and operated while the motor home is in motion as long as the power cord has previously been plugged into the generator receptacle. The dual battery switch (gas engine only), located on the dash or overhead instrument console must be in the middle position prior to generator operation.

**CAUTION**

Damage to the automotive alternator can occur if the 110-volt auxiliary generator is started while both batteries are connected.

### Operation Cautions

**WARNING**

There is carbon monoxide (CO) in the exhaust of all internal combustion engines. This gas is colorless, odorless, tasteless, lighter than air and poisonous. The exhaust systems of both

your motor home engine and your generator engine have been installed with your safety in mind. However, certain precautions must be taken in their use to protect you from conditions beyond the control of the manufacturer.

1. Do not simultaneously operate the generator engine and a ventilator which could draw air into the vehicle, resulting in the entry of exhaust gases.
2. Do not open windows or ventilators on the end or side of the vehicle where exhaust of the generator is located.
3. When parked, orient the vehicle so that the wind will carry the exhaust away from the vehicle. Also, note the position of other vehicles.
4. Do not operate the generator engine when parked so that vegetation, snow, buildings, vehicles, or any other object can deflect the exhaust under or into the vehicle.

## Hourmeter

The hourmeter indicates the actual running time of the 110-volt generator set. Refer to the hourmeter often to determine when periodic maintenance is due and keep a record of all service that has been done.

## Overload Circuit Breaker

The auxiliary 110-volt generator is equipped with a circuit breaker to protect the generator and wiring from damage by an electrical overload.

All Onan generators are equipped with a circuit breaker built into the control box with a reset button located on the side. Should an overload on the generator or a short in the wiring occur, the button will pop out. Allow a brief cooling period and depress the reset button to the "In" position.

All Kohler generators are also equipped with a circuit breaker system consisting of two flip-style reset switches located on top of the voltage regulator box. Should an overload on the generator set or a short in the wiring occur, the reset switch will flip to the "Out" position. Allow a brief cooling down period and flip the switch to the "In" position.

If the overload button or switch is continuously tripped, have an authorized dealer determine the problem and correct it immediately.

## Onan 110-Volt Generator - Gas Powered - Operation

To start the generator, move start/stop switch to the "Start" position; release as soon as the

engine starts. If the engine fails to start the first time it is used, rust inhibitor oil, used at the factory, may have fouled the plugs. Remove the plug(s), clean in a suitable solvent, dry thoroughly and reinstall. Heavy exhaust smoke when the engine is first started is normal and caused by the inhibitor oil.

### CAUTION

Do not hold the switch down for an extended period if the engine fails to start. Always allow a few seconds interval before re-energizing.

### IMPORTANT

Allow the unit to warm up before connecting a heavy load.

## Stopping

When possible, allow the set to operate a few minutes without load to cool before stopping. Then move the start/stop switch to the "Stop" position and hold until the unit stops completely.

## Break-In Procedure

To ensure satisfactory service from your generator, proper oil and the recommended service schedule should be used. Use the following break-in procedure to ensure a long operating life for your unit:

1. One-half hour at 1/2 load. On 3,000 watt sets, half load can be considered one air conditioner, while on 4,000- and 6,500- watt sets, half load is equal to one air conditioner and 500 watts additional load.
2. One-half hour at 3/4 load. On 3,000 watt sets, three-fourths load can be considered one air conditioner and 500 watts additional power while on 4,000- and 6,500- watt sets, three-fourths load is equal to one air conditioner and 1,500 to 2,000 watts additional power.
3. Change crankcase oil after the first 50 hours of operation.

## Onan 110-Volt Generator Maintenance

### Engine Oil Check (4,000- and 6,500- Watt Generator Units)

Check the engine oil level daily prior to operation of the unit. The oil dipstick is part of the oil fill cap located on the outboard side of the engine. Oil level should be between low and full marks. If necessary, add oil to the crankcase to bring the level to the full mark. DO NOT overfill.

## WARNING

Do not check the oil level when the generator is operating. Hot oil may be forced out the filler neck.

After checking the oil, always reinstall the dipstick and tighten the oil fill cap securely.

### Engine Oil Check (3000 Watt Generator Unit)

Check oil level daily prior to operation of the unit. Be sure the motor home is level when checking oil. The oil level should be maintained to the bottom of the oil fill hole. If necessary, add oil until the crankcase just starts to overflow out the fill hole.

## WARNING

Do not remove oil fill cap when engine is running; oil will blow out, possibly resulting in injury.

## ONAN 110-VOLT GENERATOR

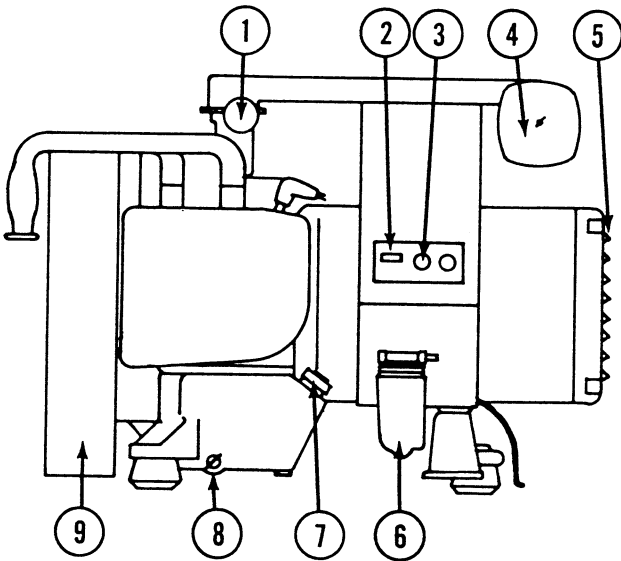

1. Electric Choke
2. Start/Stop Switch
3. Short Circuit Protection Fuses (DC)
4. Air Cleaner
5. Air Intake Ducts
6. Fuel Pump
7. Oil Fill and Dipstick (Dipstick is absent on single cylinder engine)
8. Oil Drain Valve
9. Air Discharge Scroll

NOTE: Two cylinder generator unit shown. 3000 watt unit with single cylinder engine is similar in appearance.

### OIL CHANGE

Change the engine oil according to manufacturer's recommendations which are listed in the generator owners manual provided by the generator manufacturer.

Oil capacity is:  
3000 Watt - 2 quarts  
4000 and 6500 Watt sets - 4 quarts

### AIR CLEANER ELEMENT

Under normal operating conditions, the air cleaner element should be removed and cleaned every 100 hours of operation. Tap the element on a clean flat surface to dislodge dirt particles. Do not use liquids or compressed air to clean the element, as damage to the filter material may occur. Replace the element after each 200 hours of operation or more often in dusty conditions.

### IMPORTANT

Always use the proper air filter for replacement.

### IMPORTANT

Since the generator engine is air cooled, it is important that nothing obstructs the air flow to and from the engine and generator. Make sure the cooling fins always remain clean and that the air housing is properly installed and undamaged.

### FUSE REPLACEMENT

The generator is protected from short circuits in the 12-volt wiring by two 5-amp fuses located on the generator control box. The F1 fuse protects the remote wiring to the generator "on" light and hourmeter. Failure of the hourmeter and light on the dash mounted switch to operate may indicate that the F1 fuse has blown.

F2 fuse protects the ignition circuit from shorts or overloads. If the starter operates but the engine will not start, or if the engine suddenly stops, failure of this fuse may be indicated.

Use an identical 5-amp fuse for replacement of either the F1 or F2 fuse. Should the problem occur again, have the set checked by your dealer or by an authorized Onan service center.



## Kohler 110-Volt Generator - Gas Powered Vehicles - Operation

### Pre-start checklist:

- Oil Level - At or near full mark
- Air inlets - Clean and unobstructed
- Compartment Interior - Clean
- Air Cleaner - Clean
- Exhaust System - Tailpipe clear, muffler and piping tight
- Air Baffle - Proper climate setting

### STARTING

Move either the dash mounted or engine mounted start/stop switch to the "Start" position and hold until the engine starts.

### IMPORTANT

The engine will normally start within five seconds. However, if it fails to start in ten seconds, release the switch and wait a few seconds before trying again. This will allow the automatic choke to reset in the full choke position.

Should the generator engine run out of fuel, activate the starter at ten second intervals to prime the system and set the full choke.

## KOHLER 110-VOLT GENERATOR

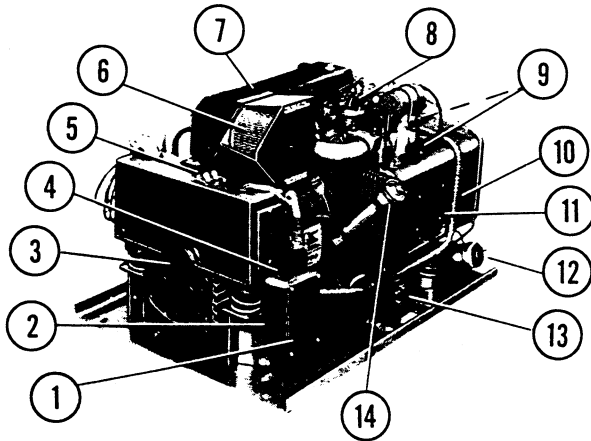

1. Start/Stop Switch
2. Controller
3. Rotor End Cap
4. Remote Control Plug
5. Circuit Protectors
6. Air Cleaner
7. Air Chute
8. Carburetor
9. Spark Plugs
10. Timing Sight Hole
11. Generator Nameplate
12. Fuel Pump
13. Battery Positive Connection
14. Oil Fill Tube and Dipstick

NOTE: 4500 watt unit shown. Other units similar in appearance.

### STOPPING

When possible, allow a brief cooling period by running the generator at low or no load for a few minutes just prior to shutdown. Then move the start/stop switch to the "Stop" position and hold until the unit stops completely.

### Break-In Procedure

To ensure satisfactory service from your generator set, use proper oil and follow the recommended service schedule. Also break-in the set by applying approximately 50% of load for 5 to 6 hours. For example, the 4500 watt set should be operated with a load of approximately 2300 watts. Breaking in a generator set under light load applications can result in excessive oil consumption.

## Kohler 110-Volt Generator Maintenance

### OIL CHECK

Check oil level in engine crankcase daily. The oil dipstick is part of the oil fill cap located on the outboard side of the engine. Oil level should be between the "L" and "F" marks on the dipstick. If additional oil is required, add oil to bring the level to the full mark. DO NOT overfill. The generator should not be operated when oil level exceeds the full mark or is below the low mark.

### WARNING

Do not check the oil level when the generator is operating. Hot oil may be forced out the filler neck.

After checking the oil level, always reinsert the dipstick and tighten the oil fill cap securely.

### OIL CHANGE

Change the engine according to manufacturer's recommendations which are listed in the generator owners manual provided by the generator manufacturer.

Oil capacity for each of the Kohler model units are:

- 3500 Watt - 1 quart
- 4500 Watt (single cylinder) - 2 quarts
- 4500 Watt (twin cylinder) - 3.8 quarts
- 5500 Watt - 4 quarts plus additional 1/2 quart when replacing filter
- 7000 Watt - 4 quarts plus additional 1/2 quart when replacing filter
- 7500 Watt - 5 quarts

## OIL FILTER CHANGE

On 5500-watt and 7000-watt units (powered by two-cylinder engines), it is necessary to change the oil filter every 100 hours of operation (every second oil change). When the oil filter is changed, it is necessary to add an additional one-half quart of oil to the crankcase.

## AIR CLEANER ELEMENT

The engine is equipped with a dry type air cleaner. Every 50 hours of operation, remove the element and clean by tapping it lightly against a flat surface to dislodge surface dust. Do not attempt to clean the element with liquid or compressed air, as this will damage the filter material. Replace the filter after each 100 hours of generator operation.

## COOLING SYSTEM

The generator has a direct air cooling system which circulates air through the generator unit and over the cooling fins on the engine. The heated air is then discharged down and out of the generator compartment.

All Kohler models are equipped with a safety trip which automatically shuts off the engine should overheating occur. When the engine has stopped for this reason, a red indicator light on the front of the "decision maker" panel will illuminate. Always determine the cause of overheating before restarting the generator. Then depress the safety reset button on the "decision maker" panel. If the set has cooled sufficiently, the light will go off and the engine can be restarted.

## FUSE REPLACEMENT

There are two fuses inside the "decision maker" controller. One is a one-amp fuse which protects the controller against damage in the event a short develops in the wiring harness to the remote start/stop switch on the vehicle's instrument panel. When this fuse blows, the set will continue running but the generator "On" light and hourmeter will not function.

The other is a 10-amp fuse which protects the generator assembly in case a malfunction occurs with the generator itself. If this fuse blows, the engine can be operated but generator output will not be available.

If these conditions are noted; shut off generator engine, remove the controller cover and check fuses. Replace fuse if found to be defective. Should the problem occur again, have the set checked by your dealer or authorized Kohler generator service center.

## Kohler 110-Volt Generator - Diesel Powered Vehicles

The Kohler LP gas powered generator operates basically the same as the gasoline powered generator (See Kohler 110-volt generator). For required maintenance schedules and information, see the generator owners manual which is provided by the generator manufacturer.

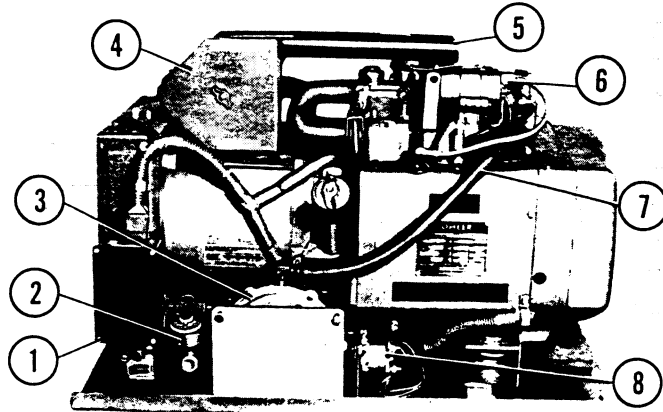

1. Controller
2. Fuel Valve
3. Regulator
4. Air Cleaner
5. Air Chute
6. Starter Solenoid
7. LP Fuel Line
8. Positive Battery Connection

## Storage Procedure (All Units)

If the generator set is to be out of service for a considerable length of time, the following steps should be taken to preserve the set before placing it in storage:

1. Run the generator set until thoroughly warm.
2. Shut off fuel supply and allow the engine to run out of fuel. Also operate the choke manually as the engine stops to help drain the carburetor.
3. Drain oil from crankcase (while hot) then flush with clean lightweight oil. Refill crankcase with regular weight oil after flushing with light oil. Replace oil filter on those engines so equipped.
4. Remove the spark plug, pour one tablespoon of oil into the hole, crank the engine several times, then reinstall the spark plug.
5. Clean exterior surfaces of generator set, then coat any unpainted metallic surfaces with light oil.
6. Plug the exhaust outlet to prevent entrance of moisture, dirt, insects, etc.

**IMPORTANT**

Regular scheduled maintenance is the key to lower operating costs and longer service life for the unit. The following schedule can be used as a guide. However, actual operating conditions under which a unit is run should be the determining

factor in establishing a maintenance schedule. When operating in dusty or dirty conditions, some of the service periods may have to be reduced. Check the condition of the crankcase oil, the filters, etc., frequently until proper service time periods can be established.

**Recommended Oil Viscosity**

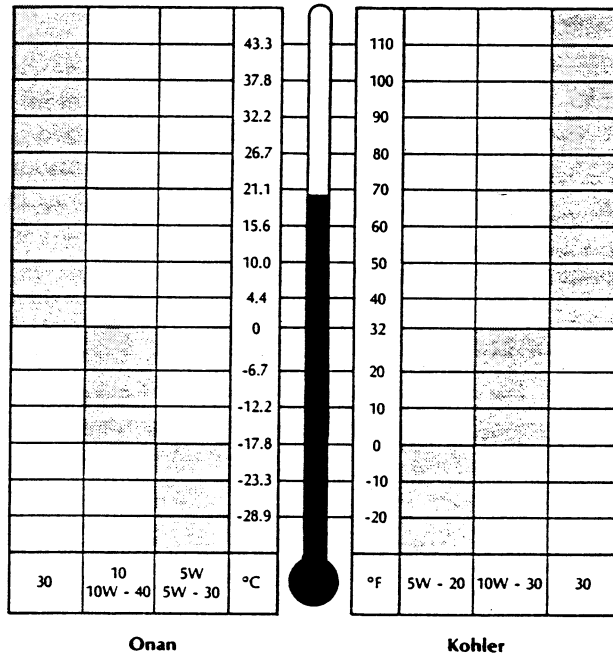

**GENERATOR SERVICE SCHEDULES**

**SERVICE SCHEDULE FOR ALL ONAN GENERATORS**

**DAILY (OR BEFORE EACH START-UP)**

- General Inspection (Check exhaust system audibly)
- Check Oil Level

**EVERY 100 HOURS**

- Clean Spark Arrester
- Check Spark Plugs (Replace annually or prior to storage)
- Check Breaker Points
- Change Crankcase Oil
- Clean Governor Linkage
- Check Air Cleaner Element

**EVERY 200 HOURS**

- Replace Air Cleaner Element
- Clean Cooling Fins
- Change Oil Filter (On those units so equipped)
- Replace Breaker Points
- Clean Crankcase Breather
- Remove Carbon Deposits From Heads

**EVERY 400 HOURS**

- Adjust Tappets
- Replace Fuel Filter
- Clean Carburetor

**AS REQUIRED**

- Check Generator Brushes (Replace if necessary)

**SERVICE SCHEDULE FOR KOHLER GENERATOR**

**DAILY (OR BEFORE EACH START UP)**

- Check Oil Level
- Keep Cooling Air Inlets and Outlets Clean
- Remove Loose Dirt from Compartment

**EVERY 25 HOURS (OR 3 MONTHS - WHICHEVER OCCURS FIRST)**

- Change Crankcase Oil (3500 Watt, 4500 Watt Single Cylinder Only)

**EVERY 50 HOURS (OR 6 MONTHS - WHICHEVER OCCURS FIRST)**

- Change Crankcase Oil (4500 Watt Twin, 5500 Watt, 7000 Watt and 7500 Watt)
- Service Air Cleaner
- Service Fuel Filter
- Check Battery

**EVERY 100 HOURS (OR 12 MONTHS - WHICHEVER OCCURS FIRST)**

- Service Spark Plug
- Check Breaker Points
- Retighten Electrical Connections
- Check Mounting Bolts and Vibro Mounts
- Replace Oil Filter (On those units so equipped)
- Replace Air Cleaner Element

**EVERY 200 HOURS OR EVERY YEAR**

- "Tune Up" At Authorized Service Center

# LP GAS SYSTEM

## LP GAS SUPPLY

LP gas (Liquefied Petroleum Gas) is a true gas, compressed into liquid form for easy transportation and storage. It is also known as bottled gas or tank gas; or simply as butane or propane which are the two types of LP gas.

The LP gas system supplies fuel for the range, water heater, furnace and the refrigerator (when placed on the LP gas mode).

Under proper conditions and handling, the system is safe, economical and provides modern living conveniences wherever you travel.

Butane and propane gas are commonly used in recreational vehicles. Butane burns hotter than propane, but will not become a usable gas vapor at temperatures lower than 32°F. Propane will not become a usable gas vapor at temperatures lower than -44°F. For this reason, propane is popular in cold climates, while butane and mixtures of butane and propane are used most widely in mild climates. LP gas is stored in the tank under very high pressure. The pressure is reduced to under one pound when it passes through the regular system. When LP is used in the vapor form, it expands many times. Your motor home uses the LP in a vapor form only.

## IMPORTANT

Most LP dealers normally handle only the type of LP gas used in their area and climate. Mixtures of butane and propane will normally be sold in the warmer southern states, while propane, which vaporizes down to -44°F, will be sold in northern states. If you are having your tank filled in one of the warmer states, but anticipate traveling into a colder area, it is advisable to request propane. Otherwise your LP gas system may fail to operate the first time the temperature drops below 32°F since the butane will not vaporize below this point.

Each gallon of liquid LP gas contains approximately 92,000 BTU's of heat energy; or, putting it another way, each gallon of LP gas produces approximately 36 cubic feet of dry gas for cooking, heating, lighting, water heating and refrigeration.

To find out how long a gallon of LP gas will last, you should determine the total BTU input on all your LP gas appliances in use. Let's say you have a heater that has a 10,000 BTU input per hour of operation. A gallon of LP gas would last 9.2 hours of continuous operation ( $92,000 \div 10,000 = 9.2$ ). To estimate how long a gallon of LP gas lasts, try to determine what your total daily

BTU input is, then divide into 92,000 to arrive at an approximate daily LP gas consumption.

## TROUBLE-FREE AND SAFE USE OF THE LP GAS SYSTEM

Use caution at all time. Know the distinctive odor of LP gas. If a leak is suspected, turn off the tank valve(s) immediately. Ask an LP gas dealer to check the system.

Have the entire LP gas system inspected for possible leaks and missing or damaged parts at the time of filling. Inspect before and after each trip, and any time trouble is suspected.

Do not tamper with the LP gas piping system, pressure regulator or appliances. Use caution when drilling holes or attaching objects to the wall. Gas lines and electrical wiring could be seriously damaged and present an extreme safety hazard.

Be sure appliance and outside vents are open and free from obstruction when using LP gas operated appliances.

Never attach a lock or device requiring a key to open the LP gas compartment door. In an emergency the tank valve must be accessible.

When not using the gas system, turn off the gas at the tank valve.

Never use a wrench to tighten the tank service valve. It is designed to be closed leak-tight by hand. If a wrench is required to stop a leak, replace the valve.

Never allow the tank to be filled above the 80 percent level indicated by the flow of liquid gas out the overflow valve.

Test the LP system with leak detector every time the gas valve at the tank is turned on.

Never operate the vehicle with LP gas appliances on or with the LP tank valve open.

Never attempt to hook up natural gas to the LP gas system.

## BULK TANK SYSTEM

The storage reservoir for the LP gas system is a horizontally mounted tank which is permanently attached to the vehicle frame. The tank is accessible only from the outside of the vehicle. The tank control valve is located near the top center of the tank, next to the regulator. Before opening the control valve, check to be sure all controls for gas appliances are in the "Off" or "Pilot Off" position. If this is not done, LP gas could accumulate inside the motorhome creating a fire or explosion hazard. The recommended procedure

for opening the control valve is to turn the knob counterclockwise until it is open all the way, then close it one quarter turn. This will enable you to tell if the valve is open or closed.

The pressure regulator is protected from the elements by a plastic cover which should be left in place at all times. Any removal of the cover and adjustments of the regulator should be done by your dealer or a qualified LP gas dealership. A system leak detector is located in the refrigerator compartment. Refer to "Leak Detector" on page 64 for operating procedures.

A float gauge located near the center of the tank, indicates the liquid level in the tank. It is recommended that the tank be refilled at an authorized LP gas dealership anytime the gauge indicates about 10 per cent of the full capacity.

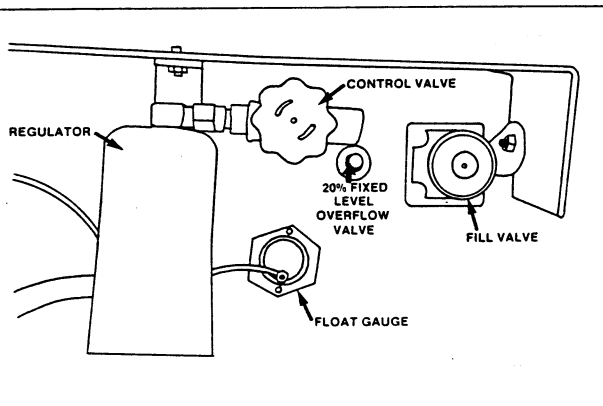

## WARNING

Do not alter or remove LP tank gauge at any time.

### Refilling Bulk LP Tank

There are many LP gas refueling stations located throughout the country. These stations are listed in the telephone directory in the Yellow Pages under "Gas-Liquefied Petroleum-Bottled and Bulk".

Since the bulk LP container is permanently mounted to the frame, the motor home must be taken to an LP dealership for filling. Do not attempt to remove the LP tank from the vehicle. The bulk tank is equipped with a fill adapter with both internal and external threads which allows easy filling with any LP filling equipment. The tank is full when liquid LP gas appears at the overflow valve.

## WARNING

Never allow the LP bulk tank to be filled above the 80 percent level. Make sure the motor home is level when filling. It is possible to accidentally overfill the tank if the vehicle is unlevel, especially if the fill valve is on the uphill side. Twenty percent of the tank area must remain empty to allow the gas to vaporize.

Make sure all pilot lights have been extinguished before refilling LP gas tanks.

Because of the extreme flammability of LP gas and its heavier-than-air qualities, do not smoke or expose the tank to an open flame while near a refueling area. Never use an open flame to test for gas leaks.

Replace all protective covers and caps on LP system after filling.

Never fill the LP tank with the engine or generator running.

## TRAVEL WITH LP GAS

All LP gas appliances must be turned off and the valve on the LP tank closed before traveling for a number of reasons:

**Safety** - Should your vehicle be involved in an accident and a gas supply line broken, LP gas would be free to escape from an open line, creating a fire hazard.

**State Regulations** - Many states are becoming increasingly regulatory about LP tanks and their use. For example, it is illegal for motor homes to pass through certain tunnels in the nation because of the LP tank aboard, even if the outlet valve is closed. We suggest you always check the local regulation of the states through which you plan to travel.

## REGULATOR FREEZE-UP

Regulator freeze-ups are caused by the presence of moisture in the fuel. This moisture will pass through the cylinder valve and into the regulator where it freezes. Fuel producers, tank and bottle manufacturers and LP gas dealers take every precaution to keep moisture out, but sometimes only a fraction of an ounce in a tank of gas can cause problems. To help avoid the possibility of freeze-up, always keep tank control valve closed

when not in use, even when tank is empty, to prevent moisture from collecting on the inside.

If moisture begins causing problems, have your LP gas dealer inject a small amount of dry methyl alcohol in your tank (approximately one ounce to 20 pounds of fuel or one pint to 100 gallons) to help guard against regulator freeze-ups.

In very cold weather when a large volume of gas is being used for heat production, it is possible to experience a loss of gas pressure. At first occurrence this problem may appear to be caused by a regulator freeze-up, but is actually caused by failure of the liquid gas to vaporize as fast as it is needed. As the temperature becomes colder, it is increasingly harder for the liquid LP gas to "boil off" into a vapor. At the same time, the demand for LP to produce heat increases to the point that the demand becomes too great. The only actual solution to this problem is to reduce the consumption of gas where possible. Adjusting the temperature on the gas/electric refrigerator may be a first step. Reducing the water temperature at the hot water heater and using less hot water will help as well.

#### Leak Detector (Marshalltown Inst.)

Your motor home is equipped with the Marshalltown Instrument LP gas leak detector.

The leak detector is mounted in the refrigerator compartment and is readily accessible and visible when required.

Read the following operating instructions prior to conducting the LP gas leak test procedure.

#### IMPORTANT

This device does not prevent leaks. It detects leakage only when activated.

#### IMPORTANT

If the detector indicates a leak, recheck to be sure all appliance gas valves have been shut off.

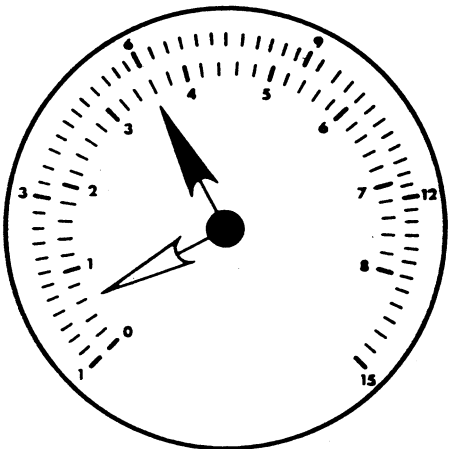

### WARNING

Do not smoke or expose the unit to open flame or extreme heat when conducting an LP gas leak test.

1. Close LP gas tank or cylinder valve(s).
2. Ventilate the vehicle. Open doors and windows.
3. Shut off LP gas appliances, including pilots.
4. Now, slowly open the LP gas tank or cylinder valve(s).
5. Observe the pressure reading on the gauge as indicated by the black pointer and match this position with the moveable red pointer.
6. Close the LP gas tank or cylinder valve(s).
7. With the LP gas tank or cylinder valve(s) in a closed position, monitor the position of the black pointer for a period of 5 minutes.
  - A. If the black pointer does not move to a lower setting on the gauge, as compared to the red pointer, your system is secure at this time.
  - B. If the black pointer does move to a lower setting on the gauges as compared to the red pointer, your system has a leak.
8. Conduct a soapy water test at all joints. Tighten, if necessary, and retest.

### WARNING

Check for leaks with each tank fill and before each overnight camping. When testing for gas line leaks with a soapy water solution, **DO NOT** use a detergent containing ammonia or chlorine. These substances may generate a chemical reaction causing corrosion to gas lines resulting in dangerous leak conditions.

If test still shows a leak, contact your Winnebago/Itasca dealer.

### WARNING

Never use an open flame to test for gas leaks.

### Air in the LP Gas Tank

Air in LP gas containers must be removed prior to the initial filling with LP gas. If the container is not properly purged, air in the container dilutes the LP gas vapor. Appliances then require constant adjustment and pilot lights won't stay lit. This condition could exist for several months until all air is depleted, leaving pure LP gas vapor. Your LP gas dealer is equipped to purge the tank with LP gas vapor prior to filling.

### WINTER USE OF LP GAS

Due to the vaporization characteristics of LP gas, it is important that the winter camper knows how to most efficiently use the LP system. The vaporization rate of LP gas decreases in a direct relationship to a decrease in temperature. As described in the "LP Gas Supply" section, butane does not vaporize below 32°F, so propane must always be used in cold climates. However, even propane vaporizes at a slower rate as it becomes colder.

The greater the amount of liquid gas in the tank (up to the 80% level) the greater the amount of LP gas vapor generated. The following is an example of the number of BTU's available from an 84 pound tank at 0°F. at three levels. As you can see the number of BTU's decreases as the tank is emptied. Nearly twice as many BTU's are available from a full tank than one that is three fourths empty. Therefore, it is to your advantage to keep the tank as full as possible (not to exceed the full level of 80% during cold weather).

BTU's Available at

Tank Level	0° F.
80%	64,400 BTU's
50%	50,400 BTU's
20%	33,000 BTU's

The following LP Gas Vaporization and Temperature Relationship chart typifies the LP gas loss with a decrease in temperature. The percentage figures are the increase or decrease in the amount of vapor that would be available at 0°F. These figures are applicable to all size LP gas tanks.

TEMPERATURE	PERCENTAGE OF BTU's AVAILABLE AT 0°F.
20°F.	200%
10°F.	150%
-5°F.	75%
-10°F.	50%
-15°F.	25%
-20°F.	12 1/2%
-44°F.	Propane will not vaporize.

### WARNING

Make sure the filling attendant uses the 80% overflow valve when filling the tank. A tank should never be filled above the 80% level to allow for vaporization and liquid expansion.

### PROCEDURES TO FOLLOW IN THE EVENT OF A LP LEAK

If at any time you smell gas within the vehicle, quickly and carefully perform the following procedures:

1. Extinguish any open flames, pilot lights and smoking materials.
2. Shut off the LP gas supply at the tank valve on gas supply connections.
3. Open doors and other ventilating openings but do not turn on any electrical fans or vents.
4. Do not touch any electrical switches.
5. Leave the area until the odor clears.
6. Have the LP gas system checked and leakage source corrected before using again.

# WATER SYSTEM

The water system in your motor home can be supplied from either of two sources: a water tank located within the motor home, or from an outside city or campground water source. The water from either source supplies the kitchen sink, shower, bathroom vanity, toilet and hot water heater.

## INTERNAL WATER SYSTEM

The internal water system consists of a light-weight polyethylene water storage tank, a water filter and a self priming water pump which automatically provides water pressure when and where it is needed. A check valve is included in the system to prevent backflow through the city water connection when the water pump is operating.

### Filling Procedure

The tank fill access is located on an exterior sidewall of the vehicle. The tank may be filled with a hose, or when city water or a hydrant is not available, a bucket and funnel may be used.

Prior to filling the tank, remove the plastic plug from the tank vent tube to allow air to escape from the tank as it is filled.

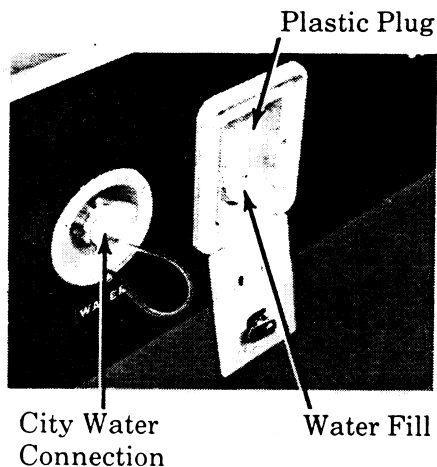

### Water Pump

Pressure from the water system is supplied by a water system demand pump which is fully automatic after initial priming. When a faucet is opened, the pump instantly begins operation to provide a constant flow from the tank. As soon as the faucet is closed, the pump automatically shuts off.

The water pump switch is located on the right side of the optional water/holding tank gauge panel. If your vehicle is not equipped with the monitor panel, the switch will be located on a

lower cabinet, the panel below a bed or on the wardrobe wall panel, depending upon model. As long as the switch is in the "On" position, the pump will automatically supply water pressure as it is needed. It is recommended that the pump switch be turned off whenever you are away from the vehicle or not using the water system. A slow leak in a faucet could drain the water system, as well as the battery.

### Initial Start-Up

1. Turn water pump switch to "Off" position. Open water fill spout and fill with hose or suitable container.
2. Open all faucets, hot and cold.
3. Turn on pump at control switch.
4. Close each faucet as it starts to deliver a steady stream of water. (Close cold water first). Leave hot water faucets on until they too deliver a steady stream of water. This will ensure that the water heater is filled with water. Make sure hot water heater drain valve is closed.
5. Check to be sure pump stops soon after all faucets have been closed.
6. Pump is now ready for automatic operation. Pump will start when a faucet is opened and stop when a faucet is closed.

### Demand Water Pump-Maintenance

Your motor home is equipped with a Shurflo direct drive demand pump.

The water pump should be inspected at three month intervals to insure proper operation and correct any apparent service conditions that may develop.

Belt drive water pumps should be checked for belt wear and proper belt tension. The motor mounting is slotted for belt tension adjustment. When properly adjusted, the belt can be moved or deflected about 1/4" half way between the pulleys. Also check to be sure the pulleys are tight on the shaft.

**Water Pump Location** - The water pump is located in one of the following locations, depending on the motor home model and floor plan:

1. Beneath the galley sink.
2. Beneath the left rear dinette seat.
3. Beneath the left slide-out couch.
4. Inside the wardrobe compartment.

Access to the pump is either through a cabinet door or beneath a dinette or couch seat cushion.



### Water Filter

A pump guard located between the storage tank and water pump contains a screen for filtering out any foreign material that may have entered the tank. This prevents damage to the pump and avoids clogging of any of the components of the water system.

The filter screen in the pump guard should be checked visually (the cover is transparent) at regular intervals to make sure it does not become clogged. When necessary, remove the cover from the guard and clean the filter thoroughly by rinsing with clean water. Then reinstall filter and cover.

## TROUBLESHOOTING DEMAND PUMP

PROBLEM	PROBABLE CAUSE	SOLUTION
Pump will not prime (It should do this automatically).	Insufficient water supply.	Check water tank level and refill if low.
	Auxiliary battery is discharged.	Recharge battery.
Pump operates but no water flows through faucet.	Insufficient water supply.	Check water tank level and refill if low.
Pump cycles on and off when faucets are closed.	Water leaks in plumbing.	Check for leaks and have them repaired immediately.
	Toilet valve not shutting off.	Check for foreign material in groove into which the blade seats. Remove any material.  Have your dealer check to be sure valve isn't defective.
Pump fails to stop when faucet are closed.	Water tank is empty.	Shut off pump and refill water tank.

## SANITIZING THE POTABLE WATER SYSTEM

To sanitize a new potable water system, systems that have not been used for a period of time, water systems that may be soured due to mineral deposits, a fill-up of bad water or the remains of water system antifreeze, the following procedure is recommended:

1. Prepare a chlorine solution using one gallon of water and 1/4 cup of household bleach (5 percent sodium hypochlorite solution). With tank empty, pour chlorine solution into tank. Use one gallon of solution for each 15 gallons of tank capacity.
2. Complete filling of tank with fresh water. Open each faucet and drain cock and operate demand pump until system is filled.
3. Allow to stand for three hours.
4. Drain and flush with potable fresh water.
5. To clean and deodorize the potable water system, add a solution of one cup baking soda dissolved in five gallons warm water for every ten gallons of tank capacity. Example: For 30 gallon tank, use 3 cups baking soda and 15 gallons warm water.
6. Agitate the solution by driving vehicle 3-4 miles or more, including stops and starts.
7. Drain the tank and flush with fresh water.
8. For a complete system treatment, run two gallons of clean soda water solution through kitchen and bathroom faucets to clean hoses and connections.

## EXTERNAL WATER SUPPLY - OPERATION

To operate from a city water supply, first turn the demand pump switch "Off". Then attach a hose to the hose connection on your vehicle and to the source of water.

### CAUTION

Because of the variance of water pressures, it is suggested you install a pressure regulator. The pressure should not exceed 60 pounds on the line, as the lines could rupture or the fixtures could leak.

A regulator should be installed at the water hook-up where the hose is connected and the hose then connected to the regulator. The pressure will be lowered before it enters the lines. When connected to an outside source of water, the water bypasses the demand pump and storage tank and supplies pressure directly to the individual faucets and toilet. A check valve built into the pump prevents water from entering the pump and filling the storage tank.

To disconnect from the external water supply, first turn off the water at the source. Open one of the faucets inside the motor home to relieve line pressure and disconnect the hose from the vehicle. Be sure to replace plug on connection after hose has been disconnected.



CITY WATER CONNECTION

# DRAINAGE SYSTEM

The drainage system may have one or two holding tanks. When two tanks are installed, one is for sewage waste from the toilet and on some models, also the lavatory sink or (on a limited number) the galley sink. The other tank is for waste water from the shower and, on most models, the lavatory and galley sink. (See drainage chart on page 72). Those with two holding tanks empty through a common fitting located on the left side of the vehicle. When the unit is equipped with one tank, the drain valve is in the same location. The drainage system is self-contained, allowing use of the toilet, sinks, or shower even in areas where sewage hook-up is not available.

## DUMPING HOLDING TANKS

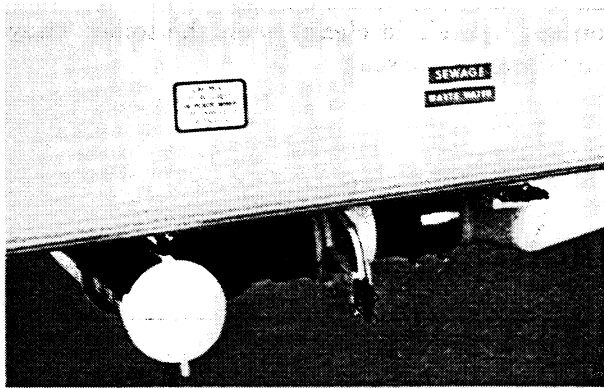

**SEWAGE DUMP VALVE**

1. Remove drain hose from rear bumper or exterior storage compartment.
2. Remove dust cap from drain and connect drain hose. Be sure it is firmly attached.
3. Place the other end of sewer hose into disposal opening.
4. Unsnap the sewage drain valve clips and open the valve with a quick pull. **OPEN ONE VALVE AT A TIME.** Move hose gently about to dislodge any waste and to ensure complete drainage.
5. Close sewage valve and open waste water valve with a quick pull. Make sure there are no sags in the hose during drainage. Close valve and snap locks over handle as soon as tank is empty.
6. After both tanks have been drained, run several gallons of water into the sewage tank through the toilet. Then open sewage dump valve and drain the tank again. Close

valve and lock in place. Securely replace dust cap.

7. It is advisable to add approximately a half gallon of water and a tablespoon of dish-washing detergent or some odor control chemical to the sewage holding tank.

### **CAUTION**

Although many detergents and bleaches have a deodorizing effect, they should not be used to clean or deodorize the toilet or holding tank. These could damage the seal in the toilet or the holding tank valve.

8. Rinse sewer hose thoroughly with water and stow.

## USE OF IN-PARK SEWER SYSTEM

When using a sewer hook-up while parked, such as in a trailer park, keep the dump valves closed; and open only when preparing to leave or when the tank becomes full. This keeps the solids in suspension, allowing them to be carried out with the rush of liquids when the dump valve is opened. If the valve is left open, the liquids will run off leaving solids in the tank. Should this accidentally happen, disconnect the hose, fill the tank about half full with water, and drive a few miles to dislodge the solids. A few starts and stops will aid in this process. Then reconnect the hose and drain in the normal manner.

## FRESH WATER TOILET (Model SL)

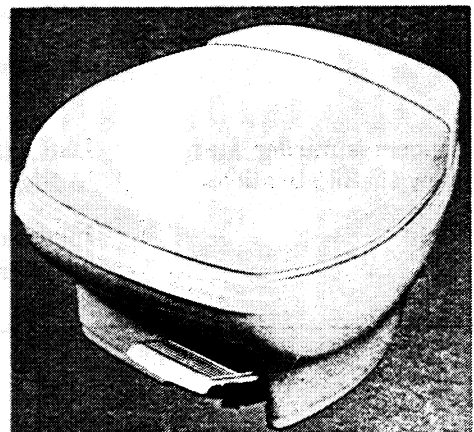

The fresh water toilet operates on the same principle as a household toilet except that it is designed to use a small amount of water. It utilizes high velocity water injection which produces a swirl effect in the bowl. Since each flush uses fresh water, chemical additives are not required. Refer to the appropriate instruction for the toilet in your vehicle.

To flush the toilet, step on the large pedal until water swirls, completely rinsing the bowl, then release the pedal. Additional water may be added to the bowl by depressing the small pedal, located on the right side of the large pedal. This pedal should be used when it is necessary to add water to the holding tank for rinsing.

**IMPORTANT**

Do not put facial tissue or regular toilet tissue in the toilet. They will not deteriorate and often cling to the sides of the holding tank. Toilet tissue made specifically for use in recreational vehicle toilets is available from a recreational vehicle

equipment dealer. Do not put automotive anti-freeze, laundry bleach, or heavy detergents in the toilet or the sewage holding tank. These products may damage the plastic or rubber parts in the system.

**TOILET MAINTENANCE**

Routine maintenance of the toilet is not required. To clean the fresh water toilet, use a high grade non-abrasive cleaner, or a commercially prepared product intended for use in RV toilets. Do not use conventional bowl cleaners, as they can damage or scratch plastic surfaces.

If after extended use, the bowl sealing blade on the foot operated toilet does not slide freely, it can be restored to its original smooth operating condition by applying a light film of silicone spray to the blade.

**IMPORTANT**

Do not use highly concentrated or high acid content household cleaners on the toilet. They may damage the seal.

**TOILET TROUBLESHOOTING**

PROBLEM	PROBABLE CAUSE	SOLUTION
Water keep running into bowl.	The blade in the bottom of the bowl is not closing completely because the groove into which the blade seats is clogged. This in turn keeps the water control valve partially open.  Defective valve.	Carefully remove the foreign material. Use care to avoid damaging the rubber seal.  Have toilet valve replaced by your dealer.
Pedal operates harder than normal or the blade sticks.	Blade does not slide smoothly in the guide.	Apply a light film of silicone spray to the blade
Poor flush	Foot pedal is not being held for sufficient flush.	Fully depress pedal.

**FRESH WATER TOILET  
(Aqua-Magic IV)**

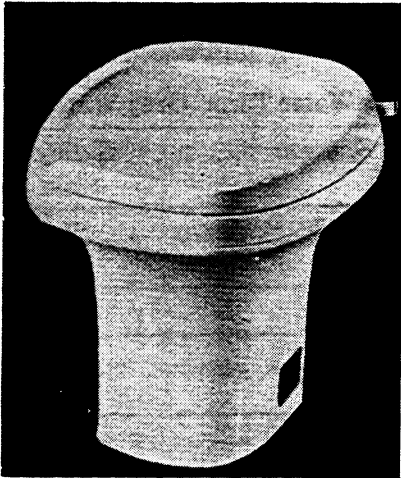

The fresh water toilet operates on the same principle as a household toilet, except that it is designed to use a small amount of water. It utilizes high velocity water injection which produces a swirl effect in the bowl. Since each flush uses fresh water, chemical additives are not required.

The toilet is equipped with two operating levers located on the right side of the toilet when facing the unit. To flush the toilet, pull the black lever forward (clockwise) until the rinse clears the bowl and release the lever slowly. Movement of the flush lever simultaneously opens the waste valve and allows waste to pass into the holding

tank and simultaneously activates water flow. The lever should be held open for several seconds to allow an adequate flush to develop. The water fill lever (white) can be operated independently of the flush lever (black) if more than the normal 2" automatic bowl refill is desired.

**IMPORTANT**

Do not put facial tissue or regular toilet tissue in the toilet. They will not deteriorate and often cling to the side of the holding tank. Toilet tissue made specifically for use in recreational vehicle toilets is available at most recreational vehicle dealers.

Do not put automotive anti-freeze, laundry bleach, vinegar solution or heavy detergents in the toilet, the water system or the sewage holding tank. These products may damage the plastic or rubber components in the system.

**TOILET MAINTENANCE**

Routine maintenance of the toilet is not required. To clean the fresh water toilet, use a high grade non-abrasive cleaner, or a commercially prepared product intended for use in RV toilets. Do not use conventional toilet bowl cleaners, as they can damage or scratch plastic surfaces.

**IMPORTANT**

Do not use highly concentrated or high acid content household cleaners or cleansers containing abrasives to clean the toilet. These products may damage the waste valve or the plastic parts of the toilet.

**TOILET TROUBLESHOOTING**

PROBLEM	PROBABLE CAUSE	SOLUTION
Water keeps running into bowl.	Sticking of the seal may be caused by foreign material on the waste valve blade or blade seal at the bottom of the bowl.	Check to see that the levers return all the way to the left. Carefully remove any foreign material from the seal or blade. Use care to avoid damaging the rubber seal.
Poor flush.	Lever is not being held for sufficient flush.	Hold the lever for 2 to 3 seconds for a good flush.
	Water supply flow rate may not be adequate.	Check to be sure water supply is adequate.  Make sure lines or water filter are not clogged obstructing flow.

## WASTE DISTRIBUTION CHART

The following chart is provided to make the owner aware of which holding tank the stool, shower and sinks are connected to for draining purposes. The chart will aid you in estimating how often you may have to drain the tanks, according to your individual camping and living habits.

S = Sewage Tank (Black Water)

W = Waste Water Tank (Grey Water)

Unit Concerned	Toilet	Lavatory Sink	Shower	Galley Sink
WC420RG	S	S	W	W
IC420RG	S	S	W	W
WC723RB	S	S	S	S
WC424RC	S	S	W	W
IC424RC	S	S	W	W
WCN22RC	S	S	W	W
ICN22RC	S	S	W	W
WCN23RG	S	S	W	W
ICN23RG	S	S	W	W
WCN26RB	S	W	W	S
ICN26RB	S	W	W	S
WCN26RH	S	W	W	S
ICN26RH	S	W	W	S
WCN27RU	S	S	W	W
ICN27RU	S	S	W	W
WCN30RT	S	S	W	W
ICN20RT	S	S	W	W
WCN30RC	S	S	W	W
WCN33RU	S	S	W	W
ICN33RU	S	S	W	W

### IMPORTANT

This chart is for information only and not an indication of when to drain the tanks. For additional information on when to drain the tanks, see Monitor/Control Panel, pages 93-96.

# EQUIPMENT AND APPLIANCES

## GAS FURNACE

Furnaces used in Winnebago and Itasca motor homes are equipped with an automatic ignition circuit which lights the main burner when the thermostat calls for heat.

The gas furnace is designed to provide safe and efficient heat throughout the interior of your motor home through the use of the LP gas and 12-volt electrical systems. The LP fuel is converted to heat at the burner and heats the metal heat exchanger. The blower then distributes this heat by way of connected heat ducts.

A fan switch, incorporated in the furnace, turns on the blower automatically when the temperature of the heat exchanger reaches a pre-set point. It is normal at the end of an operational cycle for the blower to cycle on once or twice to extract all the heat possible from the exchanger.

## SUBURBAN

### Operation - Lighting Instruction

1. To light the furnace, turn the manual valve to the OFF position and wait 5 minutes with blower running. (Set thermostat above actual temperature to operate blower).
2. After 5 minutes, set the thermostat to the OFF position.
3. Open manual valve. (Correct operating characteristics depend on this valve being positioned fully open. Never attempt to operate with valve partially closed).
4. Set thermostat on desired temperature.
5. Allow 30 seconds for main burner to light.
6. If burner does not light, set thermostat on OFF and repeat steps 1 through 5.
7. After 3 attempts with no ignition, go to shut down and determine cause.

NOTE: Do not continue to cycle furnace through thermostat in an attempt to get ignition.

### TO SHUT DOWN

1. Turn manual valve to the OFF position.
2. Set thermostat on OFF.

### BURNER ADJUSTMENT

To adjust primary air to the main burner, the small metal cover found just below and to the right of the electrode must be removed. Behind the cover is a slotted screwhead. With a screwdriver, turn screwhead counterclockwise for less primary air and clockwise for more primary air. A symptom of too much primary air will be a howling or screeching noise when the burner is

on (reduce air to correct). A symptom of too little air will be sooting on the exterior vent and a distinct yellow and floating flame (increase air to correct). A hard blue flame is the sign of correct adjustment.

NOTE: If a sooting condition cannot be corrected by the air adjustment on the burner, discontinue use of furnace until problem can be corrected by a qualified service agency.

### SEQUENCE OF NORMAL OPERATION

1. When the thermostat calls for heat, the blower motor is energized immediately.
2. As the blower motor reaches approximately 75% of the normal r.p.m. (within 3 to 5 seconds) the micro-switch, in response to the air flow, will engage, allowing current flow to the module board.
3. After a 12-18 second delay, current will pass through the board to the solenoid valve.
4. The current to the valve opens it and allows gas to the main burner. The spark at the electrode then ignites the main burner.
5. After main burner ignition (usually within 18-25 seconds), the flame detector will sense the presence of main burner flame and deenergize the lockout feature within the board. After the 12-18 second delay, if the main burner does not ignite or the flame detector does not deenergize the lockout feature within 7 seconds, the unit will go into lockout. At this time, it will be necessary to set the thermostat on OFF and repeat steps 1 through 6 of the lighting instructions.
6. After 3 attempts with no ignition, or main burner continues to go off within 30 seconds, go to shutdown and determine cause. (See Service Hints).
7. If within a period of approximately 2 minutes after the main burner is lit, the thermostat is turned back, both the blower motor and solenoid valve are deenergized. However, if the furnace continues to run longer than 2 minutes, which it normally should, a slight snap can be heard from within the casing. The snap is caused by the fan switch as it changes its position. After this occurs, if the thermostat is satisfied or turned back, the solenoid valve will close, the flame on the main burner will go out, but the blower will continue to run for a short period of time and will then shut off. The purpose of this is to remove most of the remaining gases of the heat exchanger. Be assured that this period

of blower override is a part of the unit's normal operation.

### FAN SWITCH

The purpose of the fan switch is to control the sequence of the blower operation. The fan switch is a two pole switch. When the bimetal disc of the fan switch is heated to the operating temperature, the switch closes. This completes a circuit through the motor from a direct source. The blower will continue to run as long as the chamber is hot even though the thermostat is satisfied and the main burner is off. When the chamber cools, the fan switch changes back to its original position and shuts the blower off. If the blower and burner shut off simultaneously after thermostat is satisfied, then the fan switch failed to change over. This is a symptom of a faulty switch - replace it.

### LIMIT SWITCH

The purpose of the limit control is to turn off the gas to the main burner if for any reason the furnace becomes hotter than that which is safe. Improper operation of the furnace due to the limit control does not always indicate a defective control. If the circulating air is blocked or only partially so, the limit control will function and cause the main burner to cycle. Cycling on the limit is not always undesirable - if it happens only occasionally. This is a good indication of safe operation and will most likely happen on a warm day. If cycling happens too often or for an extended period, the circulating air system should be thoroughly cleaned.

If for any reason the limit control is found to be defective, there is no recommended method of repairing it. Because of its importance for safety reasons, it should be replaced with a new one.

### WARNING

Never shunt the limit control even for only temporary operation.

### MICROSWITCH

The microswitch has two purposes:

1. It is an air prover. It operates in response to the flow of air generated by the blower. Hence, if for any reason the air from the blower is not sufficient, the switch will not operate. This may be caused by a slow motor due to low voltage, restricted return air, inadequate duct discharge area, or lint accumulation on the blower wheel.
2. The switch allows time for the blower to pull in a sufficient amount of air to support

combustion before it engages. Once it engages, the circuit is completed through the limit switch and module board to the gas valve. The valve opens, gas flows to the burner, and ignition occurs.

### BLOWER ASSEMBLY

Although one motor drives all wheels, the blowers are separate. The combustion - air blower is sealed so as to allow no passage of air between it and the circulating room-air blower. The combustion - air blower draws air from the outside atmosphere, discharges it into the combustion chamber, and forces the combustion products out the exhaust tube. The circulating room-air blower pulls return air in and forces it across the heat chamber, discharging into the area to be heated.

Sharp Blue Flame

Yellow Flame

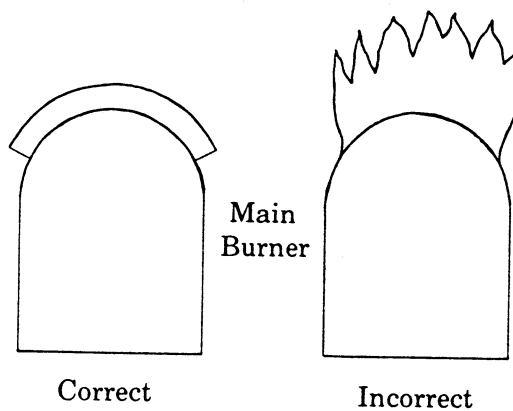

### MAINTENANCE AND CLEANING

Your furnace should be inspected before use at least annually by a professional service person.

A careful inspection of all gaskets should be made and if any gaskets show signs of leakage or deterioration, they should be replaced.

It is imperative that the control compartment, burner and circulating air passageways of the furnace be kept clean. More frequent cleaning may be required due to excessive lint from carpeting, bedding material, etc.

Periodic examination of the venting system should be maintained. It is important that the flow of combustion air entering from the rear of the furnace not be obstructed.

Periodic visual checks of the burner in operation should be made. If the primary air should need adjustment, follow the procedure outlined under Burner Adjustment.

Cleaning of the chamber and main burner will be required if the furnace has been allowed to



operate with a high yellow flame. The yellow flame is due to incomplete combustion (lack of air) and will deposit a soot formation inside the chamber and on the main burner.

The furnace is equipped with an oiled, sealed motor and requires no oiling.

**NOTE:** To service the furnace, the combustion chamber assembly must be removed from the furnace cabinet. (See instructions for removing chamber).

#### **IMPORTANT**

The furnace must be inspected and adjusted annually by a professional service person to assure proper operation.

#### **TO REMOVE CHAMBER**

1. Shut off gas at gas bottle.
2. Disconnect power supply (quick disconnect plug, right side of cabinet).
3. Disconnect gas line from manual shutoff valve.
4. Remove shutoff valve from side of furnace.
5. Remove shipping screw securing chamber shield to cabinet (lower right corner).
6. Remove the vent cap screws (outside) to free exhaust tube.
7. Pull chamber forward and out of cabinet.
8. To reinstall - reverse above procedures.

**NOTE:** Combustion chamber removal of NT-24MD and NT-30MD same as NT-24M and NT-30M.

#### **FURNACE TROUBLESHOOTING**

Should difficulties occur with the furnace, contact your dealer for assistance. However, a great number of service calls are unnecessary and could be avoided by first checking these areas of the LP gas and electrical systems:

1. Make sure there is gas to the furnace. Turn all gas valves to "On" position.
2. Make sure system switch, located inside front panel, is at "On" position.
3. Make sure electrical fuse for furnace, located on control panel, is not blown. Replace if necessary.
4. When operating on battery power, make sure auxiliary battery is fully charged.
5. Check gas supply to make certain tank is not empty or that regulator is not frozen.
6. If pilot continuously goes out, make sure observation cap with gasket is secure.
7. Check pilot flame - if not easily seen and a blue color, have a serviceman adjust to proper size and color.

8. Make sure registers are fully open and not blocked, pinched or bent closed.

#### **RANGE AND OVEN**

The range and oven in your motor home are operated on LP gas and will provide nearly all of the functions that the range in your home does. One of the features of gas burners is that heat is available as soon as a burner is lit; as opposed to an element heating up. The range has a "Pilot Off" position on the oven control which allows the oven pilot to be turned off when traveling or refilling the LP tank.

#### **WARNING**

Do not use range or oven for comfort heating of the coach.

#### **Use of Top Burners**

1. Light match.
2. Turn control knob left (counterclockwise to the full "On" position).
3. Apply lighted match immediately to the burner.
4. Adjust the flame height by turning the knob toward the "Off" position.

#### **WARNING**

Do not turn burner control knob to "On" and allow gas to escape before lighting match.

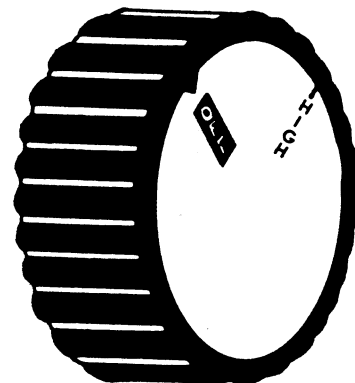

**BURNER CONTROL**

## Use of the Oven

The oven is controlled by a low temperature thermostat which has no by-pass setting and will cycle off and on at all temperature settings except broil ("B").

### Lighting Instruction:

1. Make sure oven thermostat dial is set at "Pilot Off" position.
2. Make sure LP gas tank valve is open.
3. Depress and turn oven thermostat dial to the "Off" position.
4. Open door and light oven pilot with a match. A small flame will be noted at the top of the pilot burner.

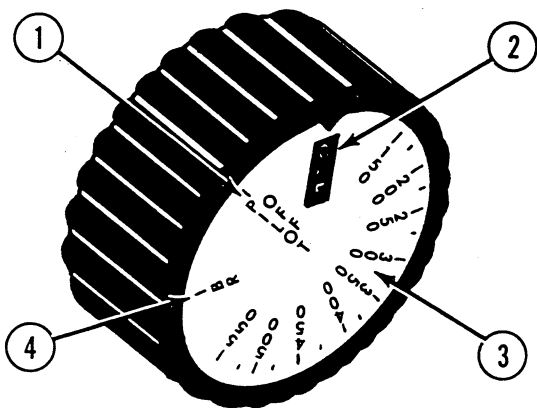

### OVEN CONTROL

1. "Pilot Off" Position
2. "Off"
3. Temperature Range
4. "Broil" Position

## Operating the Thermostat

Depress and turn the thermostat dial left (counter-clockwise) to the desired temperature setting. There is a delay of about 45 seconds before the main burner ignites; this is also normal and no gas is escaping at this time. It is also normal for the oven burner flame to cycle off and on at all temperature settings except broil. This is to maintain a constant temperature in the oven.

## Using Low Temperature

The oven in your motor home is capable of maintaining temperatures in the low range of 140 to 225 degrees. This feature allows the appliance to be used as a warming oven.

## Shut Down Instructions

Turn the thermostat dial to the "Off" position. In this position, the oven standby pilot flame will remain lit.

When the motor home is not in use, or while traveling, turn the thermostat dial to the "Pilot Off" position and turn off the gas supply at the LP tank.

## Care and Cleaning of the Range and Oven

To keep the range looking bright and new, wipe all surfaces after use with a warm detergent solution and a soft cloth. Porcelain enamel is glass which has been fused to metal. Properly maintained it will provide years of dependable service. Steel wool pads, wire scours and gritty cleansers will scratch or wear the surface, and therefore should not be used. Use a gentle cleaning powder or chemical grease remover. Some foods contain acid which will dull the porcelain finish. Among these are vinegar, lemon juice, tomatoes and milk. Wipe up all spills immediately.

### IMPORTANT

Make sure glass surfaces are cool before wiping with a detergent and water solution.

The brushed chrome range top can best be cleaned with a damp cloth, and dry thoroughly. Stubborn stains may be removed with chrome polish.

### IMPORTANT

Brush chrome range tops may show signs of rust on underneath side due to certain atmospheric conditions and oxidation from the top burners. This is especially true in areas of high humidity and salt air areas. Keep the underneath area as dry as possible under these conditions or coat with a high heat tested rustolium or silicone paint if necessary.

## Range Troubleshooting

With proper care, your range should provide several years of trouble-free service. Should difficulties occur, contact your dealer for assistance. However, before seeking service, it may save time and money to check to be certain the problem is not caused by misuse:

1. Air Circulation - Gas ovens must have free circulation of air to operate properly. Heated air comes in through openings in the oven bottom for even - temperature cooking. Anything which blocks or changes this air flow can cause poor results. A pan touching the

side of the oven can block air flow, as well as conduct heat from the side which it is touching. This can result in uneven baking on one side. The use of pans that are too large or sheets of aluminum foil to catch drippings or spillover will have the same effect and block air flow, as well as reflect heat from the bottom.

### IMPORTANT

There should be at least one or two inches between the edge of a utensil and any oven surface.

- Oven Cleaners - Oven cleaners (particularly the spray type) can coat the thermostat sensing device and cause it to malfunction. If oven cleaners must be used, protect the sensing device from the spray or wipe it off immediately.

### CAUTION

If a commercial oven cleaner is used, protect aluminum gas tubing, thermostat sensing bulb and electrical components from the cleaner. (Masking tape can be used.) Thoroughly rinse oven with a solution of one tablespoon of vinegar to 1 cup of water.

## NON-POWERED RANGE HOOD AND VENT

The non-powered range hood has a vent cover located beneath the hood which must be opened when the range or oven is in use to expel cooking odors and gas fumes. The cover is spring loaded to hold open when unlatched and will seal out outside air when closed. A light with an on/off switch is also located on the underside of the hood.

## LITTON MICROWAVE OVEN (Optional)

The microwave oven is equipped with many features that make cooking fast, simple and efficient. In addition to the timer, which allows selection of the recommended cooking time, it also provides a variable power control, which regulates the level of microwave power to be used. It also provides a temperature control, which uses a probe to measure the internal temperature of the food being cooked.

PROBE		MEMORY	
		1	2
HOLD		POWER LEVEL	CLOCK
TIME	TEMP	POWER LEVEL	
LOW		1	
WARM		2	
WARMER		3	
MED LOW		4	
DEFROST		5	
BRAISE		6	
MEDIUM		7	
BAKE		8	
MED HIGH		9	
TIMER		0	
CLOCK	CHANGE-CANCEL	START	

### OPERATION CAUTIONS

Do not attempt to operate a microwave oven with the door open since open-door operation can result in harmful exposure to microwave energy. It is important not to defeat or tamper with the safety interlocks.

Do not place any object between the oven front face and the door or allow soil or cleaner residue to accumulate on sealing surfaces.

Do not operate the oven if it is damaged. It is particularly important that the oven door close properly and that there is no damage to the door (bent), hinges and latches (broken or loosened) and door seals and sealing surfaces.

Do not allow anyone except properly qualified service personnel to adjust or repair the microwave oven.

Do not attempt to dry clothing or other material in the microwave oven.

Refer to the "Cooking Utensils" section of your Litton® "Cooking Guide" to answer any questions concerning cooking with metal containers.

## OPERATING INSTRUCTIONS

1. Open the door; the interior light will come on automatically when the door is opened.
2. Place food in the oven and close the door.
3. Push the "Time" pad. The colon will appear in the display and the "Memory 1" indicator light will come on.
4. Set the desired cooking time by pushing the appropriate number pads. The time you have selected will appear in the display. To set one minute, push 1,0,0. To set one minute thirty seconds, push 1,3,0.

### IMPORTANT

Consult your Litton® "Cooking Guide" for recommendations of proper cooking times for various food products.

5. Push the "Power Level" pad. The power level indicator light will come on and "HI" will appear in the display. This is to remind you that the oven will always operate on HIGH unless you select a different variable power. If you wish to cook on "HIGH", push the "Start" pad.
6. Select the variable power setting. Push the number pad next to the variable power word setting. If, for example, the recipe calls for cooking the medium setting, push number "7". The display window will read "70" indicating that the oven is operating at 70% of full power.
7. Push the "Start" pad. The time you select will appear in the display window. The oven blower will come on and the oven will begin cooking. Time count-down will begin. When the time is up, a tone will sound three times, and the oven will stop cooking automatically. If your oven has the time of day clock feature which has been programmed, the time of day will appear in the display. Otherwise the colon will remain on about 5 minutes.

### CARE OF THE MICROWAVE OVEN

A minimum amount of maintenance is required to keep your Litton® microwave oven clean and trouble-free. The stirrer cover and the oven itself should be cleaned after each use with a damp cloth to keep it free from grease and soil build-up. Stubborn soils can be removed with a plastic scrub pad. Use liquid window cleaner or a mild detergent, water and a soft clean cloth to clean the oven face and interior surfaces. Odors can be eliminated from the inside of the oven by boiling a solution of one cup of water and several tablespoons of lemon juice in the oven for 5-7 minutes.

This also helps loosen any dried food particles in the oven. Be very careful not to scratch the door and interior surface. Wipe out excess moisture after every use.

Do not use abrasive cleaners, cleaning pads or steel wool. Do not remove stirrer cover or insert knife around stirrer cover when cleaning as it may damage the cover or affect the performance of your oven.

To clean the temperature probe, remove it from the oven receptacle. Wipe food or liquid from the probe with a damp cloth. Dry completely after use and washing. Never attempt to clean the temperature probe in the dishwasher.

Refer to the Litton® "Use and Care Manual" and the Litton® "Cooking Guide" for further information on the operation of the microwave oven.

### REFRIGERATOR (Norcold)

The refrigerator in your motor home is an absorption type which uses an ammonia-water solution for cooling. Basically, ammonia vapor is distilled from the solution by heat, produced from either LP gas or electricity and then carried to the finned condenser where it liquifies. The liquid flows to an evaporator where it creates cold temperatures by evaporating into a circulation and cause the cooling process to stop.

Before operating the refrigerator when the motor home is stationary, place a small level on the freezer plate and make certain the unit is level. Normal refrigeration installation is such that the freezer plate is parallel to the motor home floor. If the refrigerator is unlevel, then leveling the motor home in the proper direction will automatically level the refrigerator, and cooling performance will be satisfactory.

### CAUTION

To obtain proper performance from the refrigerator and prevent damage to the cooling unit, make certain the motor home is level side to side and front to rear when parked. When the motor home is in motion, the continuous movement will not affect the refrigerator since the rolling and pitching action will prevent pockets of liquid from forming. If the motor home is parked in an out of level position for more than one hour, the refrigerator must be turned off.

Keep in mind that as convenient as RV refrigerators are, they are not as efficient as the larger unit in your home. The absorption refrigerator relies on a free circulation of air for cooling. When placing items in the refrigerator, be careful not to fill the compartment too full or place too many items around the evaporator fins, thereby blocking necessary air circulation. Also, a longer period of time is required to cool the storage compartment on an absorption refrigerator as compared to a freon cooled model in your home. For this reason, it is recommended that the refrigerator be started up 12 hours before any items are placed in the cabinet, whenever possible. Do not place warm items in the refrigerator and expect them to cool within a few hours. Transfer foods from your refrigerator at home, or buy items, such as soft drinks that have been cooled at the store, for maximum efficiency.

**IMPORTANT**

Any attempt to measure the temperature of the cooling compartment should be made by placing a thermometer in a food substance or liquid. Measuring the air temperature may result in a false reading.

**CONTROLS - MANUAL IGNITION**

All refrigerator controls are mounted on the front of the cabinet and are accessible by opening the food storage compartment door. Controls consist of a selector switch and a single thermostat that regulates the desired cooling temperature on gas and electric operation. The electric and gas controls are so designed that single operation of the refrigerator on either of the heat sources is assured. It is not possible to operate the unit on both LP gas and electricity simultaneously.

**GAS OPERATION - LIGHTING INSTRUCTION**

1. Make sure refrigerator is level.

2. Turn on gas supply at LP bottle.
3. Turn thermostat to (A) maximum cold or full clockwise position.
4. Turn the operational selector knob (B) so the knob indicator is pointing to the word "gas".
5. Depress and hold in the safety valve button (C) while simultaneously pushing in on the spark ignitor (D). While leaving the safety valve button depressed, continue to push the ignitor until a flame is seen through the flame viewer. Hold the safety valve for approximately 15 to 30 seconds after the flame is visible. Upon release, the flame should remain on if the unit is on the gas operated mode.
6. If after a few hours the refrigerator compartment is found to be too cold, turn the thermostat to a warmer setting (lower number).

**ELECTRIC OPERATION - STARTING INSTRUCTIONS**

1. Make sure refrigerator is level.
2. Turn thermostat to maximum cold or full clockwise.
3. Turn the operational selector knob so the knob indicator is pointing to the word "electric".
4. If after a few hours the refrigerator compartment is found to be too cold, turn the thermostat to a warmer setting (lower number).

**CHANGING OPERATION MODE**

To change from LP gas operation to 110 volt electric operation, simply turn the selector to electric and the change will have been made. Since the thermostat controls both the gas and electric operation, the necessity of resetting the temperature when a power source is changed is eliminated. To change from electric to gas operation, turn the selector to the word gas and follow the lighting instructions for gas operation.

**MANUAL IGNITION**

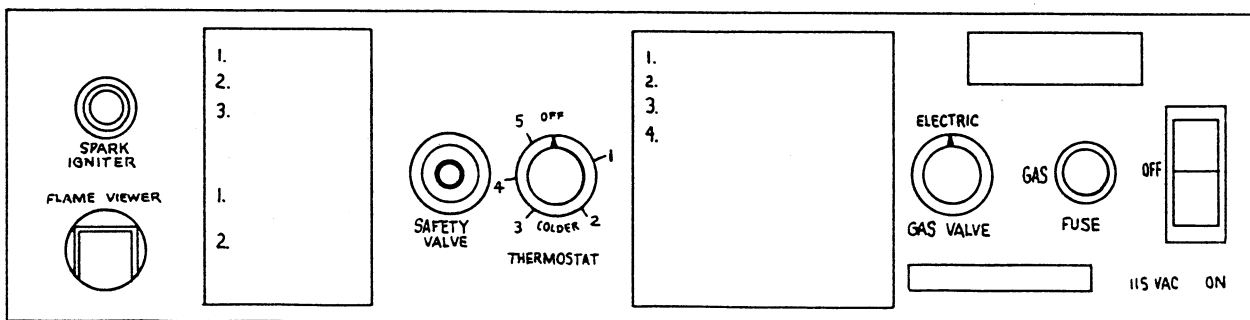

## REFRIGERATOR SHUT DOWN

To shut off the refrigerator for extended periods, follow the procedure.

1. Turn the thermostat to the "Off" position (full counterclockwise). This will interrupt the AC power. If the unit has been operating on LP gas, turn the operational knob to "electric" to ensure the gas supply is shut off at the control manifold.
2. Disconnect the AC power supply and turn

off the LP gas supply at the bottle.

3. Remove, empty and thoroughly dry the ice cube trays.
4. Remove all foodstuffs from the freezer and food compartments.
5. When the refrigerator has defrosted, clean the entire interior of the unit using mild soda solution. After cleaning, the door should be left slightly ajar.

## REFRIGERATOR TROUBLESHOOTING MANUAL IGNITION

PROBLEM	PROBABLE CAUSE	SOLUTION
Food items are not cooled sufficiently in spite of thermostat being set at "coldest".	Cabinet area has been filled too full and air circulation has been blocked.	Remove unnecessary items and rearrange to provide circulation of air around the evaporator fins.
	Warm items have been placed in the cabinet.	Allow more time for cooling warm items. Utilize items that were previously cooled in the home refrigerator or a store cooler.
	Cooling compartment was not allowed to cool sufficiently before filling.	In the future, start the refrigerator and allow it to cool a few hours before filling.
	Refrigerator unlevel.	Level the motor home, if it cannot be leveled, shut the refrigerator off.
	Insufficient LP gas supply.	Check LP tank and refill if necessary or switch to 110-volt electric operation.
	Thermostat failed.	Have your dealer replace thermostat.

## REFRIGERATOR TROUBLESHOOTING MANUAL IGNITION

PROBLEM	PROBABLE CAUSE	SOLUTION
No burner flame or flame does not stay on.	Safety valve thermocouple out of position or defective.	Reposition thermocouple. Replace thermostat, safety valve thermocouple.
	Improper gas pressure.	Check main line gas pressure, regulator pressure at the control assembly.
	Orifice dirty or clogged.	Remove, clean and/or replace orifice.
	Defective safety valve.	Replace safety valve.
Burner flame hard, noisy or lifting.	Baffle missing in flue.	Install baffle.
	Defective or improper orifice.	Clean or replace orifice.
	Gas pressure too high.	Check and set pressure.
Burner is hard to light.	Electrode bent.	If there is no spark directly above burner, electrode should be adjusted and lead wire checked for electrical leaks.
	Low gas pressure.	Check gas pressure at pressure tap tee as well as main line gas pressure. See section on gas pressure settings. If there is no reading, be sure the refrigerator gas control valve is turned on. Also be sure the gas bottles are turned on and not empty.

## REFRIGERATOR TROUBLESHOOTING MANUAL IGNITION

PROBLEM	PROBABLE CAUSE	SOLUTION
During electric operation refrigerator does not cool satisfactorily.	Thermostat at wrong setting.	Turn thermostat dial setting to high.
	Refrigerator not level.	Level both ways in freezer compartment.
	Air leakage into cabinet.	Check fit of door gasket.
	Freezer heavily coated with frost.	Defrost refrigerator.
	Low voltage.	Supply voltage at refrigerator should be to these specifications: A.C. supply voltage should be 132 volts maximum and 108 volts minimum. D.C. supply voltage should be 15.4 volts maximum 10 volts minimum.
Refrigerator too cold.	Defective heating element.	Check heater wattage. See section on heater within specifications. If incoming supply voltage is within specifications and the wattage of the heating is incorrect, heater needs to be replaced.
	Thermostat set too cold.	Turn to a warmer setting.
	Room temperature abnormally cold.	Turn thermostat dial to a warmer position during cooler hours and return it to a colder setting during the day.
	Capillary sensing tube improperly connected to lower evaporator fin.	Check that the end of the sensing tube is making good contact with the fins.
Burner flame soft or yellow	Defective gas control.	Check that the flame changes from high to low flame as the thermostat is turned from off to maximum. If not, thermostat needs to be replaced.
	Burner air passage clogged.	Clean air passage.
	Burner flue clogged.	Clean flue.
	Defective or improper orifice.	Clean or replace orifice.



## ELECTRONIC IGNITION

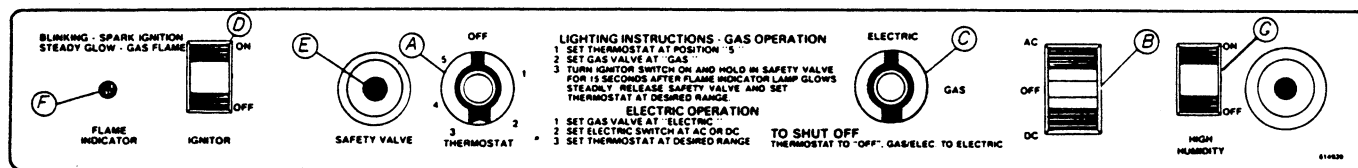

### CONTROLS - ELECTRONIC IGNITION

All refrigerator controls are mounted on the front of the cabinet and are accessible by opening the food storage compartment door. Controls consist of a selector switch, an AC-DC switch, an ignitor switch, a high humidity switch and a single thermostat that regulates the desired cooling temperature on gas and electric operation. The electric and gas controls are so designed that single operation of the refrigerator on either of the heat sources is assured. It is impossible to operate the unit on both LP gas and electricity simultaneously.

### GAS OPERATION - LIGHTING INSTRUCTIONS

1. Turn the thermostat (A) to the maximum cold position (full clockwise).
2. Place electrical selector switch (B) at "Off" position (EG3 models only).
3. Turn the operational selector knob (C) so that the knob indicator is pointing to the word "Gas".
4. Turn on the igniter switch (D). A flashing indicator lamp (F) shows that an ignition spark is present at the burner.
5. Hold the safety valve button (E) in until the indicator lamp glows steady. Continue to hold the safety valve in for fifteen seconds and then release. The indicator lamp should continue to glow steady. If the lamp starts flashing, repeat this step. (On initial start-up ignition may require a longer safety valve hold in period due to presence of air in the gas line. The air must be replaced by gas before burner ignition is possible).
6. Turn the thermostat to the desired temperature setting.

### GAS OPERATION - SHUT OFF INSTRUCTIONS

1. Turn the thermostat knob (A) to "Off". This will interrupt all electrical power to the heater.
2. Turn the operational knob (C) to "electric". This shuts the gas supply off at the control manifold.
3. Turn ignitor switch (D) to "Off".

### ELECTRIC OPERATION - STARTING INSTRUCTIONS

1. Set thermostat (A) to the maximum cold position (fully clockwise).
2. Turn the operational selector knob (C) so that the knob indicator is pointing directly to the word "electric".
3. Position the selector switch (B) to the desired power source, either "AC" or "DC".

NOTE: DC operation is designed to minimize battery drain and only intended to sustain cooling (after refrigerating temperatures have been attained on AC operation).

4. Set thermostat knob to desired temperature setting.

### ELECTRIC OPERATION - SHUT OFF INSTRUCTIONS

Turn the thermostat knob (A) to "Off". This will interrupt all electric power to the heater and stop the refrigerator operation.

### HIGH HUMIDITY SWITCH

This switch prevents condensation (moisture) from forming on the control panel during periods of high humidity. The switch should be on only when moisture is noticed on the control panel and off during other times.

NOTE: Turn switch off when the refrigerator is not in use to prevent "trickle" drain of battery.

## REFRIGERATOR TROUBLESHOOTING ELECTRONIC IGNITION

PROBLEM	PROBABLE CAUSE	SOLUTION
Electrode shows no visible spark.	Switch in "Off" position.	Turn switch to "On" position.
	2 amp fuse blown.	Replace fuse.
	Wire disconnected on electrode or at gas module.	Secure wire in place.
	Ceramic electrode cracked.	Replace burner assembly.
	No voltage to terminal on back or refrigerator.	Check battery voltage to refrigerator terminal. Specifications are 15.4 volts maximum - 10. volts minimum.
	Electrode out of position.	Reposition electrode to 1/8" (inch) above burner cap and centered in the first slot on the burner cap.
Electrode is sparking but burner will not ignite.	Gas module defective.	Replace gas module.
	Electrode not positioned correctly.	Electrode should be approximately 1/8" (inch) above burner cap, and centered over first slot in burner cap.
	No gas present at burner.	Safety valve must be pushed in when trying to light burner. Gas control valve at refrigerator has to be in the gas position. Main supply tank valve has to be turned on with gas in it.

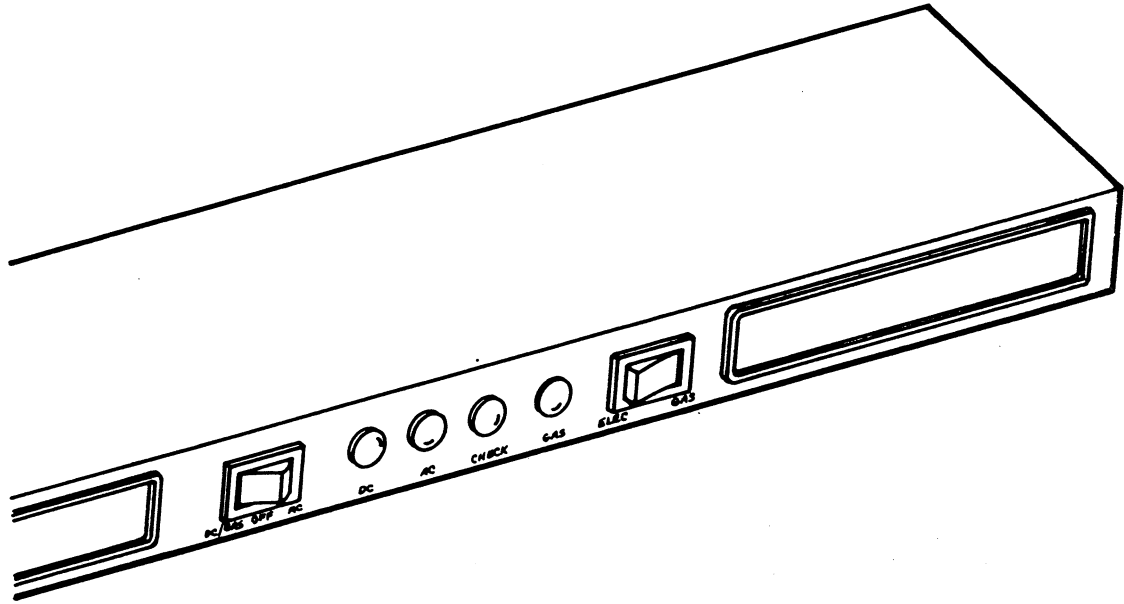

## CONTROLS-ELECTRONIC IGNITION WITH ELECTRONIC MODE SELECTOR

All refrigerator controls are mounted on the front of the cabinet and are easily accessible by opening the food storage compartment door, (thermostat location) or by reaching above the freezer door (mode selector). Controls consist of a mode selector panel and a thermostat that regulates the desired cooling temperature on gas and electric operation. The electric and gas controls are so designed that single operation of the refrigerator on either of the heat sources is assured. It is impossible to operate the refrigerator on both LP gas and electricity simultaneously.

### MODE SELECTOR

This refrigerator is equipped with a mode selector panel, which eliminates the pushing of ignitors or the holding in of gas valve switches. For example, if gas operation is desired, the user depresses the gas mode switch, causing rapid sparking at the burner. If LP gas is present and safety controls are satisfied, the burner ignites and cycles according to the setting on the thermostat. The refrigerator will continue to operate in the gas mode until the user selects either the electric mode or turns the refrigerator off. Likewise, depressing the switch for an electric mode causes operation in that mode provided the proper electric voltage is present.

A set of indicator lights confirms the operating mode for the user. Blue indicates the gas mode; green indicates 110-volt AC mode; and amber indicates 12-volt DC mode. Also, a red check light indicates loss of flame.

## ELECTRONIC IGNITION - GAS OPERATION

This Norcold refrigerator is equipped with electronic ignition offering the following features:

- (a) Automatic ignition and gas start-up using the Mode Selector (no ignitors to push, buttons to hold in.)
- (b) Automatic re-ignition in case of flame blow-out.
- (c) Positive flame monitoring. The control panel indicates the presence of a flame so long as the blue (gas mode) light is on and the red (check) light is off. If the flame is lost or fails to ignite, the red light comes on (in addition to the blue). This feature eliminates hard-to-see flame viewers.

The electronic ignition module, located at the rear of the refrigerator is powered by 12 volts DC. This system is quite similar to the Spark Ignition systems so popular in residential energy saving furnaces. Because the ignition is self-starting, there is no pilot flame to waste energy. When the thermostat is off, the flame is extinguished; when the thermostat is on, the flame is on.

As noted, a 12 volt DC source is required for operation on gas. It is this 12 volt system which provides the features of automatic ignition, protection against flame blowout, etc. The user should be aware of this 12 volt requirement and ensure the supply is maintained. The current drain is quite low (less than 500 milli-amps); nevertheless, the refrigerator should not be operated long periods of time from a battery only, without occasional recharge (through alternator or converter).

## THERMOSTAT

The thermostat controls both the gas and electric operation thereby eliminating the necessity of resetting each time a different energy source is employed.

At the extreme counter-clockwise setting of the dial, the refrigerator is off. This setting is for defrosting the unit. The dial is turned clockwise for colder temperatures. The higher the number on the dial, the colder the setting.

## LIGHTING INSTRUCTIONS – GAS MODE

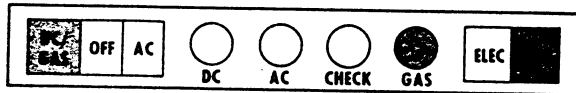

1. 12 volt DC supply must be on in order to energize the direct spark ignition system.
2. Turn thermostat to mid range position.
3. Depress GAS-ELEC switch to GAS position, depress DC/GAS-OFF-AC switch to DC position. Sparking will start at burner and gas valve will open. Blue light indicates the refrigerator is in the gas mode. (If blue light does not come on, check for loss of 12 volt supply.)
4. After 10 seconds, the burner should be ignited and operating normally.
5. On the initial refrigerator start-up, it may take longer than 10 seconds to allow air to be purged from the gas line. If the gas does not ignite within 10 seconds, valve will automatically shut off indicated by the red check light.
6. To restart when the check light is on, depress DC/GAS-OFF-AC switch to OFF, and wait 10 seconds - then depress switch again to DC position.

**DO NOT CONTINUE TO RESET SWITCH IF THE CHECK LIGHT CONTINUES TO COME ON AFTER SEVERAL TRIES.**

## STARTING UP INSTRUCTIONS – AC

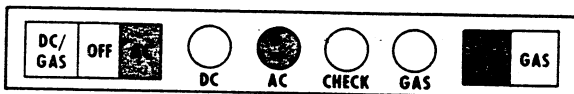

1. 110 volt supply must be on at refrigerator to operate on AC electric.
2. Turn thermostat to mid range position.
3. Depress GAS-ELEC switch to ELEC position; depress DC/GAS-OFF-AC switch to AC position. Green light will indicate the refrig-

erator is operating properly in the AC mode. (Green light confirms presence of 110 volts and remains on when the thermostat is satisfied.)

**NOTE:** If green light glows regardless of switch settings, the hot and neutral wires may be reversed at the 110-volt receptacle.

## START UP INSTRUCTIONS – DC

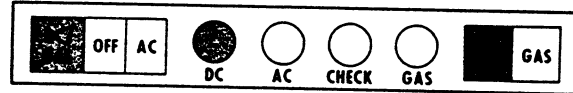

1. 12 volt DC supply must be on at refrigerator to operate on DC.
2. Turn thermostat to mid range position.
3. Depress GAS-ELEC switch to ELEC position; depress DC/GAS-OFF-AC switch to DC position. Amber light will indicate the refrigerator is operating properly in the DC mode. (Amber light confirms 12 volts and remains on when the thermostat is satisfied.)

## SHUT DOWN INSTRUCTIONS – GAS OR ELECTRIC

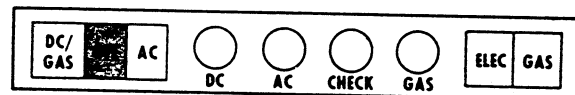

Refrigerator is shut down by depressing DC/GAS-OFF-AC switch to OFF. Indicator lights will be off.

## MODE SELECTOR

The Mode Selector allows selection of either gas or 110 volt energy source. (And, in case of EG3 models, gas, 110 volts AC or 12 volts DC).

Should you lose one of these sources, you can quickly switch to another source with the Mode Selector. The Mode Selector will indicate a loss of the operating mode as follows:

- (a) If the refrigerator has been operating on 110 volts AC and the power is lost (or the shore line is unplugged), the green light will go off even though the switch is pressed to electric.
  - (b) If the refrigerator has been operating on gas and the flame is lost (empty gas bottle or valve turned off, etc.), the red check light will come on, in addition to the blue light.
- NOTE:** If the blue light goes off while still in the gas mode, this indicates loss of the 12 volt control voltage.

- (c) If the refrigerator (EG3 models only) is operating on 12 volts DC and the power is lost, the amber light will go off even though the switches are pressed to DC and electric.

### REFRIGERATOR DOOR LOCK

To open or close the doors, push the lock fully to the right (red lock indicator screw covered - Figure A), being certain that the lock mechanism tab clears the lock mechanism slot (Figure B). If these procedures are not followed, the lock mechanism tab will break. Never attempt to open or close the doors without the lock slid totally to the right (red lock indicator screw covered - Figure A).

To lock the refrigerator door, being certain the door is completely shut, slide the lock totally to the left (red lock indicator screw visible - Figure C).

Figure A

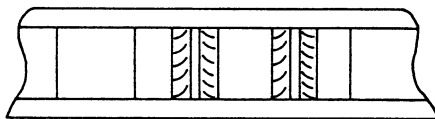

Latch in Open Position

Figure B

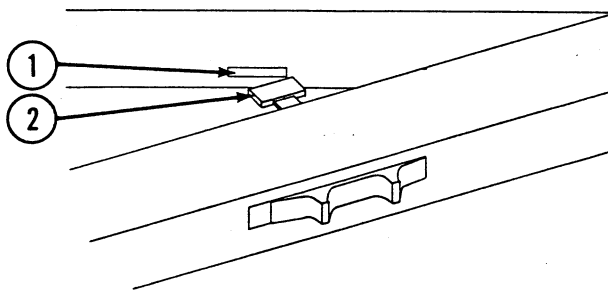

1. Lock Mechanism Slot
2. Lock Mechanism Tab

Figure C

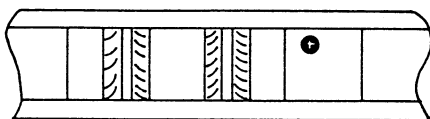

Latch in Locked Position

### DEFROSTING THE REFRIGERATOR

After a period of operation, frost may gradually accumulate on the freezer plate and the cooling fins in the food compartment. This frost accumulation, if not periodically removed, will impair

the efficiency of the refrigerator. Should frost be allowed to continually build up on the cooling plates, it acts as an insulator preventing the cooling plates to efficiently remove the heat created by door openings and the storage of foods. Periodic defrosting is therefore necessary for efficient and economical operation.

To defrost the refrigerator on gas or electric operation, turn the thermostat to the "Off" position. Empty the ice cube trays and fill them with hot water placing them on the cooling plate. This will accelerate the defrost cycle. When all frost has melted, empty the drip tray from beneath the finned evaporator and wipe up the excess moisture with a clean cloth. Replace the drip tray and all the food stuffs; then place the refrigerator into operation. Set the thermostat to its coldest setting for a few hours for maximum cooling before returning it to its normal position.

### CAUTION

Do not use metal or sharp objects to remove frost accumulation, as damage to the interior surfaces may result.

### CLEANING THE REFRIGERATOR

Cleaning the interior of the refrigerator should only be done using a mild soda solution. Do not use harsh or abrasive type cleaners as they will attack the surface of the plastic and aluminum surfaces.

It is important to maintain the cabinet in a cleanly state to eliminate the possibility of food odor.

### WATER HEATER

#### Pilot Ignition Water Heater

Access to the water heater and its controls is on the outside of the vehicle. A safety valve on the water heater automatically shuts off the gas should the pilot blow out from vehicle motion.

#### Controls

Two types of gas valves are used on the water heater units, depending on availability. When lighting the pilot and operating the controls, refer to the instructions and illustrations pertaining to the type of control valve used in your motor home.

## ROBERT SHAW CONTROL

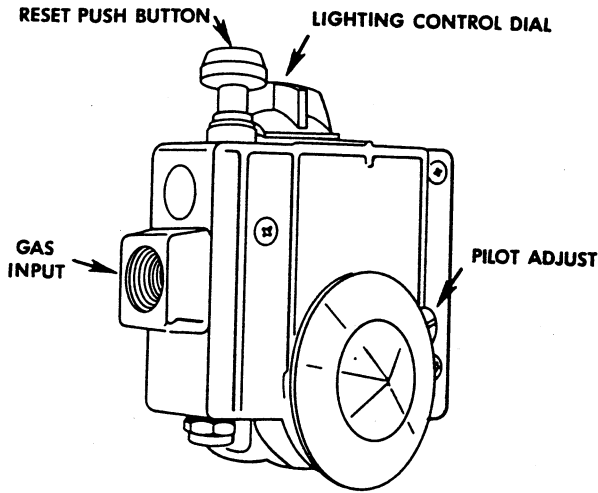

### Control Functions

**Gas Control Dial** - The dial has two positions in addition to "Off". Gas flows to the pilot only when the dial is in the "Pilot" position for lighting. The "On" position allows gas flow to the pilot and main burner after the pilot has been lit. The "Off" position is used for complete shutdown.

**Reset Button** - When held down, the reset button allows gas flow to the pilot and resets the thermostat safety valve.

**Temperature Dial** - Allows selection of the desired water temperature.

### Lighting Instructions

#### WARNING

When relighting extinguished pilot flame, turn gas control valve to "Off" and wait five minutes before proceeding.

1. Turn gas control valve to "Pilot" position.
2. Depress and hold reset button while lighting pilot burner. Allow pilot to burn approximately 30 seconds before releasing reset button. If pilot does not remain lit, repeat operation and wait longer before releasing reset button.
3. Turn gas control dial to "On" position and turn temperature dial to the desired position.

## ITT CONTROL (JADE)

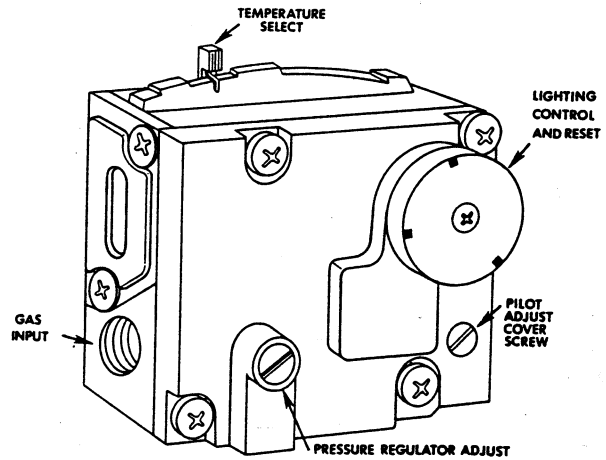

### Control Functions

**Lighting/Control Dial** - This dial has three positions which control gas flow to the pilot and burner. The "Off" position is used for complete shutdown. When the dial is placed in the "Pilot" position, gas is permitted to flow to the pilot only. Holding the dial against the spring loaded stop at "Pilot" opens the gas flow and resets the thermomagnet for lighting. The "On" position allows gas flow to the pilot and the main burner after pilot has been lit.

### Lighting Instructions

#### WARNING

When relighting extinguished pilot flame, turn control dial to "Off" and wait five minutes before proceeding.

1. Turn lighting/control dial counter-clockwise against spring loaded stop while lighting pilot burner. Continue to hold against stop 30 to 60 seconds until pilot remains lit after releasing dial.
2. Turn control dial clockwise to "On" for automatic control.
3. Set selection lever for desired water temperature.
4. Ensure main burner cycles on and off to maintain water at desired temperature. If burner does not cycle on and completely off, have your dealer check water heater control.

NOTE: Water temperature must be above 50°F. before the burner will cycle on and off.

**Temperature Control Lever** - This lever permits selection of the desired water temperature by setting the lever at a position between the "Hot" and "Warm" markings. Approximate temperatures for the two positions are 160°F. at the "Hot" setting and 115°F at the "Warm" setting.

## WARNING

Hydrogen gas can be produced in the water heater system served by a water heater that has not been used for an extended period of time, usually two weeks or more. Hydrogen gas is extremely flammable; due to risk of injury under these conditions, it is recommended that the hot water faucet be opened at the sink and the system totally filled before turning on the water heater. If hydrogen gas is present in the water system, there will probably be an unusual sound such as air escaping through the pipe as the water begins to flow. NEVER smoke or allow open flames near the faucet at the moment it is first turned on after an extended idle period or refilling of an empty system.

## ELECTRIC IGNITION WATER HEATER, MOTOR AID AND REAR AUTOMOTIVE HEATER-OPTIONAL

Some motor home models may be equipped with the electric ignition water heater, motor aid and rear automotive heater package.

### Electronic Ignition Water Heater

When a flame is needed, an electrical circuit opens the gas valve, operates a spark ignitor, and starts the burner flame. When water has been warmed to the set temperature, the gas flow will be cut off and the flame will be extinguished. The burner flame will continue to cycle, as long as the control switch is on, each time there is a demand for hot water.

To start the water heater:

1. Place switch to the "On" position.
2. If switch light comes on, place the switch to the OFF position, and wait 30 seconds. Repeat step 1. The appearance of the light indicates the burner has not ignited.

## IMPORTANT

It may take more than one start attempt when the unit is being used for the first time or after the LP tank has been refilled.

3. Leave the switch in the "On" position as long as hot water is desired.

## IMPORTANT

Always return the switch to the "Off" position when the water heater is not being used.

The water heater is also equipped with a manual reset automatic gas shutoff which is by high temperature and shuts down whenever overheating occurs. To reset the unit:

1. Position control switch in "Off" position.
2. Remove junction box cover at rear of unit.
3. Depress red button on limit switch.
4. Replace cover on junction box.

## IMPORTANT

Be sure cover insulation is in place when replacing cover.

## Motor Aid

The motor aid acts as a heat exchanger between the water heater and the vehicle engine. Two hoses from the water heater connect to the hoses which deliver hot water between the engine and the driver's compartment heater. A heat exchanger unit in the water heater then circulates the water from the engine radiator around the water heater tank. Therefore, it is not necessary to have the water heater on while the motor home is in motion. Under normal conditions, the entire contents of the water heater tank will be heated to approximately 140°F. in about two hours or 100 miles of driving.

In addition, the motor aid heat exchanger helps the vehicle engine to operate at cooler temperatures by dispersing heat from the engine. This reduces the possibility of overheating, particularly when operating in hot climates.

## Auxiliary Rear Automotive Heater

The rear automotive heater is provided to heat the rear of the unit while the vehicle is in motion.

The left control operates the three speed fan with the high speed being obtained when the knob is rotated to the full clockwise position. The right knob controls the volume of air flow. The amount of heat increases as the knob is pulled out. Pushing the knob all the way in shuts off all heat.

## VACUUM CLEANER (Optional)

The vacuum cleaner requires 110-volt current for operation. To use the vacuum cleaner, connect the motor home to an external power source or start the 110-volt generator.

The vacuum cleaner has no on and off switch, but is started simply by raising the flap on the outlet and inserting the hose with a slight twist. Make sure the dust bubble has been connected to the hose; then connect the wand and the desired attachment to the bubble. To shut off the unit, remove the hose from the outlet and close the cover flap; the vacuum motor will stop automatically.

The dust bubble is easily opened to empty contents and change filters when necessary. To open, hold the dust bubble over a trash container and twist the lid carefully. Empty the contents and tap the two halves to release any dirt trapped on the filters. The dust bubble can be rinsed out with water after upper and lower filters have been removed. After rinsing, wipe the bubble dry and return both filters to their original positions.

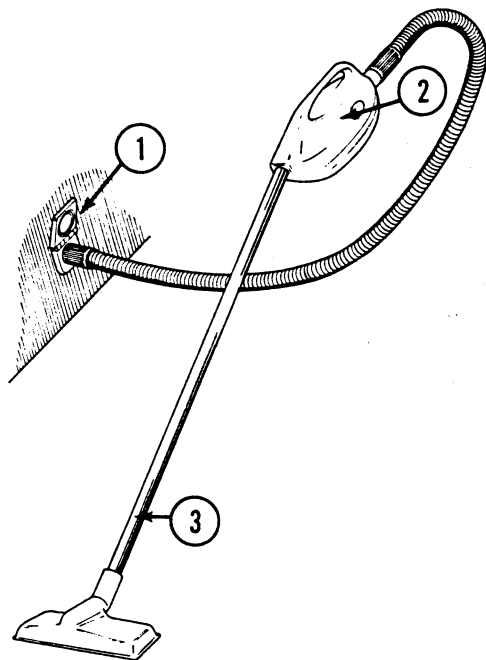

### VACUUM CLEANER

1. Wall Outlet
2. Filter Bubble
3. Extension

## Removal and Repositioning of Filters

**To Remove Filters** - With the lid removed, grasp the large outer ring in the upper bubble half and pull gently until free. Lift out the small inner ring from the center of the bubble and carefully remove the upper filter. To remove the lid filter, grasp the lid filter ring and remove by pulling gently.

**To Reposition Filters** - Slide the small inner ring onto the red collar on the upper bubble half and push in all the way. Position the large outer ring on the flange (lip) just below the dust bubble ring. Make sure the ring engages the flange all around the bubble. When properly positioned, the large outer ring should rotate freely on the flange. To replace the lid filter, position the filter ring on the flange and push in.

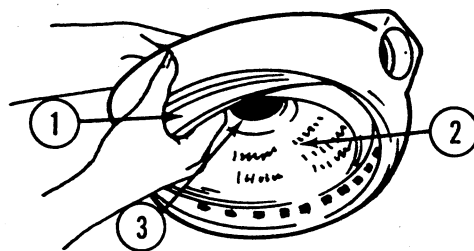

### FILTER REMOVAL

1. Large Outer Ring
2. Filter
3. Small Inner Ring

### WARNING

Electric shock could occur if the vacuum is used outdoors or on wet surfaces.

## ROOF AIRCONDITIONER (Optional)

The roof air conditioner is operated totally from the control panel on the inside ceiling assembly. The temperature control regulates the on and off temperature setting at which the compressor (or heater, on the Elect-A-Heat model) will operate. The selector switch operates the air conditioner on the desired mode ("Off", "Heat" on Elect-A-Heat models, "Fan Only" and "Cooling").



Those air conditioner units with the controls on one end, have a lever control which operates the damper to regulate the volume of air being circulated during the "Fan Only", "Cooling" or "Heating" (on the Elect-A-Heat model).

The 13,500 BTU roof air conditioner incorporates a rotary compressor as compared to a reciprocating compressor. The rotary compressor is much smaller and therefore several pounds lighter in weight.

The housing of a reciprocating compressor contains suction gas and will run cool. The rotary compressor however, contains discharge gas and will run hot to the touch. This condition is normal.

The torque required to start the rotary unit is much lower, therefore there will be less chance of starting failure, should low voltage conditions occur.

The 13,500 BTU rotary compressor unit will tend to run quieter and smoother and will also start and stop more smoothly.

### To Operate For Cooling

Set the selector switch to the "Low Cool" or "High Cool" position of the dial. The fan will run continuously to filter and circulate the air throughout the vehicle. Setting the damper control lever at "High" will provide the greatest volume of air circulation, while setting it at "Low" will provide a lower volume of air. Setting the damper control lever any place between "High" and "Low" can provide almost unlimited control over the volume of cooling air flowing from the air conditioner.

Set the temperature switch to provide a temperature level that is comfortable. The compressor will automatically turn on when the temperature of the air entering the air conditioner rises a few degrees above the selected setting. The compressor automatically turns off when the temperature of the air entering the air conditioner drops a few degrees below this setting. The air conditioner will keep cycling the compressor on and off in this fashion until the selector switch is changed to another mode of operation. During this time, both the air recirculation system and the refrigerant system will be in operation to provide filtered, dehumidified, cold air in the volume desired.

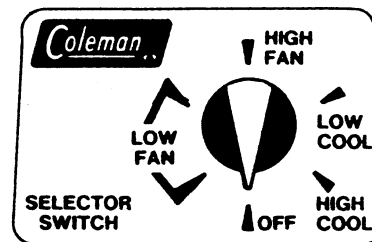

COOLING ONLY MODELS

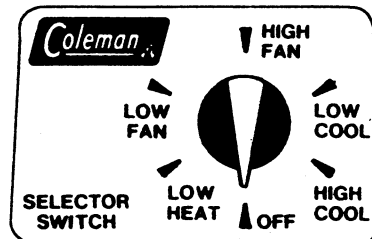

COOLING AND HEATING MODELS

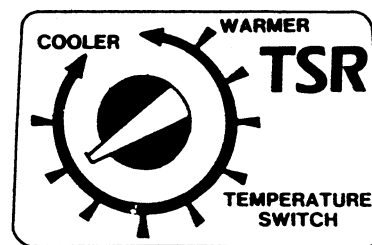

ALL MODELS

### To Operate for Heating (Elect-A-Heat Model Only)

Set the selector switch to the "Low Heat" position. The fan will automatically start circulating air continuously at a low volume.

Set the temperature switch to the temperature level that is comfortable. The heater automatically turns on when the temperature of the air entering the air conditioner drops below this setting a few degrees and automatically turns off when the temperature of the air entering the air conditioner rises a few degrees above the selected temperature setting. The air conditioner will keep cycling the heat on and off in this fashion until the selector switch is changed to another mode of operation.

### To Operate for Air Recirculation Only

Set the selector switch to the "Low Fan" or "High Fan" position on the dial. The fan will run continuously and filter the air without either cooling or heating it. To obtain a lower or higher volume of circulating air, simply raise or lower the damper control lever. This will close or open the damper in the air conditioner unit to provide

almost unlimited control over the volume of air being recirculated in the motor home.

### To Operate as a Dehumidifier

In some areas where higher relative humidities are experienced, it is desirable to operate your unit primarily for humidity control. To operate the air conditioner as a dehumidifier, set the selector switch at the "Low Cool" or "High Cool" range with the air damper at either medium or high setting.

Set the temperature switch to the warmest position at which the compressor will cycle on and off for cooling. When operated in this position, your air conditioner will remove high quantities of moisture from the air without cooling the motor home.

Any time the unit is operated on either full cooling or as a humidity control appliance, the excess moisture removed from the air stream in the motor home will be diverted onto the roof. Do not be alarmed as this excess moisture is allowed to escape from the area of the air conditioner to the ground.

### Roof Air Conditioner Maintenance

#### FILTERS

The filters are located in the interior ceiling shroud and are easily accessible for changing and/or cleaning. Remove and clean filters approximately every two weeks of operation:

1. Remove control knobs.
2. Remove shroud attachment screws.
3. Lower shroud from ceiling.
4. Remove filters, clean with soap and water and rinse clean.
5. Dry the filter carefully and reinstall.
6. Replace ceiling shroud, screws and control knobs.

#### CAUTION

Do not operate the air conditioner for extended periods of time without the filters installed.

### CIRCUIT BREAKER

The air conditioner unit is protected from current overload by a circuit breaker located on the motor home electrical control panel. Move switch to "Off" position and back to "On" to reset breaker.

### AIR CONDITIONER SELECTOR SWITCH W/ICN30RT and W/ICN33RU (Optional)

It is only possible to operate one air conditioner at a time off of the external 110-volt supply (power cord). To allow the owner the choice of running either the front or rear air conditioner, an air conditioner selector switch has been incorporated into the unit. To operate the air conditioner, simply turn the rotary style switch to the "front" position to operate the front air conditioner, and turn the rotary switch to the "rear" position to operate the rear air conditioner. The air conditioner selector switch is mounted into the cabinet face near the power control center.

The 110-volt auxiliary generator has the capability of running both air conditioners simultaneously without encountering an overload problem. To operate both air conditioners simultaneously, you must have the power cord plugged into the generator receptacle. To operate both air conditioners, first turn on the generator, then position the air conditioner selector switch to the "front" position, then turn on the two individual air conditioners. By following these procedures, the generator set will start with less difficulty.

### TV Antenna With Built-In Amplifier (Optional)

The TV antenna with your unit can be easily raised, rotated a full 360° and lowered from inside the vehicle by simply turning a crank or the rotating disc. Another positive feature is the built-in signal amplifier designed to strengthen signals, which is controlled by the power switch built into the TV jack assembly.

The amplifier is housed inside the antenna with the circuit board connected directly to the antenna elements. Power to operate the amplifier (12-volt D.C.) is supplied through the downlead cable which also carries the TV signals to the TV set. The power supply separates the 12-volt D.C. from the TV signals and provides a place for attaching the TV set and the 12-volt power source.

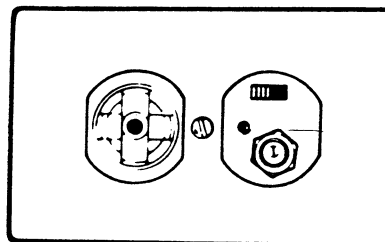

## OPERATION

**Raising Antenna** - Turn elevating crank (clockwise) in "UP" direction about 13 turns or until some resistance to turning is noted. Antenna is now in operating position. Check to assure power supply switch is "ON".

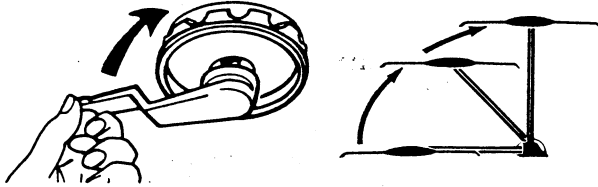

**Rotating Antenna** - Make sure antenna is in the "UP" position. Pull down on rotating knob until it disengages ceiling plate and rotate for best picture and sound on TV set.



**Lowering Antenna to Travel Position** - Rotate antenna until pointer on rotating knob aligns with pointer on ceiling plate.

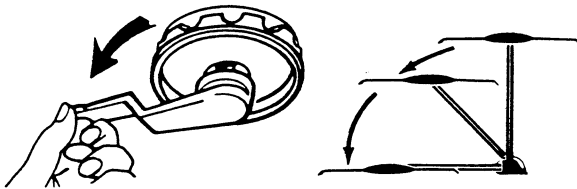

### CAUTION

Never lower antenna in any position except travel position.

Turn elevating crank (counterclockwise) in "DOWN" direction until resistance is noted. Antenna is now locked in travel position. Return power supply switch to the "Off" position.

Count number of turns necessary on elevating crank to lower antenna until head is just resting on the roof of the vehicle. Mark position of elevating crank on ceiling or directional handle and number of turns (about 13). Use this number of turns when raising or lowering and stop at mark.

### CAUTION

Always align directional handle to "DOWN" position before lowering.

## AMPLIFIER

To operate amplifier, turn on power switch located on 12-volt receptacle mounted on the bottom side of an overhead cabinet.

## CHECKING PERFORMANCE

The TV signals available to an RV are entirely dependent on its' location with regards to the transmitter. Signals may vary from very strong to no useable signal at all. We recommend that the TV system be checked out in an area known to have good TV reception.

## IMPORTANT

Very strong signals can cause poor reception due to overload. In the event the unit is operated very close to a transmitter it may be best to disconnect the lead-in wire from the television set and use the built-in antenna.

To check an amplified antenna, raise antenna to operating position, turn TV to station and rotate antenna for best picture. Now, turn off switch at power plate or disconnect power from TV system. If antenna is working, TV picture will be degraded (snowy).

### WARNING

Observe antenna height while parked, to prevent contact with electrical wires, power lines, etc.

## MONITOR/CONTROL PANELS

The monitor/control panels provide a centralized location of holding tank, water tank and LP gas level switches. Controls for the demand water pump and a digital clock are located on the panels. Refer to the Monitor/Control Panel illustrations and associated functional descriptions for operating procedures.

**Water Pump Switch** - When use of the internal water system is desired, simply place the switch in "on" position. A light above the switch is lit when the pump switch is on and the system is operable. Water will be available as soon as a faucet is opened. Refer to "Internal Water System"

on page 66 for more information on the water pump and initial start-up of the system.

**Water Tank, Holding Tank and LP Gas Level Switches** - Each of the tank monitor switches is linked to a series of five indicator lights on the panel. When a switch is depressed, all lights to the correct level will illuminate to indicate the liquid level in the corresponding tank. If the tank is more than half full, but less than three-quarters, the gauge will register half full. This applies for all markings on the gauge as well. Since the level is measured by electric probes in the water and holding tanks, the liquid must be level with, or above the probe to be registered. There may or may not be water left in the water tank when the gauge registers "O" (empty), since the "1/4" light will go out and only the "O" light remains illuminated as soon as the water level drops below the one-quarter level. LP gas level is registered on the panel via a pressure sending unit on the tank. The LP gas level is also registered by a gauge at the tank location.

**Refrigerator Alarm (if equipped)** - Should the burner on the refrigerator go out while operating on LP gas, the "Ref" light on the panel will

illuminate. This provides a warning to restart the unit or change to electric operation before food spoilage can occur. Place the switch in "Off" position to shut off the alarm; restart the refrigerator, and place the refrigerator alarm switch to the "On" position. This alarm is not available on units equipped with an electronic ignition refrigerator.

**Clock and Controls** - A digital clock is located on the panel for your convenience. A switch on the right side allows the clock to be reset to the correct time. Depress the "hours" switch to advance the hour setting and the "minutes" switch to change the minutes reading. A switch on the left side allows the clock display to be shut off. However, the clock mechanism will continue to operate, keeping the correct time. To operate the alarm, push the switch labeled "ALARM" to the "ON" position. To set the alarm, push the "ALARM SET" switch and the "hours" and "minutes" switch simultaneously to the desired time. A small light will illuminate on the digital readout panel to specify AM or PM settings, and another light will illuminate when the alarm is in operation.

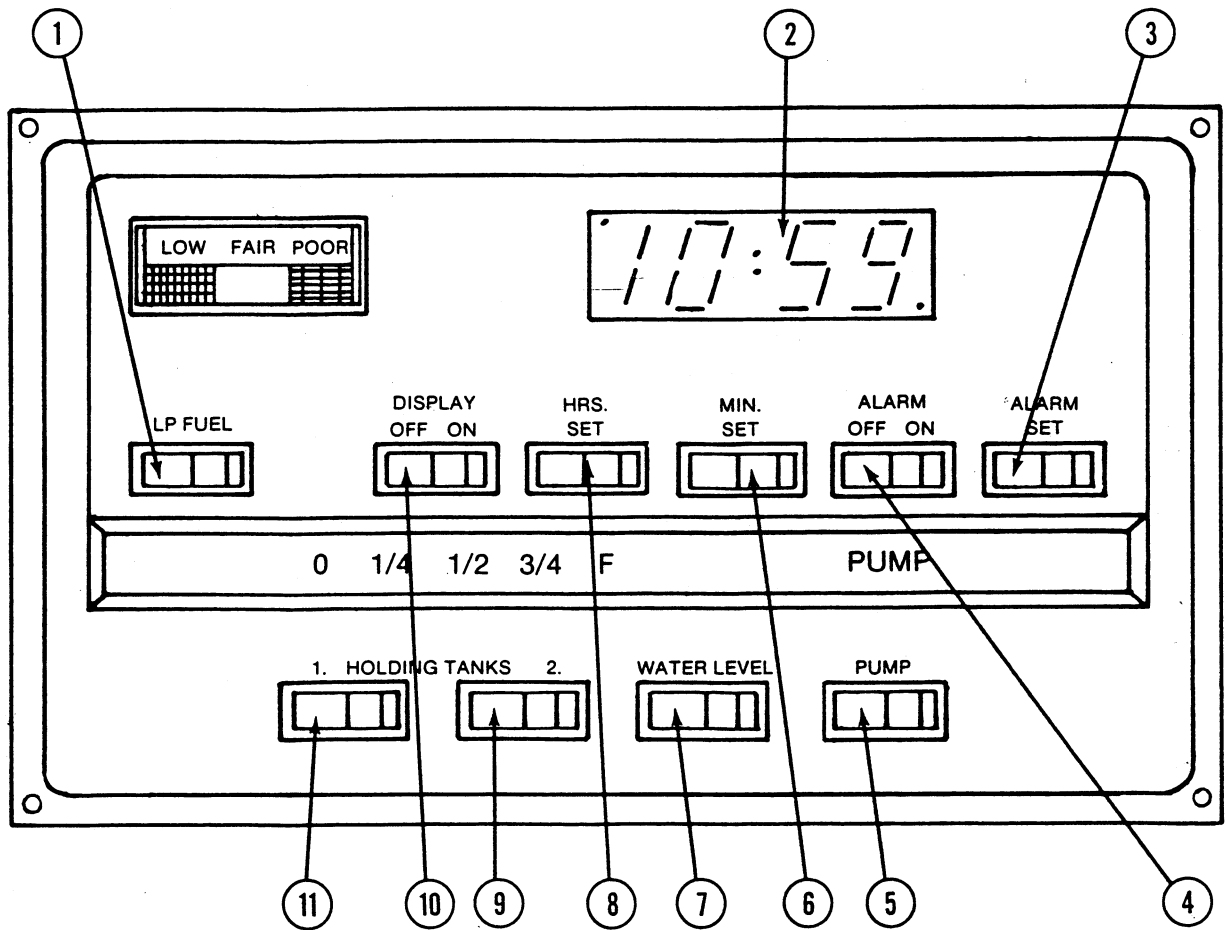

**MONITOR/CONTROL PANEL**

1. LP Gas Level Switch
2. Digital Clock
3. Alarm Set Switch
4. Alarm Off/On Switch
5. Water Pump Switch
6. Minutes Set Switch
7. Water Tank Level Switch
8. Hours Set Switch
9. Waste Water Tank Level Switch
10. Clock Display Switch
11. Sewage Tank Level Switch

## MONITOR CONTROL PANEL (OPTIONAL)

The Monitor/Control panel is incorporated into the range exhaust vent face. It provides a centralized location of holding tank, water tank and LP gas level switches and indicator lights. It also includes controls for the water pump, electronic ignition water heater, range hood light and fan, and a digital clock. Refer to the Monitor/Control Panel illustrations and associated functional descriptions for operating procedures.

**Water Pump Switch** - When use of the internal water system is desired, turn the "Panel Power" switch on and turn the "Water Pump" switch to on. A light in the center of the panel will illuminate when the pump switch is on and the system is operable. Water will be available as soon as a faucet is opened. Refer to the "Internal Water System" on page 66 for additional information on the water pump and initial start-up.

**Water Heater Switch** - When the use of hot water is desired, turn the "Panel Power" switch on and turn the "Water Heater" switch to on. A light in the center of the panel will illuminate when the water heater switch is on and the water heater is operating. Refer to "Electronic Ignition Water Heater" for further information on the water heater.

**Water Tank, Holding Tank and LP Gas Level Switches** - Each of the tank monitor switches is linked to a series of five indicator lights on the panel. When a switch is depressed, all lights to the correct level will illuminate to indicate the liquid level in the corresponding tank. If the tank

is more than half-full, but less than three-quarters, the gauge will register half full. This applies for all markings on the gauge as well. Since the level is measured by electric probes in the water and holding tanks, the liquid must be level with, or above the probe to be registered. There may or may not be water left in the water tank when the gauge registers "O" (empty), since the "1/4" light will go out and only the "O" light remains illuminated as soon as the water level drops below the "1/4" level. The LP gas level is registered on the panel via a pressure sending unit on the tank. The LP gas level is also registered by a gauge at the tank location.

**Clock and Controls** - A digital clock is located on the panel for your convenience. To view the clock, turn on the switch labeled "Display On". To set the clock to the proper time, depress the "Hours Set" switch to change the hour and the "Minutes Set" switch to set the minutes. A switch on the left side allows the clock display to be shut off. However, the clock mechanism will continue to operate, keeping the correct time. To operate the alarm, push the "Alarm Set" switch and the "Hours Set" and "Minutes Set" switch simultaneously to the desired time. A small light will illuminate on the digital readout panel to specify AM or PM settings, and another light will illuminate when the alarm is in operation.

**Hood Fan and Light Switches** - To turn on the range hood light, simply push the switch labeled "Hood Light". To operate the range hood fan, push the "Hood Fan" switch towards "High" or "Low" depending upon the volume of exhaust desired.

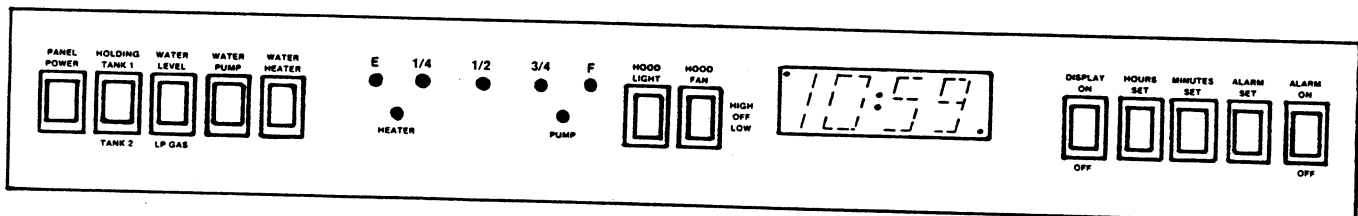

# INTERIOR FURNISHINGS

Due to various floor plans available on motor homes, the following interior furnishings may or may not be applicable to your vehicle.

## WARNING

Sleeping facilities are not to be utilized while vehicle is in motion.

### FRONT PULL-DOWN BUNK

A pull-down bunk is optional on all A-body motor homes to provide additional sleeping capacity. The spring balance bunk is mounted above the driver's compartment and is moved into position by pulling downward in an arc. The bunk has two seat belt type fasteners which ensure against bunk movement while traveling. Before moving the bunk into the lowered position, unsnap the fasteners and make sure the sunvisors are out of the way. When returning the bunk to the raised or stored position, check to be sure there are no loose items on the mattress which might strike the ceiling when raised; then snap fasteners to secure the bunk against the ceiling.

### DINETTE/BED

A combination dinette and bed is provided in some models. To convert to a bed:

1. Fold table leg up against bottom side of table by releasing catch.
2. Relocate table by lifting the end nearest the aisle to release it from support bracket on sidewall. Then lower table to rest on cleats attached to each dinette bench.
3. Arrange dinette back and seat cushions over bed area.
4. To convert dinette/bed back to a table, reverse the above procedure.

### OVERHEAD BUNK (C-Body Motor Homes Only Except WC723RB)

The overhead bunk located above the driver's compartment allows easy access to and from the driver's compartment seats when in the stored position, but easily converts to a full-size bed as follows:

1. Grasp loop on top section of mattress and carefully unfold to cover driver's compartment.
2. To stow bed after use, fold rear mattress section forward onto front section.

### SIDE PULL-DOWN BUNK (Optional on WC723RB)

A side pull-down bunk is optional on the above models only. The bunk provides additional sleeping accommodations for one (1) person and is moved into position by pulling downward in an arc. When returning the bunk to the raised or stored position, check to be sure there are no loose items on the mattress which might strike the ceiling when raised.

## WARNING

The side pull-down bunk on these models is designed to accommodate one (1) average adult only. Damage to equipment may result if more than one (1) person uses this bunk at one time.

## WARNING

The side pull-down bunk is intended for use only when the vehicle is parked. Use of this bunk while the vehicle is in motion can cause damage to equipment and/or personal injury.

### SLIDE-OUT COUCH

To convert the slide-out couch to a bed:

1. Grasp edge of slider assembly, lift up and pull out to the full extent as you would a drawer. The bottom cushion will be pulled out with the slider.

### IMPORTANT

On some models, it will be necessary to remove the pedestal tables before pulling out the slider assembly. Refer to steps 1 to 3 of "Pedestal Dinette Table".

2. While pulling out the tray, lower back cushion support board to rest on couch frame.
3. Make sure all cushions lay level over the bed area.
4. To convert the bed back to a couch, simply lift back support board while sliding support tray back against the wall.

## **CONVERTIBLE COUCH**

The convertible couch is designed to be a comfortable couch plus a bed. To change the couch into a bed, simply lift up and pull out on the seat cushion assembly while gently pushing down on the backrest cushion. The seat cushion assembly must be pulled out until it locks into place, forming a comfortable sleeping surface. To turn back into a couch, lift up on the front of the seat cushion assembly and push back evenly until the assembly locks into the upright position. Always make sure that the couch is locked into position before use.

## **PEDESTAL DINETTE TABLE**

To remove and store the pedestal dinette table:

1. Remove table top by lifting while also giving

- a gentle twist or rocking motion to the top.
2. Remove pedestal(s) from the socket with a gentle lifting, turning motion.
3. Store the pedestal(s) in one of the closets or wardrobes.
4. Install carpet covered floor socket plug into floor socket.

## **FOLD UP TABLE**

The fold up table is stored in an assembly against the wall between the swivel chairs. To use or store the table:

1. Lift the bottom of the table upward, lower and lock the leg, set table on the leg and table is in place.
2. To store, lift the end of the table, fold up leg and lower table into assembly.



# MOTOR HOME CARE AND MAINTENANCE

## ROOF

Like the walls and floor, the roof is made of Thermo-Panel® construction. It may support your weight, should it become necessary to repair the roof or roof mounted components. It is not recommended, however, that very large or heavy objects be carried on the roof when the vehicle is in motion. Always have sealant around the vents, air conditioner, body to roof seams etc., or damage to the roof area repaired immediately. If you do not feel capable, have it repaired by your dealer immediately. Putting off these repairs can allow water leakage and result in further damage to interior ceiling and body panels, upholstery, etc.

### WARNING

Before climbing on the roof to do repairs be certain to check roof weight specifications on pages 7-9.

### CAUTION

The sealants must be checked every 6 months and resealed if necessary.

## UNDERBODY

Corrosive materials such as those used for ice and snow removal and dust control often accumulate on the underside of the vehicle. The buildup of mud under the body not only can cause rust, but also adds weight which contributes to the gross vehicle weight of the vehicle. This, in effect, reduces the amount of cargo you can carry to stay within the GVWR and GAWR limits.

These materials should be removed by flushing the underbody regularly with water, especially those areas where mud and other foreign materials collect.

## EXTERIOR

The exterior surface of your motor home has an automotive enamel finish. Frequent washing and thorough cleaning is recommended to prevent damage to the vehicle finish after exposure to damaging salts, calcium chloride, road tar, tree sap, insects and other foreign material. Never wash the vehicle with hot water, in the direct rays of the sun or when the sheet metal is hot. Never wipe dirt from a dry painted surface without first washing the vehicle, as this may scratch the paint.

Do not use strong soaps or detergents for washing the motor home. Always use a mild soap in warm water, a commercially prepared product for cleaning automotive finishes or your local car wash.

After washing the motor home, look carefully for cracks in the seams and caulking that has dried and split around window frames and vents and any other joints that may have separated. Re-caulking, if necessary is quite simple. Appropriate compounds are sold in most R.V. Stores and the material is quickly and easily applied. Also, inspect weather seals around door, etc., and if necessary have a dealer replace them immediately.

Always check lighting and be sure that the clearance lights and turn indicators are all working.

### CAUTION

The sealants must be checked every 6 months and resealed if necessary.

### CAUTION

Never use a strong solvent such as lacquer thinners or harsh abrasives on painted surfaces.

### CAUTION

Always check for sufficient overhead clearance before entering a car wash area.

It is recommended that a coat of automotive wax be applied to the surface occasionally to provide added protection against harmful deposits coming in contact with the paint.

## UPHOLSTERY AND CARPETING

Dust and loose dirt that accumulates on upholstery and carpeting should be removed frequently with a vacuum cleaner, whisk broom, or soft brush. Wipe any vinyl plastic surfaces with a soft damp cloth. Always remove spots and stains as soon as possible. Stains or soils such as lipstick, inks, grease and mustard are extremely difficult to remove. Consult a professional carpet and upholstery cleaner for assistance.

## **WARNING**

When cleaning upholstery, carpeting and fabric, do not use lacquer thinner, nail polish remover, laundry soaps, or bleach. Never use carbon tetrachloride, gasoline, or naphtha for any cleaning purpose.

These materials may cause damage to the material being cleaned and most are highly flammable.

When cleaning any stain, use a small amount of cleaner, light pressure and a clean cloth. Work from the outside of the stain toward the center, frequently changing the cloth to a clean section. Immediately wipe the area briskly with a clean absorbent towel or cheese cloth to dry the area. Any stains or soils in the carpet should be removed by following the directions on a good quality carpet cleaner or shampoo.

### **IMPORTANT**

To minimize fading of upholstery caused by excessive sunlight, the drapes should be pulled closed when the motor home is parked for an extended period of time.

### **FABRIC DRAPERIES**

The fabric draperies contained in the motor home are made of various fabrics. It is recommended that they be cleaned by a professional dry cleaning service.

### **WOVEN WOOD DRAPERIES (Optional on some models)**

Vacuum the draperies frequently to prevent dust build-up. If the draperies become soiled, sponge off the fabric with a solution of warm water and mild detergent. Use care not to soak the fabric, especially the fringe trim. Very stubborn or ground-in stains can be removed with a household stain remover. Test stain remover on a small hidden area before using it on the entire shade. Bleach or strong household cleaners must never be used.

If cords become difficult to pull, check alignment of cords in pulley mechanism of shade or traverse rod of drapery. Do not force the mechanism as further binding will occur. Should one side of the shade raise more than the other, simply adjust the cord equalizers. If a strand of yarn slips off the edge of the wood slats, remove that strand entirely.

## **WORK SURFACES**

Work surfaces are covered with a plastic laminate that is resistant to solvents, stains and abrasions. A coat of wax applied to these surfaces on the counter and table will help preserve their beauty and make cleaning easier. Always clean the surface before applying wax.

### **STAINLESS STEEL SINK**

The stainless steel sink can be cleaned with soap or detergent. Rinse thoroughly with warm water and wipe dry to avoid streaks.

Use a mild abrasive for stubborn stains. Work in the direction of the polish lines. To keep the original finish, polish with a wax cleaner and rub with a soft dry cloth.

## **CAUTION**

Salt, mustard and mayonnaise may cause pitting. If spilled, clean immediately.

## **WALLS AND CEILING**

Wall and ceiling paneling can be cleaned with a mild soap or detergent solution. Use a damp cloth, but do not saturate the walls with water. To minimize fingerprints and smudges on the walls, use a cleaner on the paneling that leaves a film of thin wax. Wipe the wax cleaner on and then remove any excess with a dry cloth. After this application, fingerprints and etc., can be wiped off with a dry cloth, or one moistened with a little additional wax cleaner. Always clean the wall surface thoroughly before applying the wax.

## **RANGE AND REFRIGERATOR**

For care and appearance maintenance of the range and refrigerator, refer to the operation and maintenance section for each of the individual appliances.

## **BATHROOM**

The shower walls in the bathroom should be cleaned with a mild soap and water solution or to obtain maximum luster, use a good quality wax cleaner. Do not use an abrasive cleaner on the shower walls. However, a mild abrasive cleaner may be used to clean the shower floor or bathtub. If the shower has a Plexiglas door, it is extremely important that abrasives or solvents and aromatic spirits that contain a petroleum base or additive not be used. These products can cause a reaction with the glass that results in visible deterioration marks. Use only a mild detergent and water solu-

tion and a soft cloth to clean the Plexiglass surfaces.

For instructions on the care of the fresh water toilet, refer to "Toilet Maintenance", pages 70 and 71.

The bathroom vanity in some models is constructed of a plastic material and should be cleaned with a mild soap and water solution. Abrasive cleaners or harsh detergents should not be used. If the vanity sink is stainless steel, follow the directions given for care of the kitchen sink.

## DOORS AND WINDOWS

Windows can be periodically cleaned with a good quality glass cleaner or mild soap solution and a soft cloth. Use care when removing ice or frost from the windows. Always use a plastic ice scraper, never one made of metal. Use care when removing ice from the mirrors to protect the reflective surfaces.

The door locks and hinges should be lubricated periodically with powdered graphite to ensure trouble-free operation and to protect against freeze up.

### CAUTION

It is recommended that the windows, door seams, joint sealants and trim be checked every 6 months and resealed if necessary.

The following check list has been prepared by Winnebago Industries' Customer Service department for your guidance. Read the owners manual before making these checks. For items which you cannot do yourself, check with your Winnebago or Itasca dealer for service.

### EVERY 3 MONTHS

Demand water pump

- \_\_\_ Inspect in-line filter screen

Television Antenna

- \_\_\_ Spray all moving parts and bearing surfaces with silicone spray

Sliding windows

- \_\_\_ Lubricate window sliders

Auto air conditioner and heater

- \_\_\_ Lubricate control cables

Air conditioner and alternator

- \_\_\_ Adjust drive belt tension

### EVERY 6 MONTHS

Exterior body

- \_\_\_ Check and reseal seams and around trim,

exterior vents, lights, windows and doors  
LP System

- \_\_\_ Perform pressure check at each appliance (ideally one check under cold conditions and one under hot conditions per year)

Roof mount air conditioner

- \_\_\_ Clean or replace air intake filters

Toilet

- \_\_\_ Lubricate bowl sealing blade with silicone spray

Range hood

- \_\_\_ Clean filter

### EVERY 12 MONTHS

TV Antenna

- \_\_\_ Clean upper surface of rotational plate
- \_\_\_ Lubricate raising and lowering drive gears

Auto air conditioner

- \_\_\_ High side pressure charge
- \_\_\_ Low side pressure check
- \_\_\_ Clean evaporator and condenser

Roof mount air conditioner

- \_\_\_ Systems check

Demand water pump

- \_\_\_ Inspect condition of hoses and clamps. Replace if needed.
- \_\_\_ Tighten belt pulley mounting screws
- \_\_\_ Remove and clean screen of in line water filter

Gas range

- \_\_\_ Adjust and clean burner and oven pilots
- \_\_\_ Adjust and clean top and oven burners
- \_\_\_ Check alignment of oven flame spreader

Furnace

- \_\_\_ Adjust pilot
- \_\_\_ Inspect gas lines
- \_\_\_ Inspect and clean electrical connections
- \_\_\_ Inspect flue vent for obstructions or leaks around seal
- \_\_\_ Clean burner ports
- \_\_\_ Clean furnace casing interior
- \_\_\_ Clean combustion air blower
- \_\_\_ Clean circulating air blower

Refrigerator

- \_\_\_ Inspect and clean electrical connections
- \_\_\_ Inspect and adjust flame if necessary
- \_\_\_ Clean flue tube
- \_\_\_ Test safety valve performance, adjust if necessary
- \_\_\_ Test ignition, adjust if necessary
- \_\_\_ Inspect gas assembly (inspect air and burner ports, jet orifice, baffle position, igniter position, burner position and thermocouple position)

**Water heater**

- \_\_\_ Clean pilot gas and orifice
- \_\_\_ Clean and align main burner tube and orifice
- \_\_\_ Clean air intake grille
- \_\_\_ Clean "U" tube with compressed air
- \_\_\_ Clean space between two discs at end of thermocouple
- \_\_\_ Inspect and clean electrical connections

- \_\_\_ Adjust pilot and main burner flames
- \_\_\_ Inspect condition and alignment of flame spreader
- \_\_\_ Inspect plumbing and gas line fittings
- \_\_\_ Lubricate pilot button with silicone spray
- \_\_\_ Inspect heat exchanger hoses and fittings (if coach is equipped with engine heat exchanger)

# STORAGE

It is the owners responsibility to prepare the vehicle for winter storage. Your motor home is equipped with many vital systems that could be damaged due to improper storage or freezing conditions.

Proper winter storage procedures will not only lessen the possibility of costly repairs, but assure the units reliability and your continued motor home enjoyment.

After each use, it is advisable to prepare the motor home for non-use just as you would if you left your house or apartment for a period of time. Make sure all perishables have been removed from the cabinets and refrigerator. Also, make sure that proper ventilation has been provided. Always check to ensure that the LP gas tank has been turned off. It is advisable to drain the water heater, water tank and holding tanks. Close the shades to protect upholstery from the direct rays of the sun.

When preparing the vehicle for winter storage in cold climates, it is extremely important that all winterizing steps be performed.

## WINTERIZING

The objective in winterizing the motor home is to protect the various components and systems against damage from freezing. The most vulnerable areas are the water system, the drainage system, the water heater and the batteries. Perform each of the following steps to ensure that all systems have been completely drained or protected.

It is also important to wash the exterior of your motor home before storage. After washing the motor home, look carefully for cracks in the seams and caulking that has dried and split around window frames, vents and any other joints that may have separated. Re-caulking, if necessary, is quite simple. Appropriate compounds are sold in most R.V. Stores and the material is quickly and easily applied. Also, inspect weather seals around doors, windows, etc., and if necessary have a dealer replace them immediately.

1. Level the motor home.
2. Remove all foods and equipment that may cause odor.
3. Clean entire vehicle. Dirt and stains are more easily removed when fresh.
4. Close all windows and roof vents.
5. Drain the complete water system.

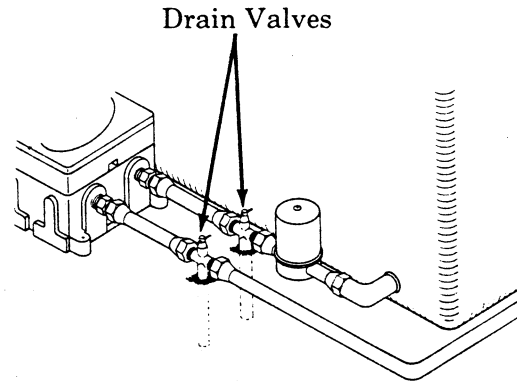

- A. Open all needle valves by pulling up on the "T" handle. Refer to water system chart for valve location (See page 105).
- B. Open all faucets and the shower head valve.
- C. Allow demand water pump to operate until all water lines have been drained.
- D. With water pump running, operate toilet flush mechanism and hold until water stops flowing.
- E. Drain water heater by opening drain valve located at base of water heater tank and accessible from the outside of the motor home. Also open the pressure relief valve, located at the top right portion of the tank. This will assist the draining and prevent air locking in the tank.

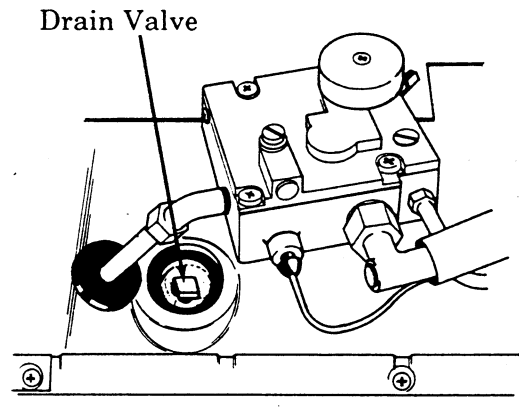

- F. Disconnect discharge and intake water lines from demand water pump. Start pump and allow to run until all water has been expelled from the unit (Running dry will not harm the pump). Then reconnect the lines.
- G. Pour dealer recommended non-toxic antifreeze into the bathroom sink drain, shower drain and kitchen sink drain(s).

## WARNING

Do not use automotive type radiator antifreeze. It is poisonous.

**NOTE:** As an alternative to system draining, all tanks and lines may be winterized with the use of non-toxic antifreeze added to the storage tank and pumped throughout the system. Follow the directions on the container to determine the correct amount of antifreeze to be used.

6. Completely drain both the waste water and sewage holding tanks. Thoroughly rinse tanks and drain again. It is recommended that when rinsing the tanks, the vehicle be driven a few blocks to make sure all material has been loosened. Close the dump valves and replace cap to prevent the dump valve shafts from rusting and to prevent rodents from entering the tank.
7. Turn furnace thermostat to "Off" position.
8. Lubricate all hinges and door locks.
9. Clean and defrost refrigerator. Leave door slightly ajar.
10. Seal all appliance vent openings.
11. Have chassis completely lubricated.
12. Disconnect battery cables from all batteries.
13. Whenever possible, the batteries should be removed and stored indoors. When they are left in the vehicle, the state of charge of all batteries must be checked regularly in areas where freezing temperatures occur. A battery will discharge by itself in time, and a discharged battery, or even one with one half charge or less, can freeze. Since the discharge time varies with temperature, battery age and other conditions, batteries should be checked at least every two weeks.
14. Make sure the antifreeze level in the automotive radiator is sufficient to protect against freezing at the lowest anticipated temperature.
15. Winterize the fresh water toilet by one of the following methods.
  - A. Leave water line disconnected at ball valve. Depress foot pedal and insert an object such as a soft drink bottle, or, ideally a tapered block of wood into the outlet located at the bottom of the bowl. Release pedal or knob slowly until the blade touches and holds the object. This will hold the water control valve open and prevent any water residue from being trapped there where it can freeze.

## IMPORTANT

If a small item, such as a soft drink bottle is used, tie it securely to prevent it from dropping into the tank.

- B. Use non-toxic antifreeze to winterize the entire motor home fresh water plumbing system. Follow the directions on the antifreeze container.
16. To extend the life of the automotive air conditioner unit when so equipped, start the motor home engine and run the air conditioner a few minutes every two weeks.
17. Prepare the optional 110 volt generator for storage by following the instructions given in the generator maintenance section. See "Storage Procedure" on page 60.

## REMOVAL FROM STORAGE AND NEW SEASON PREPARATION

1. Completely air out the motor home.
2. Check window operation.
3. Check cabinet and door hinges. Lubricate with penetrating oil, if necessary.
4. Close all faucets and drain valves that are open. If necessary, reconnect toilet water line and close flush valve.
5. Fill water tanks and check for leaks especially at junctions. Also make sure all hangers and supports are securely in place. Sanitize the water system as outlined under "Sanitizing the Potable Water System" on page 68.
6. Check operation of all faucets to be sure faucet washers have not hardened during storage.
7. Check sealing valve in the toilet for proper operation and lubricate with silicone spray.
8. Add water to the holding tank and check to be sure dump valves seal tightly.
9. Check the entire LP gas system and appliances for leaks using the leak detector. Check LP tanks for leaks using soapy water.
10. Check around all appliances for obstructions and ensure that all vent openings are clear.
11. Start refrigerator and check for proper cooling.
12. Clean paneling and counter surfaces and apply a thin coat of wax.
13. Replace batteries if necessary and check out electrical system to make sure all lights and electrical components operate.
14. Check tires for proper cold inflation pressure.
15. After washing the winters grime from the motor home it is important to carefully inspect the seams and caulking for cracks that have appeared around window frames

and vents and any other joints that may have separated. Re-caulking, if necessary, is quite simple. Appropriate compounds are sold in most R.V. stores and the material is

quickly and easily applied. Also, inspect weather seals around doors, etc., and , if necessary, have a dealer replace immediately.

## WATER SYSTEM DRAIN VALVE LOCATION

MODEL CONCERNED	WATER DRAIN VALVE LOCATION
WC420RG IC420RG	Beneath galley shelf; beneath water tank in bottom refrigerator cabinet compartment.
WC723RB	In lavatory compartment; in rear dinette seat box.
WC424RC IC424RC	Beneath shower behind false panel; in rear dinette seat.
WCN22RC ICN22RC	Beneath water tank under wardrobe; beneath shower behind false panel.
WCN23RG ICN23RG	Beneath water tank under wardrobe; beneath shower behind false panel.
WCN26RB ICN26RB	Beneath galley cabinet shelf; in bath linen closet at floor.
WCN26RH ICN26RH	Beneath galley cabinet shelf; in bath linen closet at floor.
WCN27RU ICN27RU	In bottom refrigerator cabinet compartment; beneath lavatory shelf false panel.
WCN30RT ICN30RT	Inside galley cabinet behind drawers at floor; beneath lavatory cabinet bottom shelf.
WCN30RC	Beneath shower pan behind false panel; beneath wardrobe at floor.
WCN33RU ICN33RU	Beneath lavatory; behind shower pan false panel; behind false door beneath left wardrobe.

This chart has been incorporated into this manual to assist you in locating the water system drain valves. To open the valves, pull up on the "Tee". To close the valves, push down securely on the "Tee".

# VEHICLE MAINTENANCE

## ENGINE ACCESS (C-Body Chevrolet Chassis)

The release lever to open the hood is located beneath the dashboard to the left side of the motor cover. To release the hood latch, pull out on the lever. The secondary hood latch is located on the exterior of the vehicle, below the center portion of the hood. To release, apply upward pressure to the latch and raise the hood fully, while holding fully open, attach the support rod to positioning hole in the raise hood.

With the hood open, the radiator fill and overflow, oil fill, oil dipstick, brake fluid reservoir, power steering fill, windshield washer reservoir, and air conditioner are accessible. The automotive battery is also accessible on some models.

### IMPORTANT

Refer to the appropriate sections in the Chevrolet Owner's and Driver's Manual for the requirement of the fluid level and the maintenance schedule for the components. When closing the hood, push firmly down to ensure that it latches.

## Engine Cover

The cover for the engine, located in the driver's compartment, is retained by two latches at the forward end and with screws at the floor area. Access to the air cleaner and other engine parts can be gained through this opening.

## ENGINE ACCESS (A-Body Motor Homes)

The release lever to open the hood is located on the steering column bracket near the bottom of the dash. To open, pull out on the knob and the hood will pop open. Lift up on the hood and secure it in its place with the hood hold-up rod.

With the hood open, the oil dipstick, oil fill, radiator fill, and the windshield washer reservoir are accessible.

### IMPORTANT

Refer to the appropriate sections in the Chevrolet Owner's and Driver's Manual for the requirement of the fluid level and the maintenance schedule for the following components. When closing the hood, push firmly down to ensure that it latches.

## Engine Cover

The carpeted engine cover located in the driver's compartment can be removed by releasing the latches located near the floor and then lifting it off.

Once the engine cover has been removed, the power steering fluid reservoir, transmission dipstick and fill tube, engine air cleaner and other engine parts are accessible for servicing.

## BRAKE FLUID RESERVOIR (A-Body Motor Homes)

Access to the brake fluid reservoir is located under the left front wheel well. To check the fluid level, turn the front wheel completely to the left; the reservoir is just above and ahead of the left wheel.

## ENGINE OIL

### Checking Oil Level

The engine oil must be maintained at the proper level. The best time to check oil level is as the last step in a fuel stop. This will allow the oil accumulation in the engine to drain back into the crankcase. To check the level, remove the oil dipstick, wipe it clean, reinsert it firmly and remove again for an accurate reading. The dipstick is marked "FULL" and "ADD". Maintain the oil level in the safety margin, never going above the "FULL" line nor below "ADD" line. Reseat the dipstick firmly after taking reading.

## BRAKE MASTER CYLINDER (All A-Body Motor Homes)

The brake master cylinder is located above and to the right of the left front wheel and is covered by a metal shield for protection against mud and foreign material. Have your dealer or local garage remove the shield and check master cylinder fluid level in both reservoirs every 4 months or 6,000 miles.

## ENGINE COOLING SYSTEM

The engine's cooling system has been filled at the factory with a high quality coolant containing a rust inhibitor. It has also been formulated to be used without replacement until the normal frequency for coolant change. At the end of this period, the coolant should be drained to prevent rust or corrosion in the radiator and engine, and refilled with a quality antifreeze/water solution.

To check coolant level, visually inspect the coolant overflow recovery tank. DO NOT remove the radiator cap. With the engine idling and warmed to the normal temperature, the level of the coolant in the recovery tank should be between the two marks on the side. When additional



coolant is needed a minimum 50% concentration of ethylene glycol antifreeze in water should be added to the overflow recovery tank. A higher concentration (not to exceed 70%) should be used if a lower freeze point is required.

### **IMPORTANT**

Do not use additional rust inhibitors or anti-rust products, as they may not be compatible with the radiator coolant.

### **WARNING**

The radiator cap should be removed only when checking coolant freeze point or for complete replacement with antifreeze coolant. **DO NOT** remove radiator cap until the radiator has cooled completely. Use caution with hot coolant or steam. Place a cloth over the cap, turn left to first stop, pause to allow any pressure to release through overflow tube, then press down and turn left to remove cap.

### **CAUTION**

When refilling the coolant system of a vehicle with a rear auxiliary automotive heater and motoraid water heater, be sure to allow for the additional coolant capacity of heater and its supply and return hoses.

## **TIRES**

Properly cared for, the tires on your motor home should last for several thousand miles. One important factor that contributes to tire life is correct inflation pressure. Low air pressure not only results in tire overloading and abnormal wear, but also affects handling and fuel economy. The tire flexes more from the overload and builds up heat which weakens the tire, making it more susceptible to failure. Excessive air pressure causes the tire to wear abnormally in the center of the tread, produces a rough ride, and increases the chance of a tire failure from road hazards. After determining the weight of your motor home and the load on each tire by weighing the vehicle on scales, the proper inflation pressure can be obtained from the chart in this section.

### **WARNING**

Radial ply tires are optional on some motor home models. The tire option is not intended to upgrade the load rating of the entire vehicle and does not imply that GVWR and GAWR ratings can be increased over those figures found on the certification label or in the "specification" section of this manual.

Tire pressure should be checked at least monthly, preferably more often, especially during periods of frequent use. Inspect the tires often for any foreign objects caught in the tread which could work into the tire and cause tire failure. Always check tire inflation pressure when the tires are "cold", meaning the vehicle has not been driven for three hours or more, or driven less than one mile. It is normal for tire pressure to increase a few pounds when the tires become hot from driving. **DO NOT** reduce this pressure, as doing so reduces the "cold" pressure, resulting in under inflation.

Any excessive or abnormal wear may indicate worn or out of alignment suspension, excessive camber, incorrect toe, out of balance tire, or other tire or suspension problems. Have your dealer inspect the vehicle for the source of the problem and repair it immediately.

### **WARNING**

Make sure all replacement tires are of the same size and ply rating as those installed as original equipment. Do not install radial ply tires on wheels having diameters ranging from 16 to 19.5 inches that are not certified for radial tire application and do not have the word "radial" stamped on the wheel rim.

## **TIRE ROTATION**

To control certain types of tire wear which are caused by road crown, type of road or individual driving habits, the tires on your motor home should possibly be rotated. Refer to your tire manufacturers recommendations to determine whether or not you need to rotate your tires.

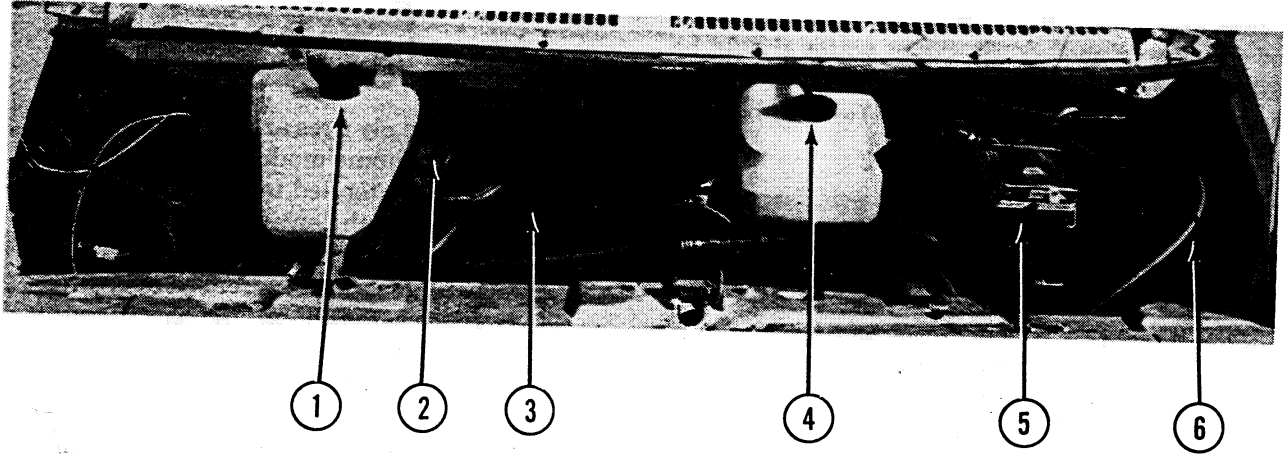

**ENGINE ACCESS**  
**C-Body Motor Home - Chevrolet Chassis**

1. Radiator Coolant Fill
2. Engine Oil Fill
3. Engine Oil Dipstick
4. Windshield Washer Fluid Fill
5. Brake Master Cylinder
6. Automotive Battery

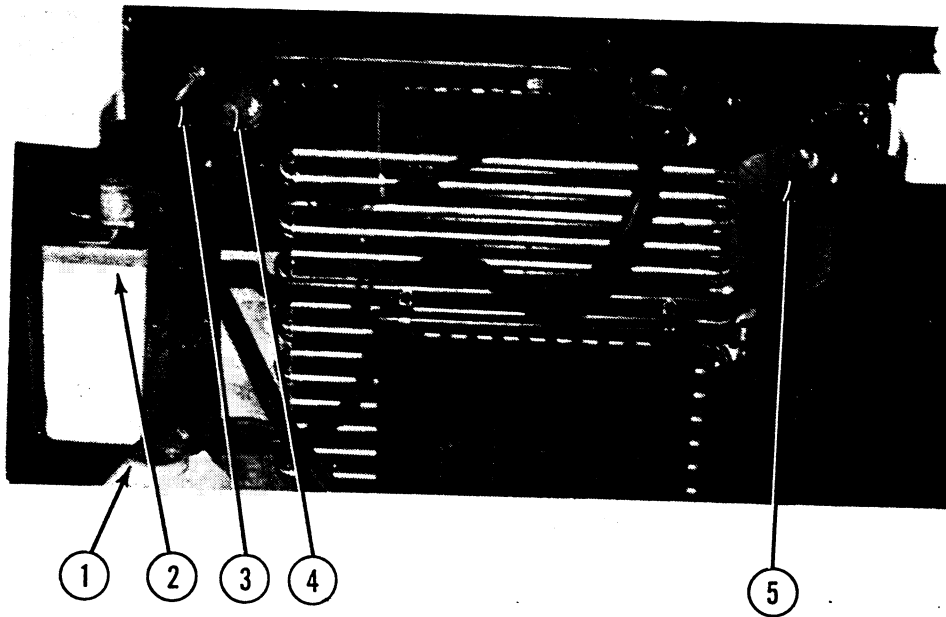

**ENGINE ACCESS**  
**A-Body Motor Home - Chevrolet Chassis**

1. Radiator Coolant Fill
2. Windshield Washer Fluid Fill
3. Engine Oil Dipstick
4. Engine Oil Fill
5. Power Steering Fluid Fill/Dipstick

**TIRE/WHEEL LOAD AND INFLATION PRESSURE**  
**TIRES USED AS SINGLES**  
**Tire Load Limits at Various Inflation Pressures**  
**(Chevrolet Chassis)**

Tire Size	Load Range	Max. Cap. (Lbs.)	Tire Load Capacity at Various Cold Inflation Pressures (Lbs. per square inch)									
			30	35	40	45	50	55	60	65	70	75
8.75-16.5	C	1990	1570	1720	1850	1990	---	---	---	---	---	---
8.75-16.5	D	2350	1570	1720	1850	1990	2110	2240	2350	---	---	---
8.75-16.5	E	2680	1570	1720	1850	1990	2110	2240	2350	2470	2570	2680
7.50-16.0	C	2060	1520	1770	1930	2060	---	---	---	---	---	---
7.50-16.0	D	2440	1620	1770	1930	2060	2190	2310	2440	---	---	---
7.50-16.0	E	2780	1620	1770	1930	2060	2190	2310	2440	2560	2670	2780
8.00-19.5	D	2800	---	---	---	---	2110	2270	2410	2540	2680	2800
8.00-16.5	D	2045	---	---	---	---	1840	1945	2045	2315	---	---
LT21585R16	D	2315	---	---	---	---	---	---	---	---	---	---

**IMPORTANT**

The indicated pressures are recommended for the tires originally supplied on the chassis. Many replacement market radial tires may require different pressures and the manufacturer's recommendations should be followed.

**IMPORTANT**

Always check tire type and ply or load range rating and follow the correct rotation diagram.

**TIRES USED AS DUALS**

Tire Size	Load Range	Max. Cap. (Lbs.)	Tire Load Capacity at Various Cold Inflation Pressures (Lbs. per square inch)									
			30	35	40	45	50	55	60	65	70	75
8.75-16.5	C	1750	1380	1380	1630	1750	---	---	---	---	---	---
8.75-16.5	D	2070	1380	1515	1630	1750	1855	1970	2070	---	---	---
8.75-16.5	E	2360	1380	1515	1630	1750	1855	1970	2070	2175	2260	2360
7.50-16.0	C	1815	1430	1565	1690	1815	---	---	---	---	---	---
7.50-16.0	D	2140	1430	1565	1690	1815	1930	2040	2140	---	---	---
8.00-19.5	D	2460	---	---	1850	1990	2110	2230	2350	2460	---	---
8.00-19.5	E	2680	---	---	1850	1990	2110	2230	2350	2460	2570	2680
8.00-16.5	D	1800	---	---	---	---	1620	1710	1800	---	---	---
LT215/85R16	D	2105	---	---	---	---	---	---	---	2105	---	---

## WINDSHIELD WASHERS AND WIPERS

During cold weather, at least half of the windshield washer solution in the reservoir must be antifreeze formulated for windshield washer use. Inspect the windshield wiper blades periodically for wear and replace when the wipers cause streaking on the windshield.

The windshield washer nozzles should be adjusted so the stream is directed to the upper part of the wiper pattern when the vehicle is not moving. If you require assistance, contact your dealer.

## LIGHTS

All exterior lights should be checked for proper operation each time the vehicle is prepared for a trip. Any bulbs which fail to light should be checked and replaced, when necessary, with a new bulb of the same size. A failure of more than one light, such as both taillights not operating, may indicate a burned-out fuse. Check fuse and replace with one of the same value when necessary. If the fuse is not the cause of the problem, have the wiring system checked immediately by the dealer.

The headlight circuit is protected by a circuit breaker. An overload on the breaker will cause the lights to flicker on and off. Have your headlight wiring checked immediately anytime this condition develops.

## FUSES

The automotive electrical circuits and accessories incorporated in your motor home are protected from short circuit conditions by a fuse panel. This panel is located beneath the dash to the left side of the steering column on C-body motor homes and beneath the radio on A-body motor homes.

Should any of the automotive electrical systems fail because of a blown fuse, replace the fuse at once with one of the same type and size (Amperage rating). Repeated blowing of a fuse may indicate a serious malfunction and should be checked by your Winnebago or Itasca dealer immediately.

### FUSE PANEL (Chevrolet Chassis)

- |                                   |        |
|-----------------------------------|--------|
| 1. Radio .....                    | 10 Amp |
| 2. Heater/Air Conditioner .....   | 25 Amp |
| 3. Stop Light and Hazard .....    | 15 Amp |
| 4. Windshield Wiper .....         | 25 Amp |
| 5. Directional Signal Flasher     |        |
| 6. Horn and Dimmer .....          | 15 Amp |
| 7. Instrument Lamps .....         | 5 Amp  |
| 8. Turn Signal and Back-Up Lights | 5 Amp  |

- |                            |        |
|----------------------------|--------|
| 9. Gauges .....            | 5 Amp  |
| 10. Tail Lights .....      | 20 Amp |
| 11. Hazard Warning Flasher |        |

## WARNING

Never replace a fuse with one of higher amperage rating than those specified.

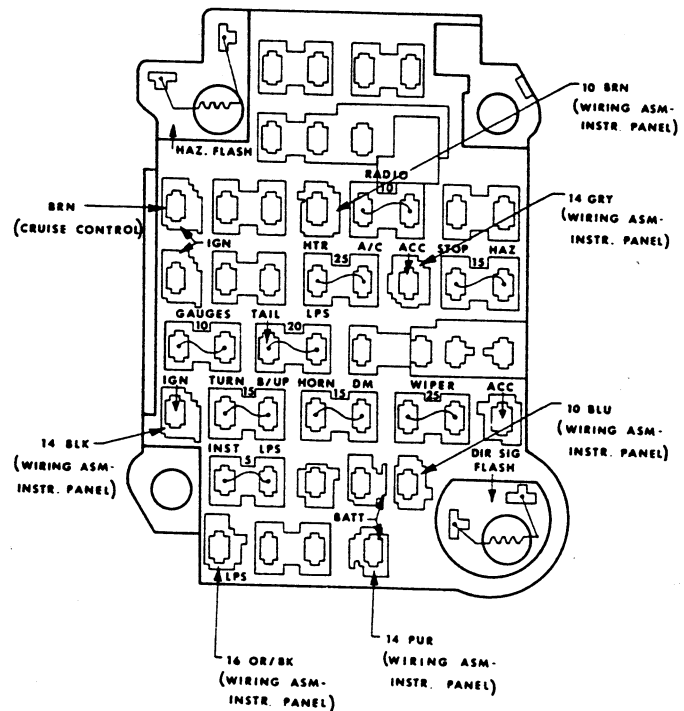

## MOTOR HOME JACKING AND TIRE CHANGE PROCEDURE (All Models with Chevrolet Chassis)

### IMPORTANT

The jack referred to in the following instructions is not furnished with the vehicle and must be obtained by the owner from a Chevrolet dealer or auto parts store.

The jack is designed for use as a tool for changing tires only, not for use as a leveling device or as a lift for service purposes.

## WARNING

The tire change procedure should be used in emergency situations only. The operator is advised to obtain qualified road service if at all possible.

Before attempting to change either the front or rear tires, the following precautions should be adhered to:

1. Jack the vehicle on a level surface only.
2. Turn off engine and set the parking brake. Activate hazard warning flasher.
3. Block both front and back of wheel opposite wheel to be removed.
4. On soft ground, use a board or other material under jack as a firm base to ensure that the jack will not shift.

### JACKING POINT ON VEHICLE

MODELS	FRONT	REAR
All	Lower Control Arm	Under Axle Housing Near Wheel to Be Raised

### Front Wheel

Before attempting to remove the front wheel, observe the above precautions and then initiate the following procedures:

1. Screw the jack extension out to approximately ground to spring height.
2. Slide jack under lower control arm.

NOTE: Lower control arm base must be cradled by the U-shaped saddle on the jack. Begin jacking until the jack is firmly positioned, but do not jack tire off the ground.

3. Loosen wheel nuts with stud wrench.
4. Resume jacking until wheel is free of ground. Operate jack from in front of vehicle.
5. Remove wheel nuts and wheel; put spare wheel in place.
6. Install wheel nuts and tighten as much as possible with wheel and tire off the ground.
7. Lower tire until tire just contacts the ground. Tighten nuts with stud wrench in recommended sequence.
8. Finish lowering jack, remove jack and blocks.

### WARNING

Upon satisfactory completion of emergency tire change, it is highly recommended that the wheel nuts be properly torqued and inspected by qualified service personnel as soon as possible.

### Dual Disc Rear Wheel

Before attempting to remove the rear wheel, the safety precautions in the beginning of the motor home jacking procedures and then initiate the following procedures.

1. Screw jack extension out to approximate ground axle housing tube height.
2. Place the jack under axle housing near wheel to be raised. Center the jack on the housing so that the vehicle will not slide off the jack. Place the jack far enough inboard on the axle housing so that when the handle is inserted, the jack may be operated from either in front or behind the tire without getting under the vehicle.
3. Start jacking, but DO NOT lift wheel and tire off the ground.
4. Loosen wheel nuts with stud wrench.
5. Resume jacking until wheel and tire are free of ground.

NOTE: Full torque must be applied to dual rear wheel nuts with both wheels off the ground.

### WARNING

DO NOT crawl under vehicle.

6. Remove wheel nuts and wheel. Put wheel in place.

### IMPORTANT

When installing the outboard wheel and tire assembly, rotate the wheel so that an outboard wheel cutout, without the tire valve, is opposite the inboard wheel tire valve.

7. Replace wheel nuts and torque in recommended sequence, as follows:

### Tightening Sequence

8 Stud

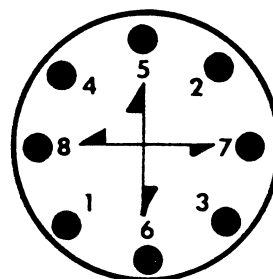

10 Stud

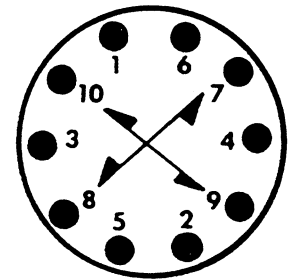

## IMPORTANT

The tires of both dual wheels must be completely off the ground when tightening to insure wheel centering and maximum wheel clamping.

- A. Tighten the wheel nuts in the numbered sequence to a snug fit.
- B. Retighten the wheel nuts in the same sequence to a torque of 140-180 foot-pounds. Repeat this procedure a second time to assure proper torque has been achieved.

### WARNING

Upon satisfactory completion of emergency tire change, it is highly recommended that the wheel nuts be properly torqued and inspected by qualified service personnel as soon as possible.

It is recommended that wheel stud nuts be kept torqued to specifications at all time. It is also recommended that they be checked after the first 100 miles (160 km) and then each time the engine oil is changed.

The outer wheel nut bears against the outer wheel only. If the inner wheel lock nut is not tightened to specifications, the mounting stud may loosen. With the outer stud nuts tightened, only the outer will be properly secured. The inner wheel may still be loose enough to move on the mounting stud, causing the stud holes in the inner wheel to wear.

## IMPORTANT

To prevent the inner wheel from loosening, the dual rear wheel should be tightened as indicated in the following procedure:

- A. Jack the rear axle until the tires of both dual wheels are completely off the ground.
- B. Loosen the large outer nuts until the outer wheel is loose.
- C. Tighten the small inner nuts to 140 to 180 foot-pounds torque. This tightens the inner wheel only.
- D. Tighten the large outer nuts to 140 to 180 foot-pounds torque. Both the inner and outer nuts must be tightened to within 140 to 180 foot-pounds range.

NOTE: To facilitate wheel removal, it is recommended that the inner nuts be tightened more tightly than the outer nuts so the inner nuts do not loosen when the outer nuts are removed.

8. Lower the jack. Remove jack and blocks.

### WARNING

The operator is advised to obtain road service whenever possible and attempt tire changing under emergency conditions only and with close adherence to the instructions. If it becomes necessary to change a wheel, that wheel should be checked, after being properly torqued and inspected by qualified service personnel, at 100 miles and every oil change thereafter.

## Wheel Nuts

To eliminate the possibility of the wheel studs becoming elongated, all wheel nuts should be tightened at frequent intervals. This is especially important during the first hundred miles of operation to allow the wheel nuts to become properly set.

All nuts should first be firmly seated against the wheel. Then the nuts should be tightened to recommended torque by always tightening the nut opposite to the previously tightened nut.

NOTE: When installing or tightening dual wheels, both wheels on the same side must be off the ground (not resting on the inner dual). This minimizes the possibility of loose wheels after correct mounting torque is applied.

### WARNING

Upon satisfactory completion of emergency tire change, it is highly recommended that the wheel nuts be properly torqued and inspected by qualified service personnel as soon as possible.

**RECOMMENDED TORQUE  
DISC WHEELS  
CHEVROLET CHASSIS**

SERIES	DESCRIPTION	TORQUE
Rear Dual Wheels	9/16" Bolts (8)	Power Torque 110-140 lb. ft. Hand Torque 140-180 lb. ft.
Rear Dual Wheels	5/8" Bolts (10)	Power Torque 130-180 lb. ft. Hand Torque 150-200 lb. ft.

**Towing Safety Precautions**

1. Remove any equipment that interferes with towing sling. Place padding (heavy cloth or carpeting) between bumper and sling to prevent marring the bumper finish.
2. Do not place tow hooks on front axle where they will damage brake lines.
3. Do not attach tow hooks to bumper or associated brackets, front brake strut, sway-bar, or shock absorbers.
4. Use a safety chain system that is completely independent of the primary lifting and towing assembly.
5. Secure any loose or protruding parts of damaged units before towing.
6. Stay out from under the motor home when it is suspended by the towing assembly unless the unit is adequately supported by safety stands.
7. Do not allow passengers to ride in a towed unit.
8. Be familiar with and observe all state and local towing regulations.

## INDEX

- |  |             |  |         |
|--|-------------|--|---------|
| AC System, 110 Volt .....                  | 51          | Checklist, Loading .....               | 38      |
| Adjustment, Automatic Brake .....          | 13          | Child Restraint System .....           | 35,36   |
| Air Cleaner Element, Dual Fuel Units ..... | 50          | Cigarette Lighter .....                | 18      |
| Air Conditioner                            |             | Circuit Breaker .....                  | 57      |
| Automotive .....                           | 16,17       | City Water Connection .....            | 68      |
| Roof .....                                 | 90-92       | Cleaning                               |         |
| Air Conditioner Selector Switch .....      | 92          | Carpet .....                           | 99,100  |
| Air in LP Gas Tank .....                   | 65          | Draperies .....                        | 100     |
| Alternator Indicator .....                 | 19          | Exterior .....                         | 99      |
| Ammeter Gauge .....                        | 19          | Upholstery .....                       | 99,100  |
| Antenna, Television .....                  | 92,93       | Work Surfaces .....                    | 100     |
| Automatic Brake Adjustment .....           | 13          | Clock .....                            | 18      |
| Automatic Ignition Furnace .....           | 73-75       | Cold Weather Starting,                 |         |
| Automatic Transmission .....               | 14,40       | Dual Fuel Units .....                  | 48,49   |
| Auxiliary Battery .....                    | 53-55       | Conditioner, Air                       |         |
| Auxiliary 110-Volt Generator .....         | 55-61       | Automotive .....                       | 16,17   |
| Hourmeter .....                            | 18,57       | Roof .....                             | 90-92   |
| Maintenance .....                          | 57-61       | Convertor, Power .....                 | 51-53   |
| Operating Cautions .....                   | 56,57       | Convertible Couch .....                | 98      |
| Operation .....                            | 56-60       | Converting Dinette to Bed .....        | 97      |
| Overload Circuit Breaker .....             | 57          | Cooling System                         |         |
| Preparation for Use .....                  | 56          | Care .....                             | 106,107 |
| Switch .....                               | 18,55       | Coolant Recommendation .....           | 20      |
| Auxiliary Rear Automotive Heater .....     | 89,107      | Overheating Caution .....              | 20      |
| Bathroom Care .....                        | 100,101     | Couch .....                            | 97,98   |
| Battery Access .....                       | 53,54       | Cruise Control .....                   | 11,12   |
| Battery Charger, Control Center .....      | 51-53       | DC, 12 Volt System .....               | 51      |
| Battery Condition Meter and Switch .....   | 17,18       | Defroster, Windshield .....            | 16,17   |
| Battery Fluid Level .....                  | 54          | Defrosting, Refrigerator .....         | 87      |
| Battery Isolator .....                     | 51,55       | Demand Water Pump .....                | 66-68   |
| Battery Maintenance .....                  | 54          | Dimmer Switch .....                    | 13,14   |
| Battery Switch, Dual .....                 | 20,51,55    | Dinette/Bed .....                      | 97      |
| Beds .....                                 | 97,98       | Door and Window Maintenance .....      | 101     |
| Body Maintenance Checklist .....           | 101,102     | Door Handle .....                      | 33      |
| Brake Adjustment, Automatic .....          | 13          | Door Lock .....                        | 33      |
| Brake Fluid Reservoir .....                | 106         | Draining Holding Tanks .....           | 69      |
| Brake Warning Light .....                  | 18          | Drainage System .....                  | 69-72   |
| Brakes                                     |             | Draperies .....                        | 100     |
| Master Cylinder Fluid .....                | 106         | Driver's Compartment Door Lock .....   | 33      |
| Parking Brake .....                        | 13          | Driver's Seat .....                    | 33,34   |
| Power .....                                | 12,13       | Driving Tips .....                     | 42-45   |
| Self-Adjusting .....                       | 13          | Dual Battery Switch .....              | 20,55   |
| Warning Light .....                        | 18          | Dual Fuel System .....                 | 46-50   |
| Breaker Switch Panel .....                 | 52          | Dump Valve .....                       | 69      |
| Bulbs .....                                | 110         | Dumping Holding Tanks .....            | 69      |
| Bulk Tank System, LP Gas .....             | 46,47,62,63 | Electrical System .....                | 51-61   |
| Bunk, Front Pull-Down .....                | 97          | Electronic Ignition Water Heater ..... | 89      |
| Bunk, Overhead Slider .....                | 97          | Emergency Equipment Checklist .....    | 38      |
| Bunk, Side Pull-Down .....                 | 97          | Emergency Starting .....               | 54,55   |
| Capacities .....                           | 7-9         | Emergency Exit .....                   | 38,39   |
| Carbon Monoxide Warning .....              | 37          | Emergency Exit Window .....            | 38,39   |
| Carpet Care .....                          | 99,100      | Use of Slider Windows as Exit .....    | 39      |
| Chassis Lubrication .....                  | 6           | Engine Access .....                    | 106     |
| Chassis Maintenance .....                  | 6           | A-Body .....                           | 106     |
| Checking Engine Oil .....                  | 50          | C-Body .....                           | 106     |



Engine Cooling System .....	106,107	Gas, LP .....	5,46,47,49,62-65
Engine Cover .....	106	Gasoline (See Fuel) .....	5,19,42
A-Body .....	106	Gear Selection .....	6
C-Body .....	106	Generator Circuit Breaker .....	57
Engine Oil .....	106	Generator Hourmeter .....	18,57
Dipstick .....	106	Generator, 110 Volt Auxiliary .....	55-61
Level, Checking .....	106	Generator Operation Cautions .....	56,57
Entrance Door Handle .....	33	Generator Service Schedule .....	61
Entrance Door Lock .....	33	Generator Storage Procedures .....	60,61
Equipment and Appliances .....	73-96	Generator Switch .....	18,56,57
Equipping for Travel .....	37,38	“Glow Plugs On” Indicator Light .....	20
Exits, Emergency .....	38,39	Gross Axle Weight Rating .....	4,6,39-40
Exterior Maintenance .....	99	Gross Vehicle Weight .....	4,6,49-40
External Power Connection .....	51	Gross Vehicle Weight Rating .....	4,6,39-40
External Utility Supply .....	51	Ground Fault Interrupter .....	53
External Water Connection .....	68	Hazard Warning Flasher .....	11
External Water Supply .....	68	Headlight	
Fabric Care .....	99,100	High Beam Dimmer Switch .....	13,14
Fabric Draperies Care .....	100	High Beam Indicator .....	13,14
Fresh Water Toilet .....	69-71	Switch .....	15
Filling Procedure		Heater and Air Conditioner Controls ....	16,17
Fuel Tank .....	42	High Beam Indicator Switch .....	13,14
LP Bulk Tank .....	46,47,62,63	Hitch, Trailer .....	7-9,40,41
Water Tank .....	67	Holding Tank .....	69,72
Fire Extinguisher .....	44	Hourmeter, Generator .....	18,57
Flashers		Ignition Keys .....	10
Hazard Warning .....	11,110	Ignition Switch .....	10
Turn Signal .....	10,11,110	Implied Warranties .....	2
Flash Flood and Severe Weather		Individual Model Specifications Charts ...	7-9
Safety .....	44,45	Inflation Pressure, Tire .....	109
Floor Controls .....	12-14	Instruments and Controls .....	10-14
Fluid Capacities .....	7-9	Instrument Panel .....	15-25
Fluid Level		Interior Furnishings .....	97,98
Batteries .....	6	Internal Water Supply .....	66,67
Brake Master Cylinder .....	6	Introduction .....	1-3
Engine Oil .....	6	Itasca Traveler’s Club .....	1
Power Steering .....	6	Jacking Procedures .....	110-113
Radiator .....	6,20,106,107	Jump Starting .....	54,55
Transmission .....	6	Keys .....	10
Fold-Up Table .....	98	Kitchen Facilities	
Formaldehyde Warning .....	5	Microwave Oven .....	77,78
Four Way Hazard Warning Flasher .....	11	Range and Oven .....	75-77
Front Pull Down Bunk .....	97	Range Hood and Vent .....	77
Fuel Economy Gauge .....	19,20	Refrigerator .....	78-87
Fuel Filter .....	49	Sink .....	100
Fuel Gauge .....	19	Kohler 110 Volt Generator .....	59-61
Fuel Requirements .....	6	Leak Detector .....	64
Fuel Tank Filling .....	42	Leveling Refrigerator .....	78
Fuel Tank Selector Switch .....	19	Lighter, Cigarette .....	18
Furnace, Gas		Lighting Instructions	
Lighting .....	73	Furnace .....	73
Maintenance .....	74,75	Oven Pilot .....	79
Troubleshooting .....	75	Refrigerator .....	79,83,85
Fuse Panel, Motor Home .....	51,52	Water Heater .....	88,89
Fuses, Automotive .....	110	Lights	
Gas Furnace .....	73-75	Brake Warning .....	18

Hazard Flasher	11
Headlight Circuit Breaker	14
Headlight Switch	15
High Beam Indicator	13,14
Turn Signal Indicator	10,11
Limited Warranty	1-3
Loading, Roof	40
Loading the Motor Home	39
"Low Coolant" Warning Light	20
LP Gas	5,62-65
Leak Detector	64
Procedures to Follow in Event of an LP	
Gas Leak	65
Regulator Freeze-Up	63,64
Supply	62
System	48,62-65
System Maintenance	49,50
Tank	46,62,63
Lubrication	104
Master Cylinder, Brake	106
Microwave Oven	77,78
Monitor Panels	93-96
Motor Aid (Water Heater)	89
Mountain Driving	45
New Season Preparation	104,105
New Vehicle Break-In	6
Night Time Diving	45
Non-Powered Range Hood and Vent	77
Odometer	18
Oil	
Checking Engine Oil Level	
(Motor Home)	106
Checking Engine Oil Level	
(Generators)	58,59
Filter (Motor Home)	49,50
Oil Viscosity (Motor Home)	6
Oil Viscosity (Generator)	61
Oil Pressure Gauge	18
Onan 110 Volt Generator	57,58,61
One Hundred Ten Volt AC System	51
Oven	75-77
Owner Relations, Contacting	3
Parking Brake	
A-Body	13
C-Body	13
Parking Lights	15
Pedestal Dinette Table	98
Pilot Ignition Water Heater	87-89
Pilot Lights	
Oven	76
Water Heater	88
Power Brakes	12,13
Power Control Center	51-53
Power Convertor	52
Power Cord	51,56
Power Steering	10

Pre-Travel Checklist	37
Procedures to Follow in the Event of an	
LP Gas Leak	65
Quick Loading Checklist	38
Radios	26-32
Range and Oven	75-77
Range and Refrigerator Care	76,87,100
Range Hood and Vent	77
Refilling Water Tank	66
Refilling Bulk LP Tank	46,47,62,63
Refrigerator	78-87
Refrigerator Troubleshooting	80-82,84
Removal From Storage	104,105
Roof Air Conditioner	90-92
Roof Loading	40
Roof Maintenance	99
Rotation, Tire	107
Safety Precautions	4-5
Sanitizing the Potable Water System	68
Seat	33,34
Adjustments	34
Belts	34,35
Seat and Door Panel Controls	33-36
Service Schedule - 110 Volt Generator	61
Shoulder Belts	35
Signals, Turn	10,11
Sink Care	100
Slide-Out Couch	97
Spark Arrestor, Generator Exhaust	56
Specifications	6-9
Speed Control	11,12
Speedometer	18
Square Back Bucket Seat Youth Bed	34
Stainless Steel Sink	100
Stains, Removal of	99,100
Starting the Engine	48
Steering	
Column Controls	10,11,15
Power	10
Tilt	10
Storage, Generator	60,61
Storage, Motor Home	49,103-105
Table	
Dinette	97
Pedestal	98
Pull-Out	98
Temperature Gauge	18,19
Thermostat, Furnace	73
Tilt Steering	10
Tips	
Travel	42,43
Winter Camping	43,44
Tires	
Inflation Pressure	109
Inspection	107
Load Limit	109

Rotation .....	107	Waste Distribution Chart .....	72
Tire Changing and Jacking		Water	
Procedures .....	110-113	External Connection .....	68
Toilet		Pump .....	66,67
Maintenance .....	70,71	Tanks .....	66,67
Operation .....	70,71	Water Heater .....	87-89
Troubleshooting .....	70,71	“Water in Fuel” Indicator Light .....	20,42
Trailer Towing .....	40,41	Water Pump .....	66,67
Transmission .....	14	Initial Start-Up .....	66
Braking on Hills with Transmission .....	45	Maintenance .....	66
Selector .....	14	Troubleshooting .....	67
Travel Tips .....	42,43	Water System .....	66-68
Travel with LP Gas .....	63	Drain Valve Locations .....	105
Turn Signals .....	10,11	External .....	68
TV Antenna .....	92,93	Internal .....	66,67
Twelve Volt DC System .....	51	Weighing the Motor Home .....	39,40
Underbody Maintenance .....	99	Weight Distribution .....	39,40
Upholstery and Carpeting Care .....	99,100	Windshield	
Use of In-Park Sewer System .....	69	Defrosting .....	16,17
Utility Systems		Washer .....	110
Drainage System .....	69-72	Wipers .....	110
Electrical System .....	51-61	Winnebago Traveler’s Club .....	1
LP Gas System .....	62-65	Winnebago Limited Warranty .....	1-3
Water System .....	66-68	Winter Camping Tips .....	43,44,65
Vacuum Cleaner .....	90	Winterizing .....	103,104
Vacuum Gauge .....	19,20	Work Surface Care .....	100
Warranty .....	1-3	Woven Wood Draperies .....	100
Washer, Windshield .....	15,16		



# NOTICE OF SECOND OWNER

ORIGINAL OWNER	NAME		
	ADDRESS		
NEW OWNER	NAME		
	ADDRESS		
VEHICLE IDENTIFICATION NO.		VEHICLE MILEAGE	DATE
ORIGINAL OWNER SIGNATURE		NEW OWNER SIGNATURE	

**IMPORTANT:** THIS NOTICE IS TO USED ONLY FOR RECORD KEEPING BY WINNEBAGO INDUSTRIES.  
The completed form does not constitute an actual change of ownership.



# IMPORTANT SERIAL NUMBERS

You will want to make a record of all serial numbers for future reference.  
Look for them and fill in immediately.

Motor Home Serial Number \_\_\_\_\_

Chassis Serial Number \_\_\_\_\_

Air Conditioner Serial Number \_\_\_\_\_

Range Model and Serial Number \_\_\_\_\_

Refrigerator Model and Serial Number \_\_\_\_\_

Furnace Model and Serial Number \_\_\_\_\_

Water Heater Model and Serial Number \_\_\_\_\_

Converter Model and Serial Number \_\_\_\_\_

Optional 110-Volt Generator Model and Serial Number \_\_\_\_\_

When writing to the factory be sure to include your motor home serial number and chassis number.  
When writing to a component manufacturer for information, be sure to include the model and serial number for the item.

## EMERGENCY INFORMATION

### DEALER

Name \_\_\_\_\_

Address \_\_\_\_\_

\_\_\_\_\_

Phone \_\_\_\_\_

### INSURANCE POLICY

Company \_\_\_\_\_

Policy Number \_\_\_\_\_

Phone \_\_\_\_\_

**by Winnebago Industries, Inc.  
Forest City, Iowa 50436**

**054185-20-000**

