

Congratulations! We welcome you to the exciting world of motor home travel and camping. You will find it convenient and enjoyable to have all the comforts of home and still enjoy the great outdoors wherever you choose to go.

Your motor home has been carefully designed, engineered and manufactured to provide dependability as well as safety. Before sliding into the driver's seat, take a few minutes to become familiar with operations and features. This manual was prepared to aid you in the proper care and operation of the vehicle and equipment. We urge you to read it completely. In addition, spend some time with the dealer when you take delivery, you will want to learn all you can about your new motor home.

Your new motor home is covered by a factory warranty against defects in material and workmanship. This warranty should be validated at once and returned to the factory by your dealer.

Read and understand all instructions and precautions in this manual before operating your new motor home.

Throughout this manual, certain items are labeled NOTE, CAUTION and WARNING. These terms alert you to precautions that can involve risk to your vehicle or to your personal safety. Read and follow them carefully.

NOTE: Indicates a special point of information.

CAUTION

Indicates that a failure to observe can cause damage to vehicle or equipment

WARNING

This symbol is used to alert you to precautions that involve your personal safety as well as vehicle damage. Read and follow them carefully.

OWNER'S NAME
STREET ADDRESS
CITY AND STATE (OR PROVINCE IN CANADA)
MOTOR HOME SERIAL NUMBER
VEHICLE CHASSIS IDENTIFICATION NO. (VIN)
DATE OF DELIVERY TO FIRST RETAIL PURCHASER
VEHICLE MILEAGE AT TIME OF DELIVERY
SELLING DEALER NAME AND ADDRESS

TANK CAPACITIES



Chassis Fuel Tank

Ford Chassis w/6.8L EFI Gas Engine 55 gal.
 Ford Chassis w/7.3L Navistar Diesel Engine 55 gal.



LP Gas Tank

All Models 14.4 gal.* (18 gal. w.c.)



Fresh Water Tank

Model 427P 40 gal.
 Model 429U 31 gal.
 Models 430V & 431C..... 35 gal.



Water Heater - All Models 6 gal.



HT1 - Black Water Holding Tank

Model 427P (Toilet, Lavatory & Galley) 38 gal.
 Model 429U (Toilet & Lavatory) 34 gal.
 Model 430V (Toilet & Lavatory) 35 gal.
 Model 431C (Toilet & Lavatory)..... 35 gal.



HT2 - Gray Water Holding Tank

Model 427P (Shower) 35 gal.
 Model 429U (Galley & Shower) 31 gal.
 Model 430V (Galley & Shower) 38 gal.
 Model 431C (Galley & Shower)..... 38 gal.

*LP Gas tank capacity shown is the usable “full” LP gas capacity, which is 80% of the tank manufacturer’s listed water capacity (w.c. shown in parenthesis). An LP tank must have at least 20% of tank volume free to allow for expansion and proper vaporization of the liquid fuel. The tank is also equipped with mandatory safety shut-off equipment that prevents filling above this level.

INTRODUCTION

About This Manual	0-1
Chassis Operator's Guide	0-1
Owner's InfoCase	0-1
Options and Equipment	0-2
Before Driving	0-2
Service Assistance	0-2
Warranty	0-2
Drinking and Driving	0-2
Reporting Safety Defects	0-2
Vehicle Certification Label	0-4
Exterior Feature Identification	0-5

SECTION 1: SAFETY PRECAUTIONS

General Warnings	1-1
Driving	1-1
Fuel & LP Gas	1-2
LP Gas Leaks	1-2
LP Gas Alarm	1-3
Electrical	1-4
Loading	1-4
Maintenance	1-4
Formaldehyde Warning	1-5
Carbon Monoxide Warning	1-5
Carbon Monoxide Alarm	1-5
Emergency Exit Window	1-6
Fire Extinguisher	1-7
Smoke Alarm	1-7

SECTION 2: DRIVING YOUR MOTOR HOME

Before Entering	2-1
Before Driving	2-1
Keys	2-2
Fuel Selection	2-2
Gasoline Fuel Fill	2-2
Fuel Tank Capacity	2-2
Starting and Stopping Engine	2-3
Fuel Pump Shutoff Switch	2-3
Parking Brake	2-3
Hazard Warning Lights	2-3
Door Locks and Handles	2-3
Entrance Step	2-4
Seats	2-5
Lounge Chairs	2-7

Seat Belts	2-7
Child Restraints	2-8
Mirrors	2-9
Instrument Panel	2-10
Comfort Controls	2-11
Heating	2-11
Air Conditioning	2-11
Rear Auto Heater	2-11
Radio/Cassette Player	2-11
Auxiliary Start Switch	2-11
Auxiliary Battery Switch	2-11
Slideout Room	2-12 - 216

SECTION 3: IN CASE OF DRIVING

EMERGENCY

Hazard Flashers	3-1
Spare Tire	3-1
Tire Changing	
Safety Precautions	3-1
Wheel Nuts	3-2
Recovery Towing	3-2
Jump Starting	3-2
Connecting Jumper Cable	3-3
Connecting a Battery Charger	3-3
Engine Overheat	3-3

SECTION 4: TRAVELING WITH YOUR MOTOR HOME

Loading the Vehicle	4-1
Roof Loading	4-2
Car or Trailer Towing	4-2
Pre-Travel Checklist	4-3
Travel Tips	4-4
Severe Weather Information	4-4
Nighttime Driving	4-5
Mountain Driving	4-5
Campsite Selection	4-6
Blocking	4-6
Effects of Prolonged Occupancy	4-7
Humidity and Condensation	4-7

SECTION 5: LP GAS SYSTEM

LP Gas Supply	5-1
Safe Use of LP Gas System	5-1
How LP Gas Works	5-1

TABLE OF CONTENTS

Selecting Fuel Types	5-2	SECTION 8: APPLIANCES AND	
LP Tank System	5-2	INTERIOR FEATURES	
Refilling Tank	5-3	Refrigerator	8-1
Air in the LP Gas Tank	5-3	Range and Oven.....	8-4
Traveling with LP Gas	5-3	Microwave Oven.....	8-5
Regulator.....	5-3	Range Hood	8-5
LP Gas Leaks	5-4	Monitor Panel	8-6
Winter Use of LP Gas	5-5	Water Heater, Gas	8-7
		Motor Aid Water Heater	8-10
SECTION 6: ELECTRICAL SYSTEMS		By-Pass Valve	8-10
110-Volt AC System	6-1	LP Gas Furnace.....	8-11
External Power Cord (Shoreline).....	6-1	Heat Pump	8-11
Power Center.....	6-2	Ducted Roof Air Conditioner	8-12
Converter	6-2	TV Antenna.....	8-14
Thermal Breaker	6-3	TV Signal Amplifier	8-15
110-Volt Circuit Breakers	6-3	Cable TV Hook-Up	8-15
110-Volt Receptacles (Outlets)	6-3	Video Selector System	8-15
Ground Fault Circuit Interrupter (GFCI).....	6-3	Digital Satellite Television System.....	8-16
Auxiliary 110-Volt Generator		DC-AC Voltage Inverter	8-16
Operating Instructions.....	6-4, 6-5	Exterior Entertainment Center	8-17
12-Volt DC System	6-6	Sleeping Facilities	
Automotive (Starting) Battery	6-6	Overhead Bunk	8-17
House Battery	6-6	Couch-Bed Conversion.....	8-17
12-Volt Fuses	6-6	Dinette/Bed Conversion.....	8-18
Chassis Battery Access (Storage)	6-7	Fresh Water Toilet.....	8-18
Battery Maintenance	6-7	Power Roof Vent	8-19
Trailer Wiring Connector	6-9	Slider Windows.....	8-19
		Pleated Shades	8-19
SECTION 7: PLUMBING SYSTEMS		SECTION 9: CARE AND MAINTENANCE	
Fresh Water System	7-1	Sealants	9-1
Filling Water Tank	7-1	Roof	9-1
Fresh Water Tank Capacity	7-1	Underbody	9-1
Water Pump.....	7-1	Exterior	9-1
Water Pump Switch.....	7-1	Waxing and Polishing	9-1
Disinfection of Water Tank	7-2	Stripes and Decals, care of.....	9-2
External (City Water) Connector	7-2	Interior Maintenance	
Shower Valve Pressure Bleed-Off	7-3	Upholstery, Carpeting and	
Exterior Shower	7-3	Draperies	9-2
Drainage System (Waste).....	7-3	Cabinets	9-3
Dumping Holding Tanks.....	7-4	Vinyl Wallboard	9-3
Using On-Site Sewer Hook-Ups.....	7-4	Tables and Countertops.....	9-3
Water Drain Valves	7-4	Stainless Steel Sink	9-3
Winterization Valve.....	7-5	Bathroom	9-3
Holding Tank Capacities.....	7-6	Doors and Windows.....	9-3
Water System Drain Valve		Window Roll-Up Shade Adjustment	9-4
Locations.....	7-7 - 7-8	Vehicle Maintenance	
		Chassis Service and Maintenance.....	9-4

Engine Access.....	9-4
Engine Cooling System	9-4
Tires	9-4
Suspension Alignment and Tire Balance.....	9-4
Ride-Rite Helper Springs.....	9-5
Windshield Washers and Wipers.....	9-5
Lights	9-5
Automotive 12-Volt Circuit Breakers	9-5

SECTION 10: STORING YOUR MOTOR HOME

Preparing Vehicle for Storage	10-1
Cold Weather Storage (Winterizing).....	10-1 - 10-3
Remove from Storage	10-3



Congratulations on the purchase of your new Winnebago Minnie Winnie motor home, which has been carefully designed, engineered and quality built by Winnebago Industries, Inc.



ABOUT THIS MANUAL

Please read this operator's manual completely to understand how everything in your coach works before taking it on its "maiden voyage."

This manual is a guide to safe operation of the features, equipment and controls in this coach. Some equipment, such as the vehicle chassis and certain electronic systems or appliances, have their own comprehensive, manufacturer supplied manuals or information sheets which describe operation of these products in great detail. This manual will refer you to the manufacturer's information included in your Owner *INFOCASE* whenever necessary.

SUBJECT ICONS - To make it easier for you to find information you're looking for, we have placed convenient, pictorial symbols called "icons" beside many of the subject headings in this manual. The icons correspond to the subject matter of the section. These icons were designed similar to the familiar international symbols which identify public facilities such as restrooms and handicap access. There are several examples of icons on this page.

PAGE ICONS - The icons at the upper corners of each page correspond to the primary content of each main section of the manual, such as LP Gas, Electrical, Plumbing, etc. This means you can flip through the manual either forward or backward and know exactly which main section you are looking for just by watching the icons at the top of the page. This means less paging back and forth.

We also urge you to read the complete Chassis Operating Guide provided by the chassis maker and all other operating information provided by our equipment suppliers and manufacturers. This is contained in your Owner *INFOCASE*TM.

This manual should be kept in the vehicle at all times for personal reference. The operator's manual, *INFOCASE* and chassis operating guide are to be considered permanent components of this vehicle. They should remain in the vehicle when sold to provide the next owner with important safety, operating and maintenance information.

NOTE: The descriptions, illustrations, and specifications in this manual were correct at the time of printing. We reserve the right to change specifications or design without notice, and without incurring obligation to install the same on products previously manufactured.



CHASSIS OPERATING GUIDE

Throughout this manual, frequent reference is made to the vehicle chassis operating guide. The chassis guide is the operator's manual provided by the manufacturer of the chassis on which this motor home is built (i.e., Chevrolet or Ford). Consult the chassis guide for operating safety and maintenance instructions pertaining to the chassis section of the motor home.



OWNER'S INFOCASE

Your Owner's InfoCase contains information supplied by manufacturers of individual appliances and equipment installed in your motor home.

Consult this information regarding the operation and care of appliances, accessories and special equipment.



OPTIONS AND EQUIPMENT

This model is available in several sizes and floorplans, so accessories and components may differ slightly between models. Some equipment described in this manual may not apply to your coach.



BEFORE DRIVING

Before sitting in the driver's seat, always check around your vehicle to be sure you have proper clearance for maneuvering. If necessary, have a passenger help guide you out of a difficult parking space.

Although your coach features automotive conveniences like power steering and power brakes, driving a motor home is different from driving a car. A motor home is larger and heavier than an automobile, so it requires more stopping and passing distance, and more parking and maneuvering space than does a car.

Always be aware of the size of your motor home. The added height of roof air conditioners, TV antennas or luggage boxes may cause clearance problems around some tunnels, canopies and hanging signs. Know the height of your unit so you can observe posted clearance limits. Also, remember that some bridges, old ones in particular, may not support the weight of your motor home. Know the weight of your unit and observe any posted weight limits.

Remember: Always use your seat belt and be sure your passengers do so as well. We also advise making frequent rest stops while traveling to relieve stress on yourself, your passengers and your vehicle.

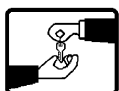

SERVICE AND ASSISTANCE

Your dealer will be glad to provide any additional information you need, as well as answer any questions you might have about operating the equipment in your motor home. When it comes to service, remember that your dealer knows your vehicle best and is interested in your satisfaction.

Your dealer will provide quality maintenance and any other assistance that you may require during your ownership of this vehicle.

If you need warranty repairs while traveling, however you may take your motor home to any Winnebago or Itasca dealership and they will assist you.



WARRANTY

Your new vehicle is covered by a factory warranty against defects in material and workmanship. This warranty should be validated immediately and returned to the factory by your dealer. For additional information, see your "New Vehicle Limited Warranty" included with this vehicle.



DRINKING AND DRIVING

Winnebago Industries supports the recommendations of the Presidential Commission on Drunk Driving.

- Exercise your good judgment and encourage others to do the same.
- Know the legal limits and do not exceed them.
- Also know your personal limits, which may be lower than the legal limits.
- Should you ever exceed your limits, find alternative transportation; call a cab, ask a friend to drive you home or call a family member to come and get you.

The presence of alcohol in significant levels in the blood increases the probability that the driver will be involved in an accident.

REPORTING SAFETY DEFECTS

If you believe that your vehicle has a defect which could cause a crash or could cause injury or death, you should immediately inform the Na-



tional Highway Traffic Safety Administration (NHTSA) in addition to notifying Winnebago Industries, Inc.

If NHTSA receives similar complaints, it may open an investigation, and if it finds that a safety defect exists in a group of vehicles, it may order a recall and remedy campaign. However, NHTSA cannot become involved in individual problems between you, your dealer, or Winnebago Industries.

To contact NHTSA, you may either call the Auto Safety Hotline toll-free at 1-800-424-9393 (or 366-0123 in Washington, D.C. area) or write to: NHTSA, U.S. Department of Transportation, Washington, D.C. 20590. You can also obtain other information about motor vehicle safety from the Hotline.



VEHICLE CERTIFICATION LABEL

This label contains vehicle identification and other important reference information. The vehicle certification label is located on the sidewall to the left of the steering wheel, or on the driver's door. Never remove or destroy this label.

MANUFACTURED BY 		INCOMPLETE VEHICLE MANUFACTURED BY ① MOTOR CORP.	
③ GAWR:		MONTH AND YEAR OF MANUFACTURE: ② GVWR ④ LB _____ KG	
FRT _____ LB _____ KG RR. ⑤ LB _____ KG	SUITABLE TIRE AND RIM CHOICE TIRE _____ RIM _____	COLD INFLATION PRESSURE PSI _____ KPA SINGLE ⑧ PSI _____ KPA ⑨	
THIS VEHICLE CONFORMS TO ALL APPLICABLE FEDERAL MOTOR VEHICLE SAFETY STANDARDS IN EFFECT ON THE DATE OF MANUFACTURE SHOWN ABOVE.			
SERIAL NO. ⑩ TYPE _____ ⑫		VIN _____ ⑪ MODEL _____ ⑬ COLOR _____ ⑭	

EXPLANATION OF DATA

1. Chassis manufacturer.
2. Chassis manufacture date.
3. Month and year of manufacture at Winnebago Industries.
4. Gross Vehicle Weight Rating: Total permissible weight of the vehicle, including driver, passengers, total cargo carried (including all liquids) and equipped with all options.
5. Gross Axle Weight Rating: Total permissible weight allowed for the front, intermediate* and rear axles (listed in pounds and kilograms).
6. Suitable Tire Choice: Tires recommended to meet handling and safety requirements. When replacing any of the tires on your vehicle, always replace with a tire that meets these specifications.
7. Suitable Rim Choice: Wheel rims recommended to meet handling and safety requirements. When replacing any of the rims on your vehicle, always replace with a rim that meets these specifications.
8. Cold Inflation Pressure: Inflation pressures recommended (while Cold) for the tires originally equipped on your vehicle. These pressure levels must be maintained to assure proper handling, safety and fuel economy.
9. Rear Axle Wheel Configuration: Single or Dual.
10. Serial Number: This is the serial number assigned to the completed vehicle by Winnebago Industries.
11. Vehicle Identification Number (VIN): This number identifies the chassis on which the motor home is built. The 10th digit of the VIN designates the chassis model year. (Y=2000, 1=2001). This information is useful when ordering chassis repair parts.
12. Type: States the NHTSA designated usage classification for your motor home. MPV signifies a Multi-purpose Passenger Vehicle.
13. Model: Lists the Winnebago product model number of your vehicle.
14. Color: Signifies the color code number of the decor used throughout the vehicle. This number is necessary for ordering replacement cushions, curtains, carpet, etc.



EXTERIOR FEATURE IDENTIFICATION - Class C Motor Homes
 Typical model shown for illustration purposes only.
 Actual locations of features depends on your model and option combinations

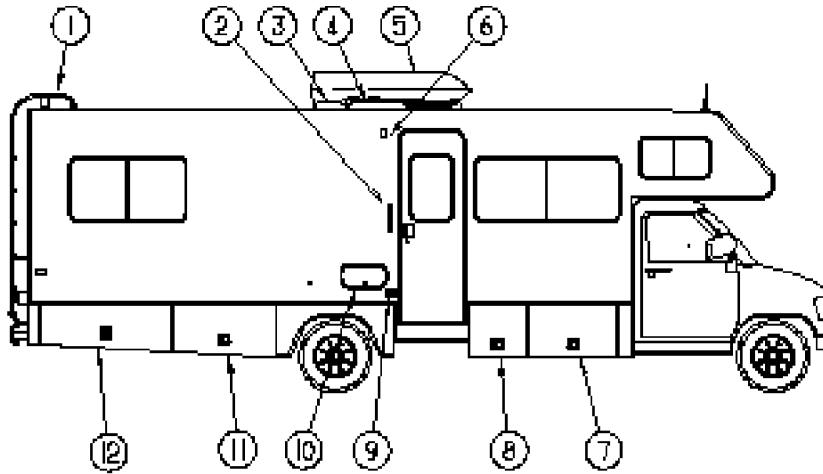

- | | |
|-------------------------|-------------------------------|
| 1. Roof Access Ladder | 7. LP Gas Tank Access |
| 2. Assist Handle | 8. Storage Compartment |
| 3. TV Antenna | 9. 110-Volt Outlet |
| 4. Refrigerator Vent | 10. Ext. Entertainment Center |
| 5. Roof Air Conditioner | 11. Storage Compartment |
| 6. Porch Light | 12. Storage Compartment |

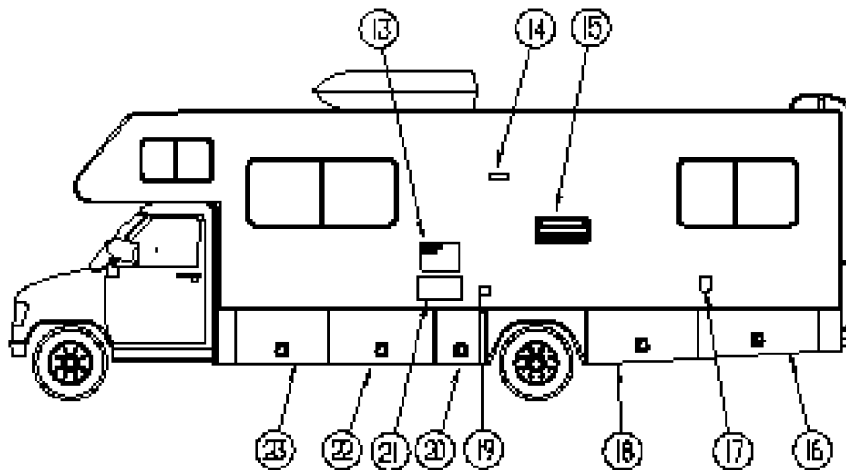

- | | |
|-------------------------------------|----------------------------|
| 13. Water Heater Access† | 19. Fuel Tank Fill |
| 14. Range Hood Vent | 20. Storage Compartment |
| 15. Refrigerator Service Access | 21. Furnace Intake Exhaust |
| 16. Auxiliary Generator Compartment | 22. Storage Compartment |
| 17. Water Tank Fill | 23. Storage Compartment |
| 18. Utility Systems Compartment | |

NOTE: Some equipment shown may be optional.

**Also cable TV hook-up on some models

†CAUTION: Be careful. These features may become HOT while water heater or furnace are in use



Read and understand all instructions and precautions in this manual before operating your new motor home. Throughout this manual, certain items are labeled NOTE, CAUTION and WARNING. These terms alert you to precautions that can involve risk to your vehicle or to your personal safety. Read and follow them carefully.

NOTE: Indicate special points of information.

CAUTION

Indicates that a failure to observe can cause damage to vehicle or equipment

WARNING

This symbol is used to alert you to precautions that involve your personal safety as well as vehicle damage. Read and follow them carefully.

Listed below are some safety precautions that must be adhered to. These precautions as well as others that involve damage to equipment are also listed in the appropriate areas in this manual.



GENERAL WARNINGS

- Only seats equipped with seat belts are to be occupied while the vehicle is moving.
- Make sure all passengers have seat belts fastened in a low and snug position so the force exerted by the belt in a collision will be spread across the strong hip area. Pregnant women should wear a lap-shoulder belt whenever possible, with the lap belt portion worn low and snug throughout the pregnancy.
- All seats which can be positioned, such as swiveling, sliding, reclining, or footrest out, must be placed in a fully upright and swivel-

locked position with footrests retracted while the vehicle is moving. Some swivel lounge chairs are designed to lock in a forward facing position, while others lock in an aisle facing position. Be certain these seats are secure from swiveling before traveling.

- Never let passengers stand or kneel on seats while the vehicle is moving.
- Sleeping facilities are not to be utilized while vehicle is moving.
- Examine the escape window and be familiar with its operation, but do not use except in an emergency.
- Inspect the fire extinguisher monthly for proper charge and operating condition. This should also be done before beginning a vacation or any extended trip.



DRIVING

- Do not attempt to adjust the driver's seat while the vehicle is moving.
- Do not adjust tilt steering in a moving vehicle.
- Do not operate the cruise control on icy or extremely wet roads, winding roads, in heavy traffic, or in any other traffic situation where a constant speed cannot be maintained.
- Use care when accelerating or decelerating on a slippery surface. Abrupt speed changes can cause skidding and loss of control.
- Driving through water deep enough to wet the brakes may affect stopping distance or cause the vehicle to pull to one side. Check brake operation in a safe area to be sure they have not been affected. Never operate any



SECTION 1 SAFETY PRECAUTIONS

Minnie Winnie

vehicle if a difference in braking efficiency is noticeable.

- Adverse weather conditions and extremes in terrain may affect handling and/or performance of your vehicle. Refer to your chassis manual for related information.



FUEL & LP GAS



- All pilot lights must be extinguished and appliances turned off while refilling the fuel tank or LP tank.
- Never smoke while refilling vehicle fuel tank or LP gas tank.
- Avoid inhaling exhaust gases produced by burned gasoline, diesel fuel or LP gas in items such as the range, chassis engine, generator engine, refrigerator, furnace and water heater. They contain carbon monoxide, which is an odorless, colorless and poisonous gas.
- Do not bring or store LP gas containers, gasoline or other flammable liquids inside the vehicle because a fire or explosion may result. LP gas containers are equipped with safety valves which relieve excessive pressure by discharging gas to the atmosphere.
- Do not fill LP gas container(s) above 80 percent of capacity. Overfilling the LP gas container can result in uncontrolled gas flow which can cause fire or explosion. A properly filled container will contain approximately 80 percent of its volume as liquid LP gas.
- Never use an open flame to test for LP gas leaks. Replace all protective covers and caps on LP system after filling. Make sure valve is closed and door latched securely.
- Never connect natural gas to the LP gas system.
- When lighting range burners do not turn burner controls to "On" and allow gas to escape before lighting match.
- Portable fuel-burning equipment, including wood and charcoal grills and stoves, shall not be used inside the recreational vehicle. The use of this equipment inside the recreational vehicle may cause fires or asphyxiation.
- LP gas regulators must always be installed with the diaphragm vent facing downward. Regulators are equipped with a protective cover. Make sure that the regulator vent faces downward and that the cover is kept in place to minimize vent blockage which could result in excessive gas pressure causing fire or explosion.
- The following warning label is located in the cooking area to remind you to provide an adequate supply of fresh air for combustion.



Unlike large homes, the oxygen supply inside a recreational vehicle is limited due to its size. To avoid danger of asphyxiation, provide proper ventilation when using the gas rangetop or gas oven. It is especially important that the gas oven and range top not be used for comfort heating. Danger of asphyxiation is greater when these appliances are used for long periods of time.



LP GAS LEAKS

The following label is located in the vehicle near the range area. If you smell gas within the vehicle, quickly and carefully perform the procedures listed.



IF YOU SMELL GAS

1. Extinguish any open flames, pilot lights and all smoking materials.
2. Do not touch electrical switches.
3. Shut off the gas supply at the tank valve(s) or gas supply connection.
4. Open doors and other ventilating openings.
5. Leave the area until odor clears.
6. Have the gas system checked and leakage source corrected before using again.



LP GAS ALARM

Your coach is equipped with an LP gas detector which sounds an alarm if an unsafe amount of LP gas is present inside the coach. Because LP gas is heavier than air, the detector is located on a cabinet face near the floor of the coach.

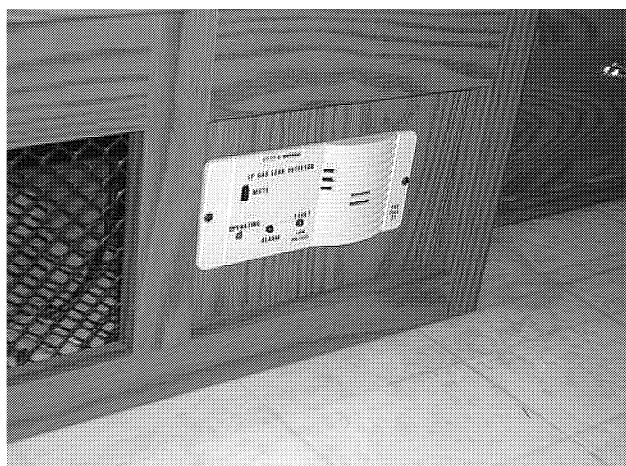

A green light on the face of the alarm shows when the unit is active. If the detector senses LP gas, the alarm will make a loud, pulsating sound and the red light will come on. Pressing the "MUTE" button will stop the alarm for 60 seconds. If there is no more detectable LP gas, the alarm will stay off. If the detector still senses LP gas by the end of the 60 second mute mode, the alarm will sound again.

Press to stop alarm

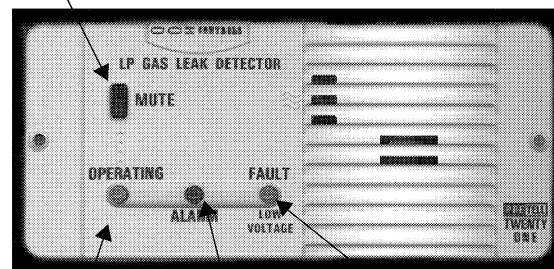

Green
(Active)

Red
(Alarm)

Amber
(Low Batt.)

If The Alarm Sounds

If the alarm sounds, do not touch any electrical switches. Immediately turn off the main LP tank valve and all LP appliances, open all windows and roof vents, and leave the coach until the alarm stops sounding.

If the alarm keeps sounding at regular intervals, a leak may be present. Contact your dealer or an LP gas service center to have the problem corrected before using the LP system again.

If the coach batteries become extremely drained (8.5 volts or less), the amber Low Voltage/FAULT light on the face of the alarm will come on, and in some rare cases the LP alarm may begin to sound on its own. This condition is not likely to occur except during storage situations when coach battery charge is not being restored by the inverter charger or solar charger.

Other Combustible Fumes or Vapors

This alarm is designed to detect the presence of LP gas, however there are other combustible fumes or vapors which may be detected by the sensor. These include: alcohol, liquor, deodorants, colognes, perfumes, wine, adhesives, lacquer, kerosene, gasoline, glues, most all cleaning agents and the propellants of aerosol cans. Most are lighter than air in their vapor state and will only be detected when the area is closed up. Glues and adhesives may exhaust hydrocarbon vapors for months after they are applied. They are easily activated by high temperatures. If you close up an RV coach on a hot day, the chemicals used in its construction may be detected for months after the coach was manufactured.



SECTION 1 SAFETY PRECAUTIONS

Minnie Winnie

Further Information

See the manufacturer's information supplied in your Owner InfoCase for further descriptions and directions including monthly testing and troubleshooting.

WARNING

Never use an open flame to test for gas leaks. When testing for gas line leaks with a soapy water solution, DO NOT use a detergent containing ammonia or chlorine. These substances may generate a chemical reaction causing corrosion to gas lines, resulting in dangerous leak conditions.

Power Connection

The gas alarm is powered by the coach batteries. If the battery cable is disconnected from the batteries, auxiliary battery switch is shut off, or the circuit breaker is tripped, the alarm will not work. The LP gas alarm breaker is located on the power converter breaker panel shown on page 6-6.

Because the LP gas alarm is connected directly to the auxiliary battery, it is always drawing a small amount of current. Even though this current draw is slight, it could drain the coach battery during storage periods of 30 days or longer. We recommend turning the auxiliary battery switch off or disconnecting the battery cables from the auxiliary battery during extended storage periods to avoid discharge.

Further Information

See the manufacturer's information entitled "Your LP Gas Detector" in the Owner InfoCase for further instructions on nuisance alarms and care and testing of the LP gas detector.



ELECTRICAL

- Careless handling of electrical components can be fatal. Never touch or use electrical components or appliances while feet are bare, while hands are wet, or while standing in

water or on wet ground.

- Improper grounding of the vehicle can cause personal injury. Do not plug the utility power cord into an outlet which is not grounded and do not adapt the plug to connect to a receptacle for which it is not designed.
- Do not attach an extension cord to the utility power cord.
- Be sure that all electrical appliances to be used contain 3-prong plugs for proper grounding.
- Avoid overloading electrical circuits. Replace fuses or circuit breakers with those of the same size and amperage rating only. Never use a higher rated fuse or breaker.
- Use caution when handling or working near electrical storage batteries. Always remove jewelry and wear protective clothing and eye covering. Avoid creating sparks.

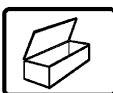

LOADING

- Store or secure all loose items inside the motor home before traveling.
- Be aware of GVWR, GAWR and individual load limit on each tire or set of duals. (See "Loading the Vehicle" in Section 4.)
- Never load the motor home in excess of the gross vehicle weight rating or the gross axle weight rating for either axle.



MAINTENANCE

- Do not remove the radiator cap while engine and radiator are still hot. Always check coolant level visually at the see-through coolant reservoir.



- Never get beneath a vehicle that is held up by a jack only.
- Do not mix different construction types of tires on the vehicle such as radial, bias or belted tires, as vehicle handling may be affected. Replace tires with exact size, type and load range.
- Do not attempt to start the vehicle by hot wiring.

FORMALDEHYDE INFORMATION

WARNING

Some components in this vehicle contain formaldehyde based adhesives which may release formaldehyde fumes into the air for an unknown period of time until total dissipation occurs. Individuals who are allergic to formaldehyde gas fumes may experience irritation to eyes, ears, nose and throat. Reaction in infants may be more severe. Although long range effects are not well understood, testing to date has not revealed any serious health effects in humans at the level of emission from these products.

NOTE: To aid in dissipation, ventilate the vehicle by opening all windows and circulating the air with a fan.

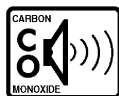

CARBON MONOXIDE WARNING

WARNING

Avoid inhaling exhaust gases, as they contain carbon monoxide, which is a colorless, odorless and poisonous gas.

If you suspect that exhaust fumes are entering the passenger compartment, have the cause deter-

mined and corrected as soon as possible. If you must drive under these conditions, drive only with ALL WINDOWS FULLY OPENED.

The best protection against carbon monoxide entry into the vehicle body is a properly maintained engine exhaust and ventilation system. It is recommended that the exhaust system and body be inspected by a qualified motor home service center.

- Each time the vehicle is raised for an oil change.
- Whenever a change in the sound of the exhaust system is noticed.
- Whenever the exhaust system, underbody or rear of the vehicle is damaged.

To allow proper operation of the vehicle's ventilation system, keep front ventilation inlet grill clear of snow, leaves or other obstructions at all times. **DO NOT OCCUPY A PARKED VEHICLE WITH ENGINE RUNNING FOR AN EXTENDED PERIOD.**

Do not run engine in confined areas, such as a garage, except to move vehicle in or out of area. When vehicle is stopped in an UNCONFINED area with the engine running for any more than a short period, adjust heating or cooling system to force outside air into the vehicle as follows:

1. Set fan to medium or high speed and vent control to air.
2. On vehicles equipped with air conditioning, set fan to medium or high speed and set control to obtain maximum vent air.

Rear windows should be closed while driving to avoid drawing dangerous exhaust gases into the vehicle.

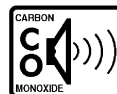

CARBON MONOXIDE ALARM

Your coach is equipped with a carbon monoxide (CO) alarm, located on the ceiling in the bedroom area.



SECTION 1 SAFETY PRECAUTIONS

Minnie Winnie

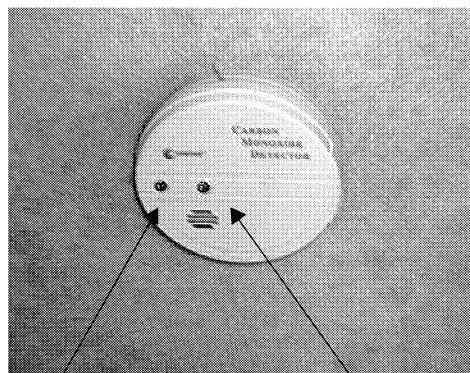

Red Light
(Press to Test Alarm)

Yellow Light
(Warning)

The CO alarm is powered by a 9-volt battery and contains a sensor that is designed to detect toxic carbon monoxide gas fumes resulting from incomplete combustion of fuel. It will detect CO gas from any combustion source such as the furnace, gas range/oven, water heater, refrigerator, chassis engine, and electric generator engine.

- Patented biomimetic sensor mimics the human response to Carbon Monoxide.
- Test/Reset alarm circuitry, microprocessor, battery and horn.
- Red light flashes once every thirty seconds in normal operation.
- Continuous yellow light with a beep every three seconds indicates an unhealthy CO level.
- Continuous red light and pulsating alarm signal a dangerous CO condition.
- Battery operation provides protection 100% of the time. Low battery signal alerts consumer of need to replace battery.
- 85 decibel alarm assures waking during sleeping hours.

Monthly Testing

Press the TEST button on the face of the alarm periodically (at least monthly) to check the function of the alarm and condition of the battery. If the alarm begins to beep every few seconds, the battery may be weak and need replacement. (Press the TEST button to be sure before replacing the battery.) If the alarm sounds, the battery may still be okay. If the alarm still beeps every few seconds, check the smoke detector also. The “low battery” warning beep is similar on many

alarm devices, so the origin of this electronic sound can be deceiving.)

Further Information

Please read the manufacturer’s guide included in your Owner InfoCase. It includes information on precautions, operational testing, and battery/sensor replacement.



EMERGENCY EXITS Emergency Exit Windows

Your motor home is equipped with an emergency exit window in the rear of the vehicle that functions as an escape exit in an emergency situation.

Side Escape Window

The side mounted escape window is secured by two red safety latches and can be opened by first releasing these two latches and then pushing outward on the lower part of the window. Identify which type of emergency exit window is in your vehicle.

Instructions for removal are also located near the latches for quick reference and for passengers who may not be familiar with the exit. Never remove or destroy this label.

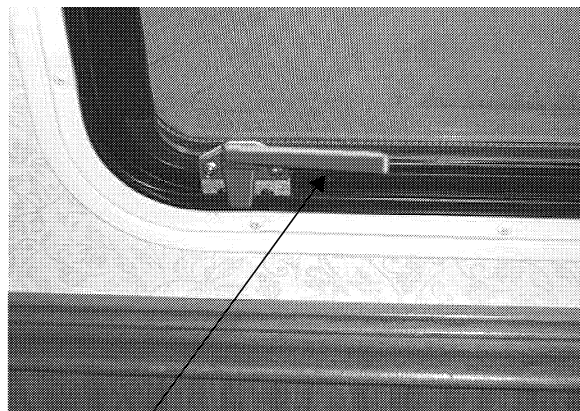

Lift Both Handles Up
Push Out on Bottom of Window

Rear Escape Window

To open, pull on the red plastic loop at the bottom of the window until the rubber cord is completely removed. This allows the window to be pushed out.



Instructions for removal are also located on a label on the glass for quick reference and for passengers who may not be familiar with the exit. Be sure this label is never removed or destroyed.

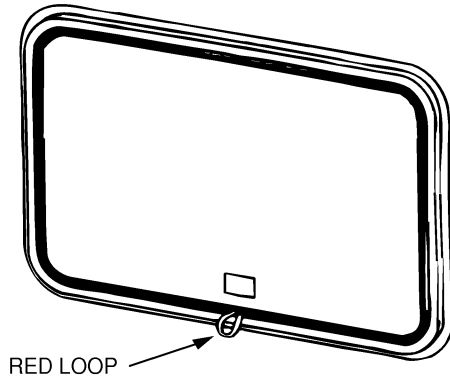

WARNING
Use emergency window for emergency exit only. Do not test for proper operation.

If the cord is released by accident, but the glass remains in place, the cord can be replaced using a blunt instrument, preferably one made of plastic. We suggest you contact your dealer for assistance.

WARNING
Use care when exiting emergency window, as broken glass may be present in the exit area.

USING SLIDER WINDOWS AS EMERGENCY EXITS

Most slider windows along the side of the motor home can also be used as emergency exits, should the need arise. To use the windows as exits, first slide the window open, then slide the screen open.



FIRE EXTINGUISHER

A dry chemical fire extinguisher is located near the floor by the side entrance door.



We recommend that you become thoroughly familiar with the operating instructions displayed on the side of the fire extinguisher or in the information supplied in your Owner InfoCase.

We also recommend that you inspect the fire extinguisher for proper charge at least once a month in accordance with National Fire Protection Association (NFPA) recommendations as stated on the label. If the charge is insufficient, the fire extinguisher must be replaced.

WARNING
Do not test the fire extinguisher by discharging it. Partial discharge can cause leakage of pressure or contents which would render the unit inoperative when needed. When using the fire extinguisher, aim the spray at the base of the fire.



SMOKE ALARM

Your motor home is equipped with a smoke alarm located on the ceiling in the galley area. This alarm meets U.L. Standard 217 and NFPA Standard 74 for operation of smoke detection devices.

1. The smoke alarm should be tested for correct operation each time the vehicle is brought out of storage, before each trip, and at least once a week during motor home use. To test the electronics, firmly depress the button. To



SECTION 1 SAFETY PRECAUTIONS

Minnie Winnie

test that smoke reaches the sensor, blow smoke in a careful, fire-safe manner into your smoke alarm.

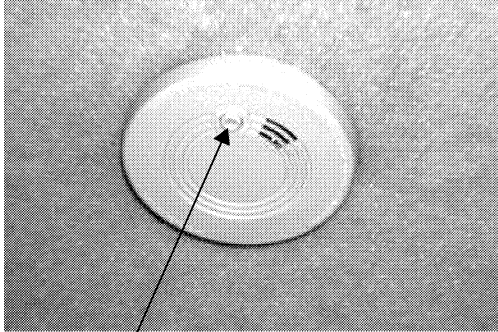

Press Button
to Test

2. Your smoke alarm will not work without power. Never remove the battery to quiet the alarm. When your smoke alarm “beeps” about once a minute the battery is weak. Install a new battery immediately. Be sure to use only batteries specified in manual or on unit. Test unit after installing a new battery.
3. Clean and vacuum the openings on your smoke alarm once a month.
4. Do not open the smoke alarm or try to repair it. For replacement information see warranty in Owner’s Manual.
5. Smoke alarms have technical limitations and may not respond in all situations. FIRE PREVENTION is your best safeguard.

See your Owner InfoCase for further information.



(See also Safety Precautions, Section 1 of this manual.)

NOTE: See your Ford Owner's Guide for information on starting the engine, operating the transmission, steering column controls descriptions of instrument gauges and other chassis related information.

Some items described in this section may be optional or unavailable on your coach.

7. Unhook and store sewer and water supply hoses.
8. Retract step.
9. Be sure that all of your cargo is secured in event of a sudden stop or an accident.
10. Check around your vehicle in all directions to assure that you have proper clearance.
11. Lower TV antenna.
12. Disconnect and store shoreline.

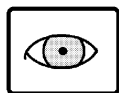

BEFORE ENTERING YOUR VEHICLE

Before entering your vehicle, there are a few recommended procedures that will aid in your driving safety and equipment.

1. Be sure that the windows, mirrors and light lenses are clean and unobstructed.
2. Make sure all exterior lights operate properly.
3. Check tires for proper cold inflation pressures and inspect for any unusual wear.
4. Check wheel lug nuts for tightness.
5. Look beneath the vehicle for noticeable fluid leakage.
6. Check fluid levels and fill if necessary. This includes engine oil, transmission fluid, coolant, brake fluid, power steering fluid and windshield washer solvent.

WARNING

The transmission must be in P (Park) and park brake engaged while performing any checks or adjustments.

The engine should be shut off unless specifically required for a certain procedure.

WARNING

Before driving your vehicle, be sure you have read the entire operator's manual and that you understand your vehicle's equipment completely and how to use the equipment safely.



BEFORE DRIVING YOUR VEHICLE

Before preparing to drive your vehicle, here are a few recommended procedures that will add to your driving safety and enjoyment.

1. Be sure that you adjust the interior and exterior rear view mirrors to your driving preference.
2. Adjust the driver's seat for proper distance from foot pedals and steering wheel to allow for safety and ease in controlling your vehicle.
3. Place front seats in the forward facing position.
4. Be sure to fasten all safety belts to fit you comfortably, but tight enough to obtain the full safety of the belts.
5. Make sure all doors are completely shut and locked. When the doors are shut and locked, there is less chance of the doors flying open in event of an accident. It also prevents unintentional opening of doors and keeps intruders out of your vehicle.



6. Check to see that all gauges are operating properly.
7. Check the fuel level in the vehicle.
8. Be certain that the fire extinguisher is fully charged and secure in its mounting bracket.

CAUTION

Be sure hood and all compartment doors are latched securely before driving vehicle.

KEYS

Your motor home is supplied with several sets of keys. In addition to the chassis manufacturer's ignition key, you receive keys for front doors, entrance door, and exterior compartment doors.

Each set of keys has an identification number, either a small metal tag or stamped into the key head. Record these numbers and keep them in a safe place. In case keys are lost or stolen, your dealer or a locksmith can provide you with duplicate keys or modify the locks.

NOTE: Keys should always be removed when leaving the vehicle. Since doors can be locked without keys, make sure they have been removed from the ignition before locking the driver's compartment.



FUEL SELECTION

Refer to your chassis operating guide for the manufacturer's recommendations on proper fuel selection.

WARNING

Modern fuel systems may build up pressure within the tank as the gasoline warms during use or in hot weather.

Under certain conditions, sudden release of this pressure when removing the gasoline cap can spray gasoline from the fuel fill opening, causing a possible hazard.

GASOLINE FUEL FILL

REMOVING THE FUEL CAP

When removing the gasoline cap, slowly rotate it **only far enough to allow pressure to release**. After any "hissing" sounds stop, continue removing the cap.

FILLING THE TANK

Do not overfill the fuel tank. Allow gasoline to pump into the tank until the auto-shutoff valve in the fuel pump nozzle stops the flow of fuel, indicating a full tank. This provides a pre-determined vapor space at the top of the tank to allow for expansion of the gasoline.

CAUTION

Continuing to fill above this level may cause damage to the fuel/evaporative emission system.



Chassis Fuel Tank Capacity

Ford Chassis w/6.8L EFI Gas Engine	.55 gal.
Ford Chassis w/7.3L Navistar Diesel Engine55 gal.

REPLACEMENT FUEL CAPS

To protect gasoline system from excessive pressure or vacuum, or from sudden pressure, replace lost caps with caps of the same design available from your dealer.

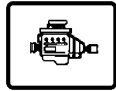

STARTING AND STOPPING ENGINE

Refer to your chassis operating guide for the manufacturer's recommendations on starting and stopping the engine.

Brake-Shift Interlock

Ford chassis are equipped with a brake-shift interlock safety feature. The shift lever cannot be moved from the Park position unless the ignition is ON and the service brake pedal is pressed.

NOTE: On Ford chassis, if the brake light fuse is blown, the interlock feature will not work properly and an alternate method must be used. See your Ford Owners Guide for detailed instructions on what to do in this situation.

FUEL PUMP SHUT-OFF SWITCH

Vehicles built on Ford chassis are equipped with an inertial type switch that shuts off the fuel pump in the event of collision. This switch must be manually reset to resume the fuel supply to the engine.

See your Ford Owners Guide for location and reset procedures for this switch.

NOTE: It is possible to accidentally trigger the fuel pump shut-off switch by abruptly striking an object such as a curb or parking block. If your vehicle exhibits symptoms of running out of fuel immediately after such an occurrence, the fuel pump shut-off switch may need to be reset. Consult your Ford chassis operating guide for additional information.

PARKING BRAKE

Never drive your vehicle with the parking brake set. This will reduce parking brake effectiveness and cause excessive wear. Consult your chassis operating guide in your Owner InfoCase for operating instructions.



HAZARD WARNING LIGHTS

See chassis operating guide for location of hazard flasher switch. See also Section 3 for further operating information.

DOOR LOCKS AND HANDLES

NOTE: Keys should always be removed when leaving the vehicle. Since doors can be locked without keys, make sure they have been removed from the ignition before locking the driver's compartment.

The entrance door may be opened from outside the vehicle by pulling the door handle outward. To open the door from inside, pull outward on the door handle. When the door is locked, neither the inside nor the outside door handle can be operated.



ENTRANCE DOOR LOCK AND HANDLE

The entrance door may be opened from outside the vehicle by pulling the door handle outward. To open the door from inside, pull outward on the door handle. When the door is locked, neither the inside nor the outside door handle can be operated. It can be locked and unlocked from the outside of the vehicle by inserting the key into the lock and turning.

Deadbolt Lock

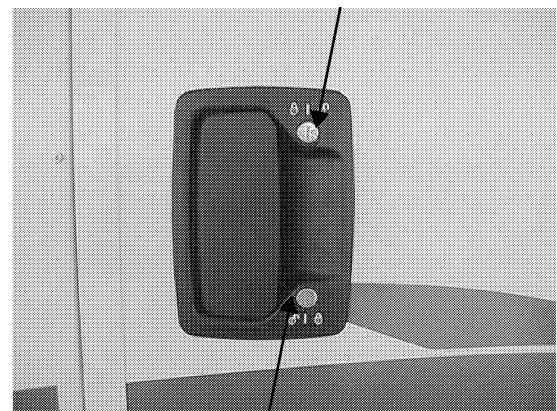

Door Lock



To lock the door from inside, rotate the lock levers as indicated. The deadbolt lock is for added security and should be used as a security night lock.

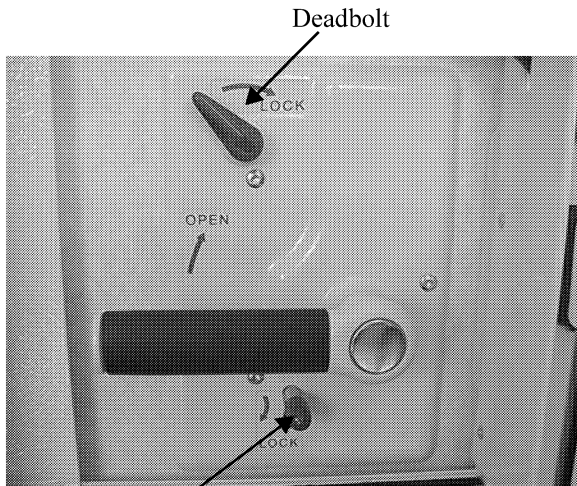

Door Lock
Entrance Door Handle - Inside

Press lever to separate screen door from main entrance door

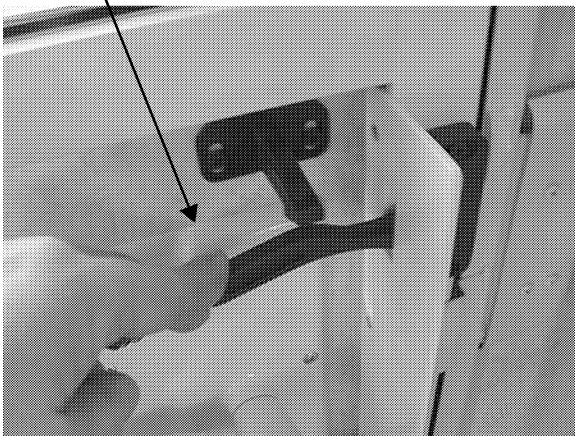

Screen Door Latch

Lubricate the locks periodically with graphite to maintain good working condition.

CAUTION

When releasing security night lock, be sure to retract bolt before opening door latch to prevent drag on bolt pin. Instruct all passengers in operation of this door catch system as well as emergency exit window.

DRIVER COMPARTMENT DOOR LOCK

Consult your chassis operating guide.



ELECTRIC ENTRANCE STEP

The power switch for the electric entrance step is located to the left of the main entry door as you enter the coach.

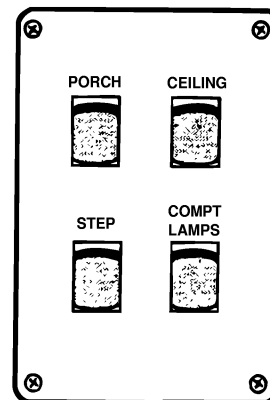

Entry Switch Panel



Automatic Mode (Operates with Door)

With the Power Switch in the On position the step is in Automatic Mode. This means it will extend and retract automatically whenever the door is opened or closed. This is done by means of a magnetic door switch attached to the lower hinged edge of the screen door section of the entrance doors. The steps will extend when the screen door is opened, and retract when the screen door is closed. With the power switch in the Off position the step can be kept in the extended or retracted position as described below.

Stationary Extended Mode

To keep the step in the extended position:

- turn the Power Switch to **On**,
- **open** the screen door to extend the step,
- then turn the Power Switch to **Off**.

The step will now stay extended whether the door is opened or closed. This position is normally used when parked at a campsite or whenever people are going to be entering and exiting the vehicle frequently.

Stationary Retracted Mode

To keep the step in the retracted position:

- turn the Power Switch to **On**,
- **close** the screen door to extend the step,
- then turn the Power Switch to **Off**.

The step will now stay retracted when the screen door is open or closed. This position is normally used where an exterior step is not required or to avoid damage to the step, such as when parked near a high curb or similar object.

Automatic Retraction Feature

The coach is equipped with a step retraction feature that retracts the step automatically when the Ignition Switch key is turned to either the On or Start position regardless of whether the Step Power Switch is On or Off. This feature is standard and is installed to prevent injury or damage which may be caused by an extended step when the vehicle is moving. An associated feature is the "Last Out Feature". This feature extends the step when the screen door is opened after the ignition switch has been turned to either the On or Start position.

WARNING

Do not use steps unless it is fully extended.

Do Not Stand on step when vehicles ignition switch is turned to either the "On" or "Start" position. The step will automatically retract, which may cause personal injury. Always remember to retract the step before moving the vehicle.

For additional information on the step, see the step manufacturer's operators manual included in your Owners *InfoCase*.



SEATS

The driver and co-pilot seats may be independently adjusted to suit individual preference. To move the seat forward or backward, lift the slide release paddle, located on the side of the seat, and exert slight body pressure in the direction desired.

To recline the seats: Lift the reclining lever, lean back to desired incline and release the lever. To return to the upright position, lift the lever and lean body forward. Allow the seat to return to the desired position and release the lever.



Seat Recline Levber

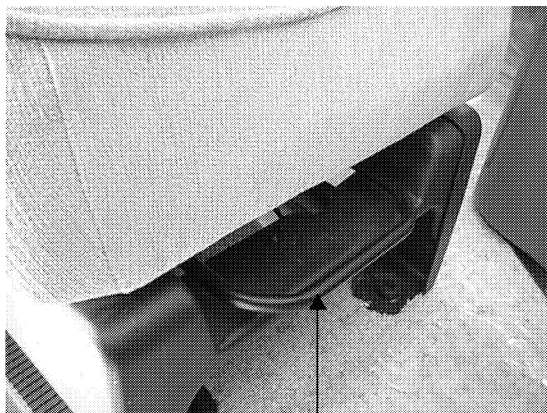

Seat Position Adjustment Bar
(Lift to slide forward - back)

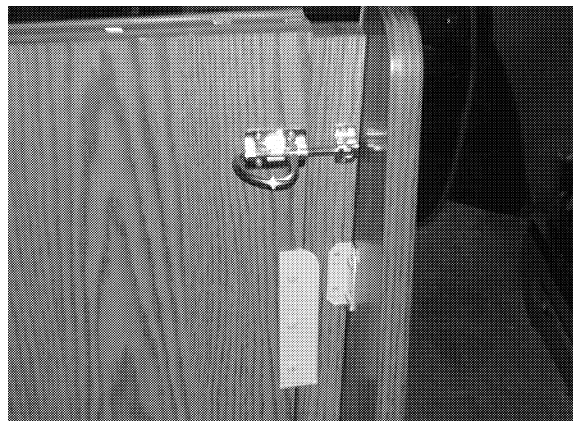

Dinette Seatback Latch
(Remove cushion and unbolt to fold down)

To slide seat front-back: Lift the seat adjustment bar and use body pressure to adjust the forward-rearward position of the driver seat. Release the bar to lock seat in desired position.

WARNING

Do not adjust driver's seat while vehicle is in motion.

After adjusting seat, always use body pressure to make sure slide and swivel locking mechanism have engaged.



Dinette seat fold down to allow front seat reclining.

If your model has a dinette seat located directly behind the driver or passenger front seat, the dinette seat back is hinged and can be folded down to allow full use of the front seat reclining feature. Simply remove the seat back cushion and unlatch the bolt latches on both sides of the dinette seat as shown, then fold downward.

ARM REST ADJUSTMENT

The driver and co-pilot seat armrests may be adjusted to rest at two different positions as shown.

Position 1 (Normal) - This is the normal "default" position of the armrest, which is generally used when the seat is in the upright position. If the armrest has been lowered to position 2 and you want it in normal position 1, raise the armrest until it pops outward slightly, then lower into normal position.

Position 2 (Lowered) - Raise the armrest straight up, then push the spring-loaded base of the armrest firmly inward against the seat. When you feel the armrest move inward, lower it into position



while still pushing the base inward against the seat. This position would generally be used when the seat is reclined.

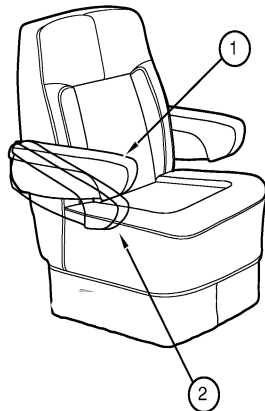

LOUNGE CHAIRS

The lounge chair has swivel and slider features to allow you to position the seat to your liking.

The swivel feature will lock in the center facing position for your safety while the vehicle is moving.

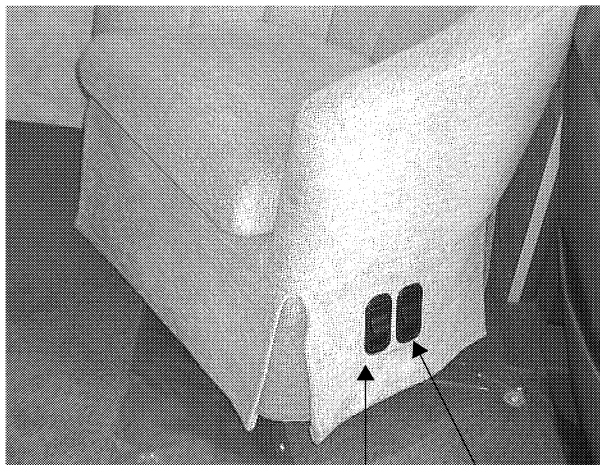

Lift to
Swivel

Lift to
Slide

To Swivel the seat: Pull up on the swivel lever located on the side of the seat. The seat will lock into place whenever it reaches the center aisle facing position.

Always return the seat to the aisle facing position for proper use of seat belts while traveling.

To Slide the seat: Pull up on the slide lever located on the side of the seat. Slide to desired position and release lever.

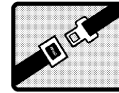

SEAT BELTS

Seats intended for occupancy while the vehicle is in motion are equipped with seat belts for the protection of the driver and passengers.

Lap Belts

The lap belts must be worn as low as possible and fit snugly across the hip area. Always sit erect and well back into the seat. To gain full protection of the safety belt, never let more than one person use the same safety belt at any one time, and do not let the safety belts become damaged by pinching them in the doors or in the seat mechanism. After any serious accident, any seat belts which were in use at the time should be replaced.

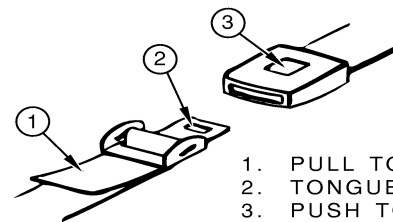

1. PULL TO TIGHTEN.
2. TONGUE.
3. PUSH TO RELEASE.

Adjustment: To lengthen belt, turn tongue at a right angle to belt and pull to desired length. To shorten, pull loose end of belt.

To Fasten: Be sure belt is not twisted. Grasp each part of the belt assembly and push tongue into buckle. Adjust to a snug fit by pulling the loose end away from the tongue.

To Release: Press button in center of buckle and slide tongue out of buckle.



WARNING

To reduce the risk of an injury in an accident, position the lap belt tightly and as low as possible across the pelvic area. Pregnant woman should be especially certain to wear the lap belt as low as possible across the pelvic area so there is no pressure on the abdomen.

Only seats equipped with seat belts are to be occupied while vehicle is in motion.

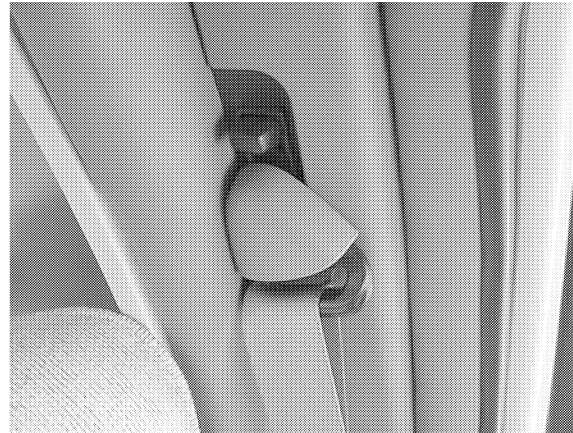

Lap-Shoulder Belts

Fastening: Hold the belt just behind the tongue using the hand nearest to the door. Next, bring the belt across the body and slide the tongue into the buckle until the latch engages.

Unfastening: Press the release button in the buckle. Hold onto the tongue when you release it from the buckle to keep it from retracting too rapidly.

When the lap-shoulder belt is in use, the lap portion must ride across the strong hip area and the shoulder portion must ride diagonally over the shoulder blade toward the buckle.

The shoulder belt is designed to lock only during a sudden stop, sudden body movement or a collision. At all other times it will move freely with the occupant.

WARNING

Never wear the shoulder belt in any position other than as stated above. Failure to do so could increase the chance or extent of injury in a collision

NOTE: On some models, the shoulder belt height can be adjusted to provide the most comfortable position for each individual person's size. To adjust shoulder belt height, press the lever down, select the desired position and release the lever. A ratcheting mechanism will allow the belt to be pushed upward but not pulled downward.

Seat Belt Care and Cleaning

- Be careful not to damage the belt webbing and hardware. Take care not to pinch them in the seat or doors.
- Inspect the belts and hardware periodically. Check for cuts, frays, and loose parts. Damaged parts should be replaced. Do not remove or modify the belt system.
- Keep belts clean and dry. If the belts need cleaning, use only a mild soap and water solution. Do not use hot water. Do not use abrasive cleaners or bleach. These products may weaken or damage the belts.
- Replace any belt assembly that was used during a severe impact. Replace the complete assembly even if damage is not apparent.



CHILD RESTRAINTS

All 50 of the United States and the District of Columbia now require the use of the child/infant restraint systems for children in vehicles.

A properly installed and secured child restraint system can help reduce the chance or severity of personal injury to a child in an accident or during a sudden maneuver. Children may be injured in an accident if they are not seated in a child restraint which is not properly secured.

A child restraint system is designed to be secured in a vehicle seat by a lap belt or the lap belt portion of a lap-shoulder belt. According to acci-



dent statistics, children are also safer when properly restrained in rear seating positions than in front seating positions.

When purchasing a child restraint system:

1. Look for the label certifying that it meets all applicable U.S. Federal Motor Vehicle Safety Standards (FMVSS) or, in Canada, requirements of the Children's Car Seats and Harnesses Regulations (CCSHR).
2. Make sure that it will attach to your vehicle and restrain your child securely and conveniently so that you are able to install it correctly each time it is used.
3. Be certain that it is appropriate for the child's height, weight and development. The instructions and/or the regulation label attached to the restraint typically provides this information.
4. Review the instructions for installation and use of the restraint. Be sure that you understand them fully and can install the restraint properly and safely in your vehicle.



INSTRUMENT PANEL GAUGES AND CONTROLS

The illustrations on the following page showing switches and features provided by Winnebago.

See your chassis owner's manual for detailed information on the instrument gauges, steering column controls, brakes, and other chassis original equipment.



MIRRORS

Always adjust mirrors for maximum rear visibility before driving off. Make sure the seat is adjusted for proper vehicle control and that you are sitting back squarely into the seat.

Tilt the surface of the mirror gently up or down, left or right, to obtain the best rear view.

Side Mirror Head Adjustment

While sitting properly in the driver seat and the mirror arms extended normally, have a helper grip the mirror head by opposite upper and lower corners and move it horizontally and vertically for proper rearward vision.

NOTE: For power mirrors, be sure the power adjustment is in the middle of its adjustable range, both up-down and right-left, before adjusting the head position.



INSTRUMENT PANEL (Ford Chassis)

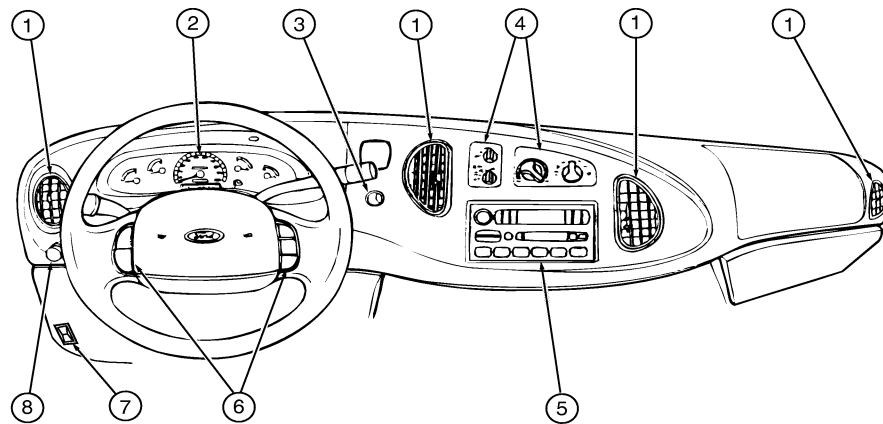

- | | |
|---------------------------------------|--------------------------------------|
| 1. Air Vents | 5. Audio System* |
| 2. Instrument Cluster* | 6. Speed Control (Cruise)* |
| 3. Cigarette Lighter/12V Power Outlet | 7. Aux. Start Switch (see page 2-8) |
| 4. Comfort Controls | 8. Headlight/Instrument Lamp Switch* |

**See Ford chassis operator's manual.



STEERING COLUMN CONTROLS

See your chassis operator guide for all controls located on the steering column or steering wheel.

WARNING

Do not operate the cruise control on icy or extremely wet roads, winding roads, in heavy traffic, or in any other traffic situation where a constant speed cannot be maintained.

COMFORT CONTROLS



AUTO AIR CONDITIONER/ HEATER

See your chassis operating guide for operating instructions for dash mounted automotive heater-air conditioner controls.

NOTE: The automotive air conditioner is not designed to cool the entire interior of the motor home, but is intended to cool the driver's compartment only.

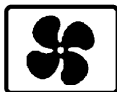

REAR AUTO HEATER

To provide auxiliary heat to the rear of the vehicle, turn the rear heater fan switch to the desired speed. This switch is located on the lower left dash panel as shown.

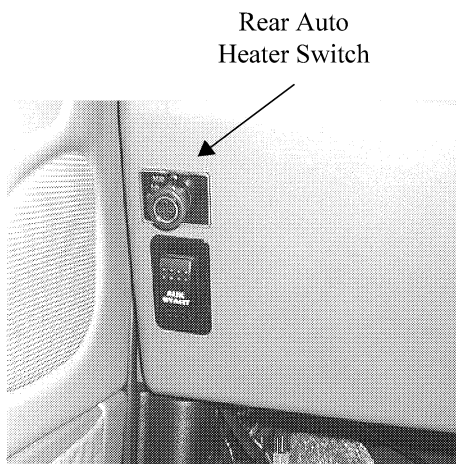

RADIO/CASSETTE PLAYER

Most vehicle models are available with a standard or optional AM/FM radio/cassette player that provides high quality stereo sound for your traveling and living enjoyment. Refer to your Ford chassis operating guide for operating and care instructions.

AUX. START SWITCH

This switch can be used to provide emergency starting power from the motor home auxiliary battery if the automotive battery is dead.

Aux. Start Switch



If engine battery is dead, press this switch while turning key for emergency starting power.

This switch is located on the lower left dash panel.

AUXILIARY BATTERY (Aux. Batt) SWITCH

The AUX BATT switch disconnects the auxiliary (coach) batteries from the 12-volt system of your coach to avoid long-term battery drain by electrical items that are hooked directly to the coach batteries.

Always leave this switch ON except during long storage periods (a month or more).

The auxiliary battery switch is located near the floor on the end of the cabinet to your left as you step inside the entrance door.

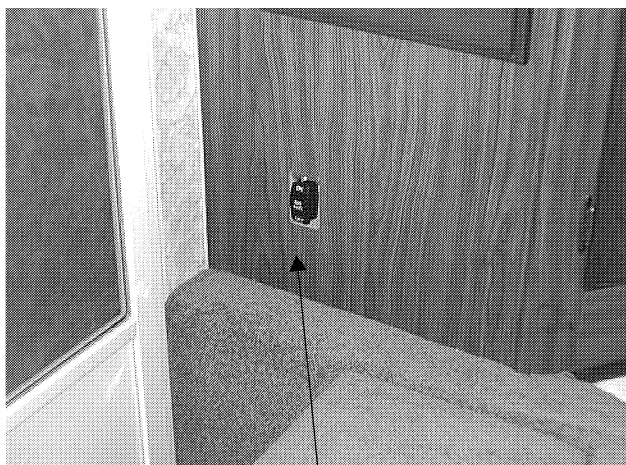

Aux. Battery Switch

WARNING
Keep all persons clear of the slideout room and moving parts while extending or retracting. Do not occupy the slideout room while it is being extended or retracted.

CAUTION
Be sure to allow adequate clearance (at least 2 feet) beside the vehicle to prevent damage when extending the slideout room. Be aware of items like cars, tree branches, etc., beside the vehicle.

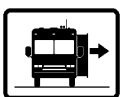

SLIDEOUT ROOM - Optional
Model 430V only

The slideout room provides expanded living area at the push of a button. The slideout room is extended and retracted using a hydraulic powered mechanism with an electronic control system. The slideout control switch is located on the end of an overhead cabinet just inside the entrance door.



Slideout Switch
on end of Galley Overhead Cabinet

Travel Straps (Slideout Room)

The Travel Straps **must be released before attempting to extend the room** or damage to the coach will result.

The travel straps are designed only to help keep the room extension secured against the coach sidewall to maintain an effective weather seal while the vehicle is in motion. They are not designed to withstand the force exerted by the hydraulic extension mechanism and will not prevent extension of the room.

Travel straps are located on the floor near the ends of the slideout room.

To Release:

- Pull the strap buckle outward and up to release tension on strap.
- Pull a short length of the excess strap back through the buckle to provide sufficient slack.
- Unhook the strap end pegs from the mooring brackets on the floor and wall edge. Store straps in location of your choice. (Under the couch is one choice.)

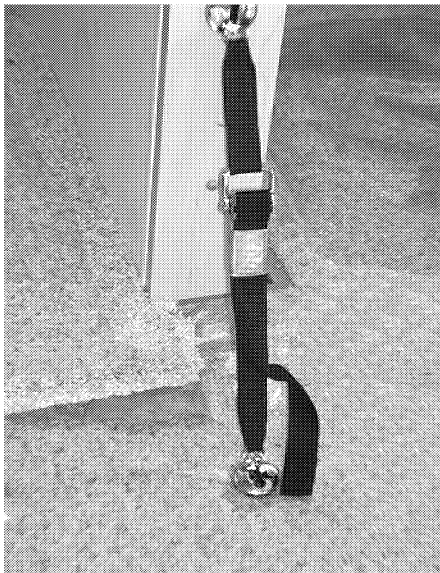

To Fasten Straps:

- Hook the strap end pegs into the mooring brackets.
- Flip buckle downward and press toward strap until it “snaps” snugly into place against the strap.
- If a strap is loose or too tight after closing the buckle, release the buckle and pull the loose end of the strap in or out to adjust tension as needed. Then reclose the buckle.

To Extend Slideout Room:

- Level the coach.
- Set the Parking Brake. An interlock relay system will then provide power to the slide-out control switch.
- Press the Slideout switch and hold until the room is fully extended, then release the switch.

To Retract Slideout Room:

- Set the Parking Brake to provide power to the slideout control switch.
- Press Slideout switch and hold until room is fully retracted, then release the switch.

CAUTION

Although there is an awning over the roof of the slideout room, there is a possibility of debris getting onto the roof. Because the slideout roof is drawn into the interior of the coach when retracted, be sure there is no debris, such as excessive dirt, tree seeds, twigs, leaves, etc, on the roof before retracting.

If Slideout Room Will Not Operate (Troubleshooting)

- The chassis battery may be low on charge. Press the Aux. Start switch on the dash to the momentary (MOM) position while pressing the slideout control switch. This momentarily connects the coach batteries to assist in retracting the room
- The circuit breaker may be tripped. The circuit breaker is located on an interior wall of a passenger side storage compartment just behind or ahead of the main entrance door.

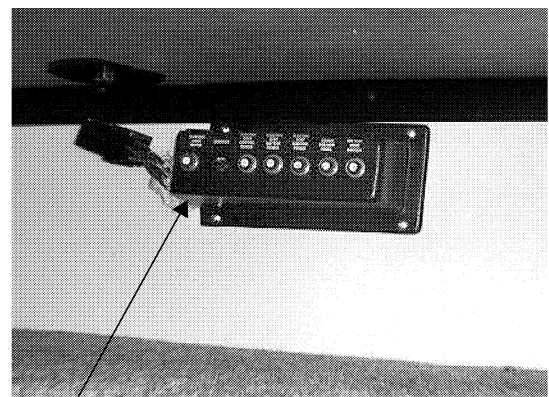

Slideout
Breaker

- If the batteries and breakers are okay, there may be a failure in the mechanism or electrical system. See “Manual Retracting Instructions” for help.

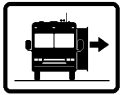

**Slideout Room Extension
Emergency Crank-In Procedure
(Use Only when room will not
retract using Control Switch)**

If a failure occurs in the slideout electrical or mechanical systems, and the room will not retract using the control switch, you can manually retract the room using the emergency crank assembly described below.

The pump is located on a bracket attached to the chassis frame beneath the coach about midway on the left side of the vehicle.

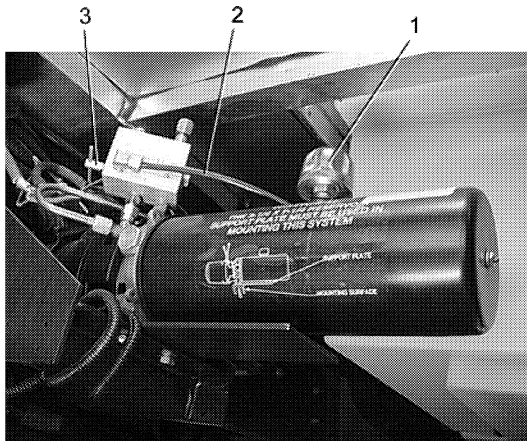

Step 1 - Relieve Hydraulic Line Pressure

- Remove fill cap⁽¹⁾ from hydraulic pump fluid reservoir beneath coach frame and insert bypass tube⁽²⁾ into reservoir. Turn relief valve T-handle⁽³⁾ on pump completely open (counterclockwise).

Step 2 - Install Winch Crank Assembly and Straps

The crank assembly is generally stored in the left rear cargo compartment. Assemble as shown in the illustration using the large L-shaped steel pin supplied with the crank.

- Remove cushions and seat board from forward facing dinette seat. Fasten crank frame to seat belt bolts on floor of dinette seat as shown. Extra nuts are provided on each of the two crank frame bolts for this purpose.
- Fasten one end of long, black nylon strap (supplied with crank) to bracket in galley rear side overhead cabinet. Fasten other end to bracket in front side overhead cabinet as

shown. Hook center of this strap into hook on winch strap as indicated.

- Lift front edge of sofa and pull out strap lying on floor beneath sofa. Hook looped end of this strap also into hook on winch strap as indicated.

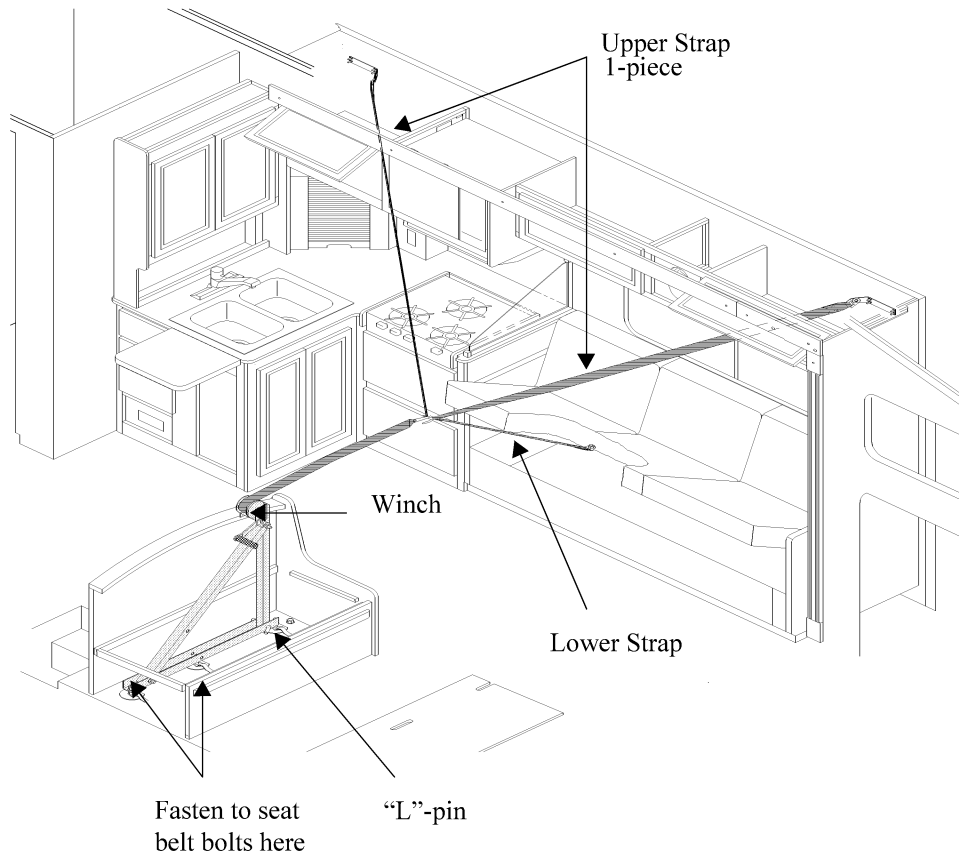

Step 3 - Crank Room Inward

- Be sure the winch ratchet pawl is in the locking position (against the gear teeth) before cranking. Crank the winch handle clockwise slowly.
- Begin cranking until all straps become taut, then crank slowly (a few “clicks” at a time, then wait a few seconds) so that both sides pull in evenly. **Allow about 10 minutes to crank room in fully.** (Attempting to crank the room in too quickly will raise fluid pressure in the hydraulic lines and make cranking more difficult.)

NOTE: If one side should get ahead of the other, the room will bind and the straps will become extremely tight. If this happens you must relieve pressure on the straps and push the leading side outward. Slide the winch strap hook slightly toward the trailing side, then resume cranking slowly.

- When the room is fully retracted, fasten travel straps, then unhook the winch straps and return the winch to its storage area. Release the straps by putting slight pressure clockwise on the crank handle, then moving the ratchet pawl lever to the unlocked, straight outward position.

WARNING

Do not attempt to continue cranking the room inward if binding occurs. Excessive tension could cause a strap to break or pull free, which could result in personal injury. Damage to the winch equipment, cabinets or coach sidewall could also occur.



NOTE: When you are done cranking the room in, you may notice on the outside that either the top or bottom of the room may still be gapping out from the sidewall a few inches. Unhook the strap for the side that is touching the sidewall, then continue cranking until the gapped side is snug. Reattach the other strap and snug up the crank to hold the room in.

Step 4 - Prep For Travel

- Before driving off, close T-handle bypass valve on hydraulic pump, pull bypass tube out of hydraulic fluid reservoir and replace cap to avoid contamination by road dust or debris while driving. You may notice that some hydraulic fluid has overflowed onto the ground while cranking. This is normal if the reservoir was full.

See your dealer for service of the slideout system before using again.

NOTE: When the system has been corrected, check fluid level and refill as necessary. Press the Retract switch for 15 to 20 seconds before attempting to extend the room. Then run the room out and in several times to purge any air from the hydraulic system. Finally, recheck fluid level and fill as necessary.

Further Information

See the HWH Room Extension operating guide included in your Owner InfoCase for further instructions and troubleshooting information.



HAZARD WARNING FLASHER

The hazard warning flasher provides additional safety when the vehicle must be stopped on the side of the roadway and presents a possible hazard to other motorists. When the flasher is on, it serves as a warning to the other drivers to approach and overtake your vehicle with caution.

WARNING

Operating the hazard warning flasher system while moving on the highway is illegal.

The front directional signals and the taillights will flash intermittently when the flashers are in operation. The hazard warning flashers will not operate when the service brake pedal is depressed. The turn signal will not operate when the flashers are on. When it is necessary to leave the vehicle, the flasher system will continue to operate with the ignition key removed.



IF YOU GET A FLAT TIRE

In case of sudden tire failure, avoid heavy brake application. Tire manufacturers recommend accelerating briefly to regain steering stability, then gradually decreasing speed. Avoid quick steering movements. Hold steering wheel firmly and move slowly to a safe, off-road place. Park on a level spot, turn off the ignition, and turn on the hazard warning flasher system.

SPARE TIRE STORAGE

The spare tire is fastened to a swing-down carrier beneath the rear of the coach.

WARNING

Do not lie beneath tire carrier while removing tire. The tire and carrier assembly are heavy.

- Support tire carrier with a jack or block while removing wire pin and wing nut from bolt at front of carrier.
- Carefully lower tire carrier to ground.
- Remove 2 bolts and retainer plate that hold wheel to carrier bracket.
- Lift or slide tire from carrier.
- Do not over-tighten wing nut when returning carrier to storage position.

MOTOR HOME JACKING AND TIRE CHANGING PROCEDURE

Follow the chassis manufacturer's recommendations for jacking and tire changing. These instructions are found in the chassis operating guide in your Owner Infocase.

A jack is designed for use as a tool for changing tires only, not for use as a leveling device or as a support for service purposes.

TIRE CHANGING SAFETY PRECAUTIONS

Before attempting to change either the front or rear tires, the following precautions should be headed:

1. Park vehicle on level surface only.
2. Turn off engine and set parking brake.
3. Activate hazard warning flasher.
4. Block both front and back of wheel opposite wheel to be removed.
5. On soft ground, use a board or other material under jack as a firm base to ensure that the jack will not shift.

WARNING

DO NOT crawl under the vehicle when it is supported by a jack.



SECTION 3 IN CASE OF DRIVING EMERGENCY

Minnie Winnie

NOTE: When installing the outboard rear dual wheel and tire assembly, rotate the outer dual wheel so valve stems are accessible but not touching one another. In some cases this means that the inner and outer valve stems should be in separate wheel cutout locations.

When installing or tightening dual wheels, both wheels on the same side must be off the ground (not resting on the inner dual). This minimizes the possibility of loose wheels after correct mounting torque is applied.

WHEEL NUTS

To properly seat the wheel nuts and to eliminate the possibility of the wheel nuts becoming loosened while driving, they should be tightened at frequent intervals to the torque specified in your Ford chassis manual. This is especially important during the first 100, 1,000 and 6,000 miles of operation after replacement of a wheel or wheel nuts.

WARNING

The operator is advised to obtain road service whenever possible and attempt tire changing under emergency conditions only and with close adherence to instructions. If it becomes necessary to change a wheel, that wheel should be checked after being properly torqued and inspected by qualified service personnel, at 100 miles and every oil change thereafter.

Upon satisfactory completion of emergency tire change, it is highly recommended that the wheel nuts be properly torqued and inspected by qualified service personnel as soon as possible.

Winnebago Industries does not assume responsibility for damage incurred while towing this vehicle.

WARNING

Stay out from beneath the motor home while it is suspended by the towing assembly unless the vehicle is adequately supported by safety stands. Do not allow passengers to occupy a towed vehicle.

NOTE: Know and obey all state and local towing regulations. Tow at reduced speed.

JUMP STARTING

WARNING

Automotive batteries produce caustic acid, explosive gases, and electrical current which may cause burns. It is important that the instructions below are followed **exactly**, or personal injury (particularly to eyes) or property damage may result due to battery explosion, battery acid, or electrical (short circuit) burns.

- NEVER smoke near the battery or expose it to open flame or electrical sparks.
- Wear eye protection or shield your eyes while working near battery, in case an explosion does occur. NEVER lean over a battery.
- Do not allow battery fluid to contact eyes, skin, clothing, or painted surfaces. Immediately flush any contacted area with water. If eyes are affected, seek medical help after flushing.
- Remove all metal jewelry to lessen the risk of a short circuit occurring.



RECOVERY TOWING

See your Ford Owner's Guide for proper recovery towing procedures.

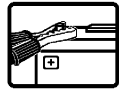

CONNECTING JUMPER CABLES

1. Make sure that the other vehicle has a 12-volt battery and negative ground compatible with your vehicle's electrical system.
2. Position the vehicle with the good battery so that the jumper cables will reach, but **do not allow the vehicles to touch.**
3. Turn off all electrical accessories, motors, and lights except those needed for safety or to light up the work area. Place automatic transmission in P (Park). Be sure parking brakes are engaged in both vehicles.
4. If the weak battery has filler caps, make sure the electrolyte is at proper level. Add distilled water if fluid is low. If electrolyte is not visible or appears to be frozen - **do not attempt jump starting!** A battery may rupture or explode if the electrolyte is frozen or not filled to the proper level.
5. Connect one end of the positive "+" (red) jumper cable to the positive "+" terminal of the weak battery. Connect the other end to the positive "+" terminal of the charged battery.
6. Connect one end of the negative "-" (black) jumper cable to the negative "-" terminal of the charged battery.
7. Finally, connect the remaining end of the negative "-" (black) cable to a solid, metal grounded location on the engine of the vehicle with the weak battery, at a point at least 18 inches from the battery. Do not connect to any moving parts. **THE MAIN SAFETY PRECAUTION IS TO MAKE THE FINAL GROUND CONNECTION ON THE ENGINE AT A SAFE DISTANCE FROM THE BATTERY. THIS HELPS TO REDUCE THE CHANCE OF EXPLOSION DUE TO SPARKS.**
8. Start the engine of the vehicle with the charged battery, and allow it to run for a few minutes at moderate r.p.m. Then start the engine of the vehicle with the discharged battery.
9. Reverse the above sequence **EXACTLY** when removing the jumper cables. Start by

removing the cable from the ground location on the engine first, then continue in reverse sequence.

WARNING

Do not attempt to push-start this vehicle. Damage to the transmission or other parts of the vehicle could occur.

CONNECTING A BATTERY CHARGER

To connect a battery charger, first make sure the engine is switched off. Disconnect the positive (+) lead from the battery. Never disconnect the battery while the engine is running or alternator damage could result.

Connect the positive "+" (red) lead of the charger to the positive "+" terminal on the battery. Next, connect the negative "-" (black) lead of the charger to a suitable ground. Finally, plug in or switch on the charger.

To disconnect the charger after charging, unplug the charger from the electrical outlets, remove the charger leads from the vehicle, and reconnect the vehicle leads to the battery.



ENGINE OVERHEAT

If you see or hear steam escaping from the radiator or the engine compartment or have any other reason to suspect an extreme engine overheating condition, pull the vehicle over to the roadside as soon as it is safe to do so, stop the engine and get out of the vehicle.

WARNING

Operating a vehicle under a severe overheating condition can result in damage to the vehicle and may result in personal injury.

An engine will overheat if the coolant is low or there is a loss of coolant because of one or more of the following:



SECTION 3 IN CASE OF DRIVING EMERGENCY

Minnie Winnie

- a leak in the cooling system
- a hose failure
- a drive belt breaking
- water pump failure

Also, be aware of the following situations, which can cause temporary engine overheating:

- climbing a long hill on a hot day
- idling while stopped in traffic for long periods of time
- towing a trailer or automobile
- stopping after a period of high speed driving

If the TEMP indicator on the instrument panel shows a rise in engine coolant temperature while driving, take the following steps to attempt to lower the overheating condition:

- If you are using the automotive air conditioner, turn it off.
- If you are stopped in traffic, shift the transmission into P (Park), and engage parking brake.

If the temperature does not drop within a minute or two:

- Pull the vehicle over to the roadside as soon as it is safe to do so.
- Place the transmission in P (Park) and press the accelerator to increase engine speed (r.p.m.'s) to twice that of normal idle speed, and hold it there for approximately two or three minutes.
- If engine temperature does not go down, turn the engine off and wait until the engine has cooled before attempting to open the hood.

When no trace of escaping steam is heard or seen, open the hood to check for the cause of the overheat. Check hose connections and tighten if necessary. Make sure there are no broken belts, pulleys or hoses before adding any coolant to the radiator.

For further information in case of overheating, consult your chassis operating guide.



TRAVELING WITH YOUR MOTORHOME

(See also SAFETY PRECAUTIONS, Section 1 of this manual.)



LOADING THE VEHICLE

When loading the vehicle, distribute the cargo load equally so that you do not exceed either the Front or Rear Gross Axle Weight Rating (GAWR) or the Gross Vehicle Weight Rating (GVWR). The Gross Axle Weight Rating (GAWR) means the weight value specified by the chassis manufacturer as the load carrying capacity of a single axle system as measured at the tire-to-ground interfaces. This is the total weight a given axle is capable of carrying. Each axle has its own rating.

Also distribute cargo side-to-side so the weight on each tire or dual set does not exceed one half of the GAWR for either axle.

For example, if the Front GAWR is 6,000 lbs., there should be no more than 3,000 lbs. on each tire. (If the left side weighs 3,100 lbs. and the right side weighs 2,700 lbs., at least 100 lbs. of the load should be shifted from the left side to the right side.)

Have your vehicle weighed to determine the proper load distribution for your vehicle. The GVWR is listed on the Vehicle Certification Label. (See page 0-3.)

The total combined weight allowed for the vehicle, including trailer towing load weight, is known as the Gross Combined Weight Rating (GCWR). If trailer towing is not recommended, the GCWR will equal the GVWR.

NOTE: See the Ford Recreation Vehicle and Towing Guide for maximum towing capacities and GCWRs. These guides are available from your local Ford dealer.

Your cargo capacity will vary according to the options equipped on your vehicle, and your additional equipment and components not supplied with the vehicle. Do not exceed any of the recommended weight ratings.

NOTE: We recommend that you dump all holding tanks before traveling to avoid carrying unnecessary weight.

CAUTION

The weight of the loaded vehicle (including options, attachments, passengers, water, fuel, luggage and all other cargo) must not exceed the GVWR or GAWR of either axle.



FRONT AXLE TIRE ALIGNMENT

We recommend that you have the front suspension and steering alignment checked and adjusted after you have fully loaded the vehicle according to your needs. Thereafter, have alignment inspected periodically to maintain vehicle steering performance and prevent uneven tire wear.



WEIGHING YOUR LOADED VEHICLE

To check the weight of your fully loaded coach, locate a commercial weighing scale that is capable of weighing large trucks.

Drive the entire coach onto the scale. This weight should not exceed the Gross Vehicle Weight Rating (GVWR) specified on the Vehicle Certification Label near the driver seat. (See sample on page 0-3).

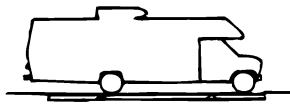

GVWR
(Both Axles)

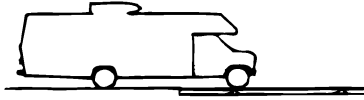

Front GAWR
(Front Axle Only)

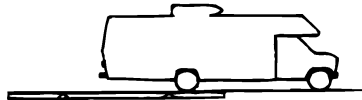

Rear GAWR
(Rear Axle Only)

Weighing Your Motor Home

To determine the weight on either the front or rear axle, drive that axle only onto the scale. Neither axle weight should exceed the corresponding maximum axle weight rating specified on the certification label.



MAXIMUM OCCUPANCY

The following label is placed in a visible location in the driver compartment.

BELTED SEATING POSITIONS MAY EXCEED SLEEPING CAPACITY OF THIS VEHICLE. SEE OWNERS MANUAL FOR OCCUPANCY AND WEIGHT RESTRICTIONS.

The number of belted seating positions in your motor home may exceed the number of people used to determine maximum coach occupancy, called the Net Carrying Capacity (NCC) in the U.S. or Cargo Carrying Capacity (CCC) in Canada.

To calculate the NCC or CCC, Winnebago uses vehicle sleeping capacity, however your coach may be equipped with more belted seating positions than sleeping positions to give passengers a choice of seating arrangements. You may use all of the belted seated positions providing

you stay within your vehicle's GVWR listed on the Vehicle Certification Label (see page 0-3). However you use or load your vehicle, it is your responsibility to keep the weight within its stated gross vehicle weight rating.



ROOF LOADING

The roof on most models is capable of carrying some lightweight articles while the vehicle is in motion. A roof-mounted luggage carrier designed for this purpose is available from your dealer. However, roof load while the vehicle is in motion is not to exceed 10 pounds per square foot or a maximum of 100 pounds.

When the vehicle is stationary, a cargo load of 100 pounds plus the weight of a 225 pound person to load the cargo or to conduct inspection and maintenance is permissible.

Weight added to both the roof and the trailer hitch contribute to the gross vehicle weight, which must not exceed the vehicle's GVWR.



CAR OR TRAILER TOWING

The factory installed towing hitch on this coach is capable of pulling 3,500 lbs. (max.) and carrying 350 lbs. (max.) on the hitch ball. However, your coach's towing and hitch ball capacity may be less due to the coach's loaded weight and/or the towed vehicle's weight and hitch ball weight. The combined weight of the coach and the towed vehicle should not exceed the coach's Gross Combined Weight Rating (GCWR). Also, the combined weight of the coach and the towed vehicle's hitch ball weight should not exceed the coach's Gross Vehicle Weight Rating (GVWR) or its rear Gross Axle Weight Rating (GAWR) listed on the Vehicle Certification Label.

Because of individual vehicle use and loading habits, we recommend weighing the vehicle while fully loaded to avoid exceeding any of the listed Gross Weight Ratings. See "Vehicle Certification Label" on page 0-3 for information on gross weight ratings.



Towing will affect vehicle handling, durability and fuel economy. Exceeding any of the listed Gross Weight Ratings will result in unacceptable overall vehicle performance. Maximum safety and satisfaction when towing depends on proper use of correct equipment. A hitch bar of appropriate steel and size should be selected to mate with the Winnebago towing receptor.

Installation of a proper trailer brake system is recommended. Check state regulations on trailer weight and trailer brake requirements to be sure you select the right equipment before towing.

NOTE: If you tow a car or trailer that weighs over 1,000 lbs., it must be equipped with automatically activated brakes. See the Ford Recreation Vehicle and Trailer Towing Guide for maximum towing capacities and GCWRs. These guidelines are available from your local or Ford dealers.

Before descending a steep or long grade when towing a trailer, reduce speed and shift into a lower gear to control vehicle speed. Avoid prolonged or frequent application of brakes which could cause overheating and brake failure.

WARNING

For safety towing and vehicle handling, maintain proper trailer weight distribution.

The total weight of the motor home and the vehicle towed must not exceed the Gross Combined Vehicle Weight rating. Contact the chassis manufacturer to obtain the Gross Combined Vehicle Weight rating for your chassis.

CAUTION

Exceeding any of the recommended gross vehicle weight ratings may result in vehicle damage.

Do not install a frame equalizing type hitch on your vehicle.

See also - Trailer wiring connector, page 6-8.



PRE-TRAVEL CHECK LIST

Before starting the engine to leave on a trip, be sure your motor home has been properly prepared and maintained. This will ensure an enjoyable trip and help avoid delays. Use this checklist as a guide.

- Fluid Levels - Check and fill if necessary:
 - engine oil
 - transmission
 - power steering
 - radiator
 - brake
 - battery
 - windshield washer
- Wheel Lug Nuts - Check for tightness
- Tires - Check for proper cold inflation pressures as specified on the Vehicle Certification Label.
- Drive Belts - Check for proper condition and tension (not cracked, frayed, or loose, etc.)
- 110-Volt Generator (Optional) - Check oil level in generator engine.
- Fire Extinguisher - Make sure it is fully charged and secured in mounting bracket.
- Lights - Make sure all exterior lights operate.
- Sewer and Water Supply Hose - Unhook and store.
- TV Antenna - Make certain the TV antenna is lowered and seated in its support cradle.
- Loose Items Inside the Motor Home - Store or secure items.
- Pilot Lights - Make sure all pilots are off.
- Fuel Tanks - Check level.
- Water Tank - Fill with fresh water.
- Exterior Door and Step - Make sure doors are closed, locked and step retracted.
- Seats - Adjusted for comfortable position and locked in place.
- Mirrors - Adjust for maximum visibility from driver's seat.



TRAVEL TIPS

As you travel around the country in your motor home, you will pick up useful advice from other motor home owners.

A number of suggestions can also be obtained by reading articles and regular columns in outdoor and camping magazines. Some magazines and publishing companies print an annual park and campground directory. These can be found at your local news stand or RV supply dealer. Here are a few travel tips to begin with.

1. Always check for sufficient clearance. Know the height and width of your unit.
2. Always fill the fresh water tank at an approved potable water filling facility or a known purified drinking water source. Taste the water before filling the water tank in an unfamiliar location. The water in some areas may contain an undesirable taste. Do not use a new hose to fill the water tank. It can leave a distinct rubber or vinyl taste.
3. Showers can take a lot of water. Conserve water by taking a "Sea Shower". This is done by wetting down, turning off the water, soaping thoroughly and then rinsing.
4. Dump sewage only at approved dumping stations.
5. Store liquids in plastic containers with tight fitting caps to prevent spills.
6. Keep an eye on the water and holding tank levels. It is a good idea to dump the holding tank at least every two days.
7. When traveling with children, it is helpful to plan their wardrobe for a week. Place each days clothing in a plastic bag and label the bag with the child's name and day of the week for use.
8. Use sleeping bags whenever possible. They save laundry and take up less storage space than bedding.
9. Make sure all compartment doors have been closed and the door step has been stowed in the correct position before moving the vehicle.
10. Before traveling, make sure the refrigerator door has been secured. Use care when opening the refrigerator door after the vehicle has been stopped. Any articles that have shifted may fall out when the door is opened.
11. During peak tourist season and holidays, it is best to phone ahead and make reservations at the park where you plan to stop.
12. Some states or cities will not permit vehicles with LP gas containers to pass through highway tunnels. If your route includes a tunnel, check with the highway patrol or department of highways to avoid inconvenience.
13. Do not leave food or odor-causing material in your vehicle for extensive periods of time. Always allow damp clothing, swimwear, hunting gear, etc., to dry before stowing.
14. Become familiar with the fire extinguisher and make sure it is always fully charged. Remove and replace it and read instructions so you know the correct operating procedure before an emergency happens.
15. Make a list of all groceries, fresh meats, vegetables, newspapers, etc., that you may need and try to pick them up during your last fuel stop of the day. This will prevent leaving a good parking spot once you have arrived at your destination.
16. When you sit over the front wheels while driving, as in a motor home, you have a tendency to crowd the middle of the road. Check the side view mirror frequently to observe how close you are driving to the center line.



SEVERE WEATHER INFORMATION

One of the more serious conditions affecting the motor home traveler and camper is that of the weather. Whether you travel the high mountain terrain, the lower deserts and flatland or the plains of the midwest, the weather is always with you and subject to change, sometimes with little or no warning. However, adequate warnings are normally broadcast over local radio and TV stations.

Motor home travelers and campers often seek secluded areas for weekend recreation or extended summer vacations. Many recreational areas are vulnerable to severe weather situations, especially flash flooding conditions. A few simple precautions may help lessen the hazards of flash flooding or reduce your immediate involvement.



NOTE: We recommend that all motor home occupants become familiar with these safety precautions, and be alert to change in weather.

- Be alert, because thunderstorms can form at any time, in any month of the year. Thunderstorms can produce large amounts of rain over a small area in a short time, which may result in a flash flood. Listen frequently to weather reports on the radio for weather and flood conditions.
- When camping near a stream, leave plenty of sloping bank between you and the stream.
- Avoid deep canyons and dry washes during stormy or threatening weather. Be aware of alternate exits.
- If heavy rain occurs, move to high ground immediately (at least 30-40 feet above the canyon floor or bottom of dry wash).
- During a flash flood, if you cannot move your vehicle, abandon it. Do not attempt to return to your vehicle before the water has receded.
- Do not attempt to wade to your vehicle if the water is above your knees - fast moving water exerts an enormous amount of pressure, making it impossible to remain standing or walking.
- Do not try to drive through flooded areas.
- Follow instructions of local authorities. Leave immediately when advised to do so. Many lives have been lost because people did not heed warnings.
- Have on hand survival supplies for several days, including food, water, first aid equipment and necessary medications. In desert areas during hot weather allow 3-4 gallons of drinking water per person, per day.
- Before you leave home, inform someone of your destination and when you expect to return. Authorities at your destination should be notified immediately if you do not arrive on time.

REMEMBER THESE TERMS:

WATCH: Severe weather may develop in the specified area. Be alert and prepare for possibility of an emergency.

WARNING: Severe weather is occurring or is imminent in certain areas. Move to a safe location immediately.

We highly recommend that you obtain a weather radio. These radios offer up-to-date weather reports. The latest information and forecasts are broadcast by local National Weather Service offices in recorded messages that last from three to five minutes. These messages are replayed continually 24 hours a day. The recorded messages are revised every three to four hours, or more frequently when appropriate.

When severe weather threatens, forecasters at the local National Weather Service office interrupt the broadcasts with storm warnings, either recorded or “live” as the situation demands.

The frequencies used for NOAA Weather Radio (National Oceanic and Atmospheric Administration) nationwide are 162.40, 162.475 or 162.55 megahertz.



NIGHTTIME DRIVING

- Make sure all running lights and signal lights are clean and in working order. Have your headlights periodically checked and adjusted.
- Use care when passing other vehicles. Your motor home is a longer vehicle than a car, and you may have a more difficult time knowing when to pull back into your lane. If possible, have another person in the coach help you watch while maneuvering your motor home in traffic.



MOUNTAIN DRIVING

Special techniques must be used when driving in mountainous or hilly country.



Climbing A Hill

The transmission will automatically downshift as needed to climb most hills. If the hill is long or very steep, however, you may need to manually shift to a lower gear to keep the transmission from repeatedly upshifting and downshifting. Select the lowest adequate gear range for the duration of the incline. See your chassis operating guide for more information.

CAUTION

Observe the engine temperature gauge more frequently than normal. If overheating occurs, pull off to the side of the road and allow the engine to thoroughly cool before refilling the radiator and restarting the engine.

Descending A Hill

When going down a long grade, you may need to manually shift to a lower gear, rather than keeping your foot on the brake pedal. A lower gear will allow the engine to provide a degree of braking action. Holding your foot on the brake pedal for an extended period may cause brakes to overheat, causing you to lose control of the vehicle. See your chassis operating guide for more information.

CAMPSITE SET-UP

Try to pick as level a spot as possible on which to park your motor home.

Leveling the motor home is very important, not only for your comfort, but for plumbing and appliances as well. Some refrigerators are extremely sensitive to being off level. The ammonia vapor cooling system used in most RV refrigerators can “lock up” and damage the refrigerator if it is not level. This is both inconvenient and costly. Also, water and holding tank level indicators may give false readings because water level is greater at one side of the tank than the other.

Blocking

A motor home can be leveled using several methods, including sophisticated electronic-hydraulic systems. The most common and inexpensive method, however, is “blocking.”

This is done by stacking various lengths of planking (blocks) into a ramp-like formation in a low spot to drive the tire onto, thus leveling the coach as shown.

Wedge a pair of wheel chocks or similar devices in front and back of a tire that is on the ground as shown to keep the coach from rolling forward or backward off the leveling blocks.

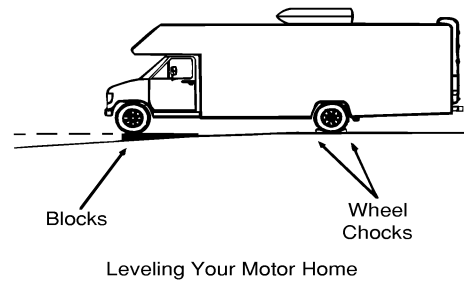

When placing blocks beneath a set of rear dual wheels, be sure the blocks support **both** tires so that the load weight is not resting on one tire, which could damage that tire.

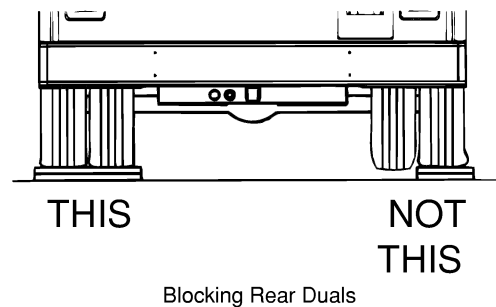

To provide extra firmness, you can place inexpensive mechanical jacks, jack stands or hydraulic “bottle” jacks under the frame to keep the coach from moving on the suspension springs while walking around inside the coach. These devices are not intended to lift the coach; only to hold it rigid and steady.

NOTE: We do not recommend lifting any of the wheels off the ground for leveling. This could allow the coach to roll off the jacks, possibly resulting in damage to the vehicle.



EFFECTS OF PROLONGED OCCUPANCY

Your motor home was designed primarily for recreational use and short term occupancy. If you expect to occupy your coach for an extended period, be prepared to deal with condensation and humid conditions that may be encountered.

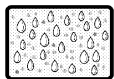

HUMIDITY AND CONDENSATION

Moisture condensing on the inside of windows is a visible indication that there is too much humidity inside the coach. Excessive moisture can cause water stains or mildew which can damage interior items such as upholstery and cabinets.

When you recognize the signs of excessive moisture and condensation in your coach, you should take immediate action to minimize their affects.

You can help reduce excessive moisture inside the motor home by taking the following steps:

Ventilate with outside air: Partially open one or more windows and a roof vent to circulate outside air through the coach. In cold weather, this ventilation may increase use of the furnace, but it will greatly reduce the condensation inside the coach.

Minimize moisture released inside the coach: Run the range hood fan while cooking, and open a bath vent while bathing or showering to carry water vapor out of the coach. Avoid making steam from boiling water excessively or letting hot water run. Avoid bringing extra moisture into the coach by way of soaked clothing or snow on shoes. Do not hang-dry wet overcoats or clothing inside the coach.

NOTE: Your coach is not designed or intended to be used as permanent housing. Using this product for long term occupancy or permanent housing may lead to premature deterioration of structure, interior finishes, fabrics, carpeting and drapes. Damage or deterioration due to long term occupancy may not be considered normal and, under the terms of the war-

ranty, may constitute misuse, abuse, or neglect, and may therefore reduce your warranty protection.



(See also Safety Precautions, Section 1 of this manual.)



LP GAS SUPPLY

The LP gas system supplies fuel for the range, water heater, furnace and refrigerator (while in gas mode). When used and handled properly, this system is safe and economical and provides modern living conveniences wherever you travel.



SAFE USE OF THE LP GAS SYSTEM

The LP system is designed and built with strict adherence to both federal and recreational vehicle industry requirements for mobile LP gas equipment.

For your safety, there are many safety devices and backup systems installed, such as tank fill overflow valves, an interior LP gas detector/ alarm, and an interior carbon monoxide (CO) detector/alarm.

LP gas also contains an odor additive that you can smell if LP is present in the air.

Listed below are a few precautions to observe that will help you to use the LP gas system safely.

- Exercise caution at all times. Be familiar with the distinctive odor of LP gas. If a leak is suspected, turn off the supply valve immediately. Have the LP gas system checked by your dealer or a qualified LP gas service center.
- Do not tamper with the LP gas piping system, pressure regulator or gas appliances. Service and maintenance of LP gas system components should be performed only by your dealer or a qualified LP gas service center.
- Never attempt to connect natural gas to the LP gas system.

- Have the entire LP gas system inspected for possible leaks and missing or damaged parts at each tank filling. Also inspect before and after each trip, and any time trouble is suspected.
- Turn the LP supply valve off when not using the LP gas system.
- Never use a wrench to tighten the tank supply valve. It is designed to close leak-tight by hand. If a wrench is required to completely close the valve, it is defective and must be replaced.
- Never allow the tank to be filled above the 80 percent level indicated by the flow of liquid gas out of the overflow valve or by the automatic stop-fill device.
- Be sure appliance and outside vents are open and free from obstruction when using the LP gas system.
- Never attach a lock or any device requiring a key to the LP tank compartment door. According to standards set for recreation vehicles, the LP supply valve must be readily accessible in an emergency.
- Exercise caution when drilling holes or attaching objects to the walls. Gas lines and electrical wiring could be seriously damaged and present an extreme safety hazard.

HOW LP GAS WORKS

LP (Liquefied Petroleum) gas is a true gas compressed into liquid form for easy transportation and storage. LP gas is available in two types - propane and butane. It is also called tank gas, bottle gas, or simply LP.

LP is used by appliances in vapor form only, but is stored in the tank as a liquid under very high pressure. As the liquid gas is released, it reverts back to a vapor and expands to many times its compressed volume.



SELECTING LP FUEL TYPES

We recommend using straight propane in your LP tank. Propane gas is commonly available at all LP gas outlets in the U.S. (According to the National LP Gas Association, LP gas outlets in the United States do not offer any other type of liquefied petroleum gas than propane to the general public.) Check local phone directory yellow pages for locations of local LP gas refilling stations or bulk dealerships.

NOTE: If you travel outside the U.S. with your motor home, you may find butane or propane/butane mixtures available in addition to propane. Because gas-burning RV appliances are designed to run on propane only, we recommend that you request straight propane only. Butane burns about 30 percent hotter than propane and can overheat some appliances, particularly refrigerators, and cause permanent damage. Other appliances designed to operate on propane can become sooted and lose efficiency by using butane fuel.

Propane is commonly available in most locations. LP gas used as a motor vehicle fuel (for tractors, generators, forklifts, etc.) must be pure propane, so even in areas where butane mixtures may be sold, you can assure that you are getting pure propane by filling at an LP refilling station that sells motor fuel LP. Check local phone directory yellow pages for these LP gas refilling stations.

Butane is typically sold only in warmer climates and is not normally sold in northern states. See also *Winter Use of LP Gas* on page 5-5.

LP GAS OUTPUT

Each gallon of liquid LP gas contains approximately 92,000 BTU's of heat energy; or about 36.2 cubic feet of dry gas for cooking, heating, water heating and refrigeration.

To find out how long a gallon of LP gas will last, you should determine the total BTU **input** on all your LP gas appliances in use. Let's say you have a furnace that has a 10,000 BTU **input** per hour of operation. A gallon of LP gas would last 9.2 hours of continuous operation (92,000 BTU's ÷ by 10,000 BTU's = 9.2). To estimate how long a gallon of LP gas lasts, try to determine what your total daily BTU input is, then divide into 92,000 to arrive at an approximate daily LP gas consumption.

LP TANK SYSTEM

The storage reservoir for the LP gas system is a horizontally mounted tank which is permanently attached to the vehicle frame. The tank is accessible only from the outside of the vehicle. The tank supply valve is located near the top center of the tank, next to the regulator. Before opening the supply valve, check to be sure all controls for gas appliances are in the "Off" or "Pilot Off" position. If this step is not performed, LP gas could accumulate inside the motor home creating a fire or explosion hazard.

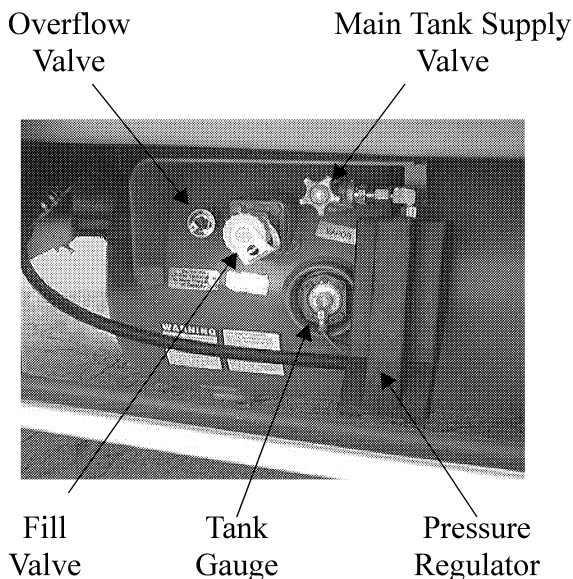

LP Gas Tank Capacity:

All Models..... *14.4 gal.* (18 gal. w.c.)



**LP Gas tank capacity shown is the usable "full" LP gas capacity, which is 80% of the tank manufacturer's listed water capacity (w.c. shown in parenthesis). An LP tank must have at least 20% of tank volume free to allow for expansion and proper ventilation of the liquid fuel. The tank is also equipped with mandatory safety shut-off equipment that prevents filling above this level.*

REFILLING LP TANK

There are many LP gas refueling stations located throughout the country. These stations are listed in the telephone directory Yellow Pages under "Gas - Liquefied Petroleum - Bottled and Bulk."

Since the LP tank is permanently mounted to the frame, the motor home must be taken to an LP dealership for filling. Do not attempt to remove the LP tank from the vehicle. The tank is equipped with a fill adapter with both internal and external threads which allows easy filling with any LP filling equipment. The tank is full when liquid LP gas appears at the overflow valve.

NOTE: The LP tank is equipped with an automatic 80% stop-fill device.

AIR IN THE LP GAS TANK

If your LP gas appliances do not stay lit or require frequent adjustment, even though you know the LP tank contains sufficient fuel, the problem may be air in the LP gas tank. Air in the tank mixes with the LP gas vapors causing them to burn poorly. This condition could linger for weeks if the air is not purged from the tank. Most LP gas dealers have equipment for purging air from LP gas tanks and will purge before refilling the tank.

TRAVEL WITH LP GAS

It is illegal for vehicles equipped with LP tanks to travel on certain roadways or through certain tunnels in the U.S. To avoid inconvenience, check state regulations concerning flammable gas transportation.

WARNING

DO NOT FILL CONTAINER TO MORE THAN 80 PERCENT OF CAPACITY. Make sure the motor home is level when filling. It is possible to accidentally overfill the tank if the vehicle is unlevel, with the fill valve on the uphill side. Overfilling the LP gas tank can result in uncontrolled gas flow, which can cause fire or explosion. A properly filled container will contain approximately 80 percent of its volume as liquid LP gas.

All pilot lights must be extinguished and supply valve closed before refilling LP gas tanks or vehicle fuel tanks.

Do not smoke or expose an open flame while near an LP refueling area. LP gas is heavier-than-air and extremely flammable.

Never use an open flame to test for LP gas leaks.

Replace all protective covers and caps on LP system before filling.

Never fill the LP tank with engine or generator running.

REGULATOR

The pressure regulator is protected from the elements by a plastic cover which should be left in place at all times. Only your dealer or a qualified LP gas service should remove the regulator cover for adjustments.



WARNING

Inspect the pressure regulator vent hole periodically for blockage. If any obstruction is apparent, have the regulator serviced by your dealer or a qualified LP gas service center.

LP gas regulators are installed with the diaphragm vent facing downward. Make sure that the regulator vent always faces downward to minimize vent obstruction which could result in excessive pressure, causing a fire or explosion.

Regulator freeze-ups are caused by the presence of moisture in fuel. This moisture will pass through the cylinder valve and into the regulator where it can freeze. Fuel producers, tank and bottle manufacturers and LP gas dealers take every precaution to reduce moisture, but sometimes only a fraction of an ounce entering the tank can cause problems. To help avoid the possibility of freeze-up, always keep tank control valve closed when not in use, even when tank is empty, to prevent moisture from collecting on the inside.

If regulator freeze-up should occur, you may attempt to thaw the regulator using a light bulb. **DO NOT USE AN OPEN FLAME OR HEAT LAMP.**

Be sure vent hole is not blocked

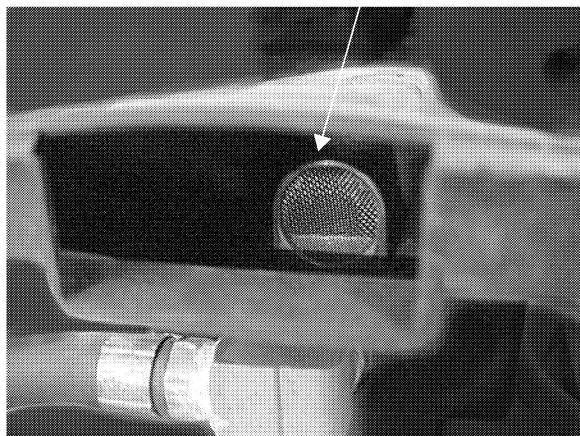

LP Gas Pressure Regulator
(View upward into open end of regulator cover)

If moisture begins to cause problems, have your LP gas dealer inject a small amount of dry methyl alcohol in your tank (approximately one ounce to 20 pounds or one pint to 100 gallons) to help guard against regulator freeze-ups.

In very cold weather when a large volume of gas is being used for heating, it is possible to experience a loss of gas pressure. At first, this problem may appear to be caused by a regulator freeze-up, but is actually caused by failure of the liquid gas to vaporize as fast as it is needed. As the temperature becomes colder, it is increasingly harder for the liquid LP gas to vaporize. At the same time, the demand for LP to produce heat increases to the point where the system cannot maintain production.

The only solution to this problem is to reduce the consumption of gas where possible. Adjusting the temperature on the gas/electric refrigerator may be a first step. Using less hot water will help as well.



LP GAS LEAKS

The following label has been placed in the vehicle near the range area. If you smell gas within the vehicle, quickly and carefully perform the procedures listed.

IF YOU SMELL GAS

1. Extinguish any open flames, pilot lights and all smoking materials.
2. Do not touch electrical switches.
3. Shut off the gas supply at the tank valve(s) or gas supply connection.
4. Open doors and other ventilating openings.
5. Leave the area until odor clears.
6. Have the gas system checked and leakage source corrected before using again.

WARNING

Never use an open flame to test for gas leaks. When testing for gas line leaks with a soapy water solution, DO NOT use a detergent containing ammonia or chlorine. These substances may generate a chemical reaction causing corrosion to gas lines, resulting in dangerous leak conditions.

Temperature	Percentage of BTU's Available at 0° F.
20° F.	200%
10° F.	150%
0° F.	100%
-5° F.	75%
-10° F.	50%
-15° F.	25%
-20° F.	12 1/2%
-44° F.	Propane will not vaporize

LP GAS ALARM - See page 1-2.



WINTER USE OF LP GAS

Due to vaporization characteristics of LP gas, it is important that the winter camper knows how to most efficiently use the LP system. The vaporization rate of LP gas decreases in a direct relationship to a decrease in temperature. Propane will convert to a usable gas at temperatures down to -44°F. For this reason, propane is a popular heating fuel in cold climates. However, even propane vaporizes at a slower rate as it becomes colder.

The greater the amount of liquid gas in the tank (up to 80% level) the greater the amount of LP gas vapor generated. The following is an example of the number of BTU's available from an 84-pound tank at 0° F at three levels. As you can see, the number of BTU's decreases as the tank is emptied. Nearly twice as many BTU's are available from a full tank than one that is one-fourth full.

BTU's Available at 0° F.	
Tank Level	BTU's
80%	64,000
50%	50,400
20%	33,000

The following LP Gas Vaporization and Temperature Relationship chart typifies the LP gas loss with a decrease in temperature. The percentage figures are the increase or decrease of vapor that would be available at 0°F. These figures apply to any size LP gas tanks.

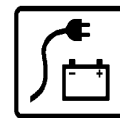

(See also Safety Precautions, Section 1 of this manual.)

Your motor home is equipped with an electrical system consisting of two separate voltages; a 12-volt DC system and a 110-volt AC system. The 12-volt system consists of two internal power sources, while the 110-volt system is operated from an outside power source or the optional 110-volt generator. All systems operate through a single power converter control center to provide electrical power to the motor home.

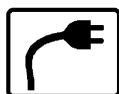

110-VOLT AC SYSTEM

The 110-volt system operates from an outside 110-volt utility service such as those at campgrounds, or from the optional 110-volt generator. When the power cord is connected to an outside power source, or when the generator is in operation, the power converter automatically changes a portion of the 110-volt current to 12-volt DC current. All equipment in the motor home that is normally powered by the auxiliary battery is then powered through the converter.

In addition, the following equipment is entirely dependent on 110-volt current: roof air conditioner, refrigerator (when placed in 110-volt mode), microwave oven, and any 110-volt electrical equipment used at convenience outlets.



EXTERNAL POWER CORD (Shoreline)

The external utility power cord (commonly referred to as a “shoreline”) is stored in the utility compartment on the left (driver’s) side of the coach.

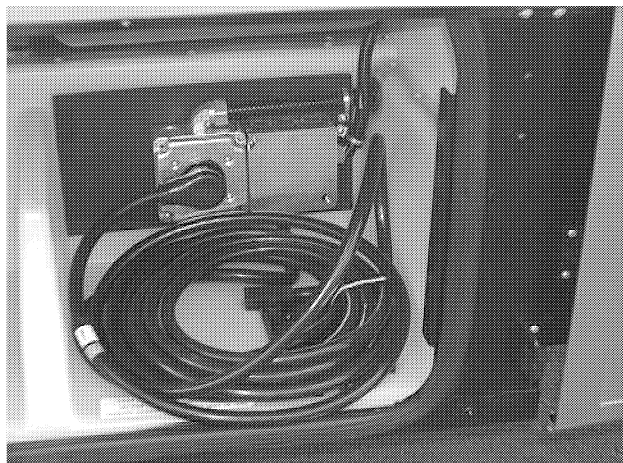

Shoreline Cord
Shown connected to generator outlet

WARNING

Do not connect the external power cord to any receptacle **until** you have contacted the owner and/or attendant of the premises to verify proper polarity and grounding.

It is the responsibility of the owner of the electrical receptacle to ensure that the receptacle is properly wired and grounded.

Reverse polarity and improper grounding of the vehicle can cause personal injury or death

To connect to an external power source, remove the cord from the storage compartment and plug it into a suitable power receptacle.

An access hatch in the compartment floor lets you route the shoreline cord out the bottom of the compartment so you can close the compartment door while the shoreline is connected.

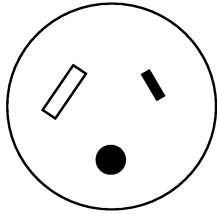

30 Amp Receptacle

The three-prong power cord is designed to ground the electrical system through the receptacle. It is also designed to carry the amperage output of most campground outlets. If the electrical receptacle to be used is designed to mate with the three prongs on the power cord plug, the electrical connection can be expected to carry rated load. (See approximate power consumption table on page 6-5.)

WARNING

Do not plug the power cord into an outlet which is not grounded, or adapt the plug to connect to a receptacle for which it is not designed.

Be sure that all three prongs of the supply cord are properly plugged into the receptacle.

Do not connect the power cord to an extension cord.

Do not plug the power cord into the generator receptacle while the generator is already running

Most campgrounds are equipped with a fuse or circuit breaker at the receptacle. This protects the park’s wiring, as well as the power cord on your vehicle, from electrical damage. If electrical power fails, contact the park attendants and have them check the fuse or breaker for your supply receptacle.

After disconnecting the power cord, neatly replace it in the storage compartment.

POWER CENTER

The power converter changes 110-volt AC current from the auxiliary generator or the shore-line into 12-volt DC current for use by 12-volt equipment in the motor home.

Certain circuits, however, remain unchanged for use by items which require 110-volt current, such as the air conditioner(s), the refrigerator in AC mode, the microwave oven, etc.

Current drawn from the coach batteries passes through the power center unchanged, although it is routed through a series of protective fuses located on the power panel.

The power panel is located in a lower cabinet face in the galley, living area. The power panel contains the coach electrical system 110-volt circuit breakers and 12-volt fuses.

110-Volt Circuit Breakers 12-Volt House Fuses

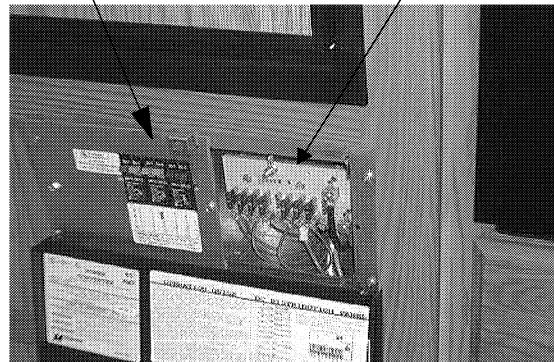

Power Center

WARNING

Do not store anything around or on top of the converter, or in front of the cover. The converter generates heat while operating, and needs unrestricted air flow for proper cooling.

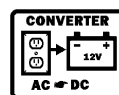

Converter

The converter charges coach batteries while 110-volt external power is connected. The converter will automatically “sense” the condition of

the RV battery. If it is below “full charge”, the Charging Section will start charging the battery.

If the coach batteries have been extremely discharged, they will accept charge at a relatively high amperage rate. If they are only slightly discharged, they will charge at a lower amperage rate. The rate of charge will decrease as the batteries reach “full charge”. Active charging will not resume until batteries again fall below “full charge”. The converter will not overcharge the batteries. If your storage battery does not charge as described above, it is possible the battery is defective.

Thermal Breaker

A protective thermal breaker will “break” the 110-volt AC power to the converter section of Power Center if the power converter becomes overheated. This can result from operating above its maximum limit for an extended period of time or by obstruction of ventilation to unit.

NOTE: Power converter section will automatically route 12-volt lights and motors to battery power in this event.

The thermal breaker will reset itself after a period of time, and the lights and motors will again resume operation from power converter section. If the breaker trips again shortly after reset, take immediate steps to correct cause of overheating. A portion of RV 12-volt load (lights or motors or both) should be turned off to reduce total load. Also, inspect power converter section to make sure ventilation is not obstructed.

NOTE: The converter will not change 12-volt DC current to 110-volt AC.

110-VOLT CIRCUIT BREAKERS

The breaker panel protects all 110-volt components in the motor home from either an overload on the circuit or a short in the wiring or component itself. When an overload or short develops, the breaker will open preventing any further flow of electricity and, therefore, damage to the system.

Shut off the equipment (example: roof air conditioner) and allow a brief cooling period. Then reset the breaker by moving the switch to “Off” and back to “On”. If the breaker is continually tripped and no overload is evident, have the system checked for a short in the wiring or the appliances.

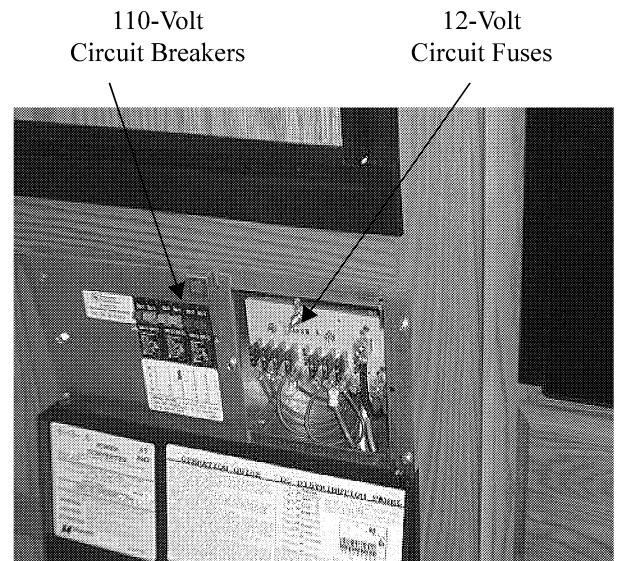

Power Center

Further Information

Refer to the converter manufacturer’s information provided in your Owner InfoCase for additional information about your power converter system.

110-VOLT RECEPTACLES (Outlets)

A number of standard AC electrical outlets are provided throughout the coach for connecting small appliances such as televisions, radios, toasters, etc. Outlets are also located on the outside of the coach near the entrance door.



GROUND FAULT CIRCUIT INTERRUPTER

Exterior, bath and galley outlets are connected to a GFCI (Ground Fault Circuit Interrupter), which is an extremely sensitive circuit breaker that will help to protect against severe electrical shock if a ground fault develops. If such a condition occurs, the GFCI will break the circuit by



turning off the power to the protected outlets. Should this occur, unplug all the appliances on that circuit and press the reset button on the GFCI equipped outlet.

If the GFCI keeps tripping, have the electrical system checked and repaired if necessary before using again.

The GFCI outlet is located in the bath, bedroom or dinette area, depending on the floor plan of the vehicle.

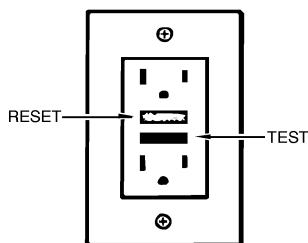

WARNING

The GFCI will not completely eliminate electrical shock. Small children and persons with heart conditions or other disabilities which make them especially sensitive to electrical shock may still be injured by a 110-volt receptacles even though protected by a Ground Fault interrupter.

NOTE: In compliance with CSA electrical codes, the appliance outlet in Canadian equipped coaches is not connected to a GFCI protected circuit.

WARNING

Careless handling of the generator and electrical components can be fatal.

Never touch electrical leads or appliances when your hands are wet, or when standing in water or on wet ground.

Do not attempt to repair the generator yourself. Service should be performed by an authorized service center.

Do not plug the power cord into the generator receptacle while the generator is running.

To use the 110-volt generator, plug the power cord into the generator receptacle within the shoreline compartment before starting the generator.

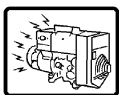
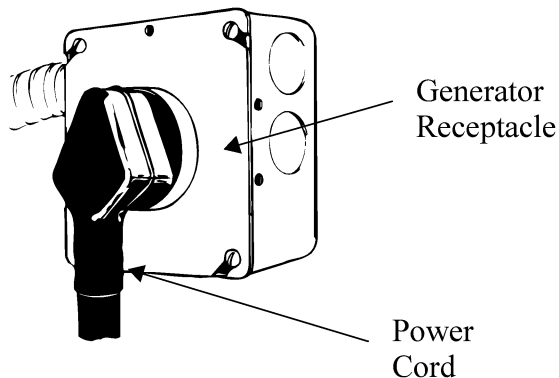

AUXILIARY 110-VOLT GENERATOR
Optional

Consult the information provided in your Owner InfoCase for instructions on operation, troubleshooting and maintenance.

STARTING AND STOPPING THE GENERATOR

The generator switch is located on the range hood. The generator starter circuit does not rely on the automotive battery, so the switch will operate whether the ignition switch is on or off.

This coach may be equipped with one of several models of generators. Consult the generator owner's manual in your Owner InfoCase for specific instructions on starting and stopping your generator.

Generator Switch
and Hourmeter

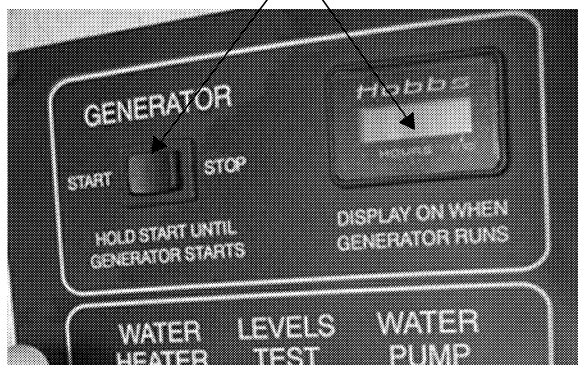

Basic Generator Operation: Starting:

- See generator manufacturer's operating information for specific instructions.
- Reduce all electrical loads. (Shut off lights, fans, appliances, etc.)
- If the generator has not been run for two weeks or more, you may need to prime the fuel system before attempting to start.
- Press the generator starter switch on and hold until generator engine is running, then release.
- Let the generator engine stabilize and run smoothly before turning appliances or electrical equipment on.
- Refer to the output specifications of your generator in the generator manufacturer's manual.
- Do not overload generator by turning too many items on. See load chart for estimation of typical RV loads.

Stopping:

- Before shutting generator down, turn off electrical loads and let engine run at no-load for a few minutes to cool down.

- Press the generator switch Off and hold until the generator engine comes to a complete stop.

CAUTION

Continuous generator overloading can cause high operating temperatures that can damage the generator windings. Keep the electrical loads within the generator wattage rating.

Approximate Power Requirements of Common Appliances

Appliance or Tool	Approximate Power Consumption (Watts/Amps)
Vacuum cleaner	200-500W/1.7-4.3A
Coffee Maker	550-700W/4.8-6.1A
Hair dryer	800-1500W/7.0-13.0A
Electric clothes iron	500-1200W/4.3-10.4A
Electric blanket	50-200W/0.4-1.7A
Television	80-100W/0.7A
Electric drill	250-750W/2.2-6.5A
Air conditioner	1400-2000W/13-19A
Converter	300-500W/2.6-4.3A
Microwave Oven	700-1500W/6.0-13.0A

GENERATOR HOURMETER (If Equipped)

This meter is located on the monitor panel. It registers the total number of hours that the generator has been operated. Refer to the hourmeter to determine when periodic maintenance is due and to record services which have been performed.



**GENERATOR OPERATION
WARNINGS AND CAUTIONS**

WARNING

The exhaust of all internal combustion engines contains carbon monoxide (CO). This poisonous gas is colorless, odorless, tasteless, and lighter than air. The exhaust systems of both your motor home engine and your generator engine have been installed with your safety in mind. However, certain precautions must be taken when using them to protect yourself from conditions beyond the control of the manufacturer.

1. **Do not** simultaneously operate the generator engine and a ventilator which could draw exhaust gases into the vehicle.
2. **Do not** open windows or ventilators on the end or side of the vehicle where exhaust pipe of the generator is located.
3. **Park the vehicle** so that the wind will carry the exhaust away from the vehicle. Also, note the position of other vehicles to be sure their exhaust will not enter your vehicle.
4. **Do not** operate the generator engine when parked if vegetation, snow, buildings, vehicles, or any other object can deflect the exhaust under or into the vehicle.

Check auxiliary generator oil level frequently during periods of use. Refer to the generator manufacturer's information in your Owner Info-Case for specific recommendations.

WARNING

Never check generator oil level while generator engine is running.

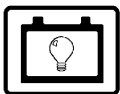

12-VOLT DC SYSTEM

The DC voltage system consists of the automotive battery and the 12-volt motor home auxiliary batteries.

Automotive (Starting) Battery

The chassis battery is used solely to operate the engine starter and all automotive accessories and controls found on the instrument panel. This includes the horn, speed control, all exterior lights, radio, windshield wipers, rear auto heater fan, etc.

House Batteries

The house batteries supply current to all 12-volt equipment located in the living area of the motor home. This includes interior lights, range exhaust fan, furnace fan, water pump, water level and holding tank gauges, 110-volt generator starting, refrigerator, bath roof vent fan, and the rear automotive heater. The house battery may also be used to start the engine if the chassis battery is dead. Refer to "Aux. Start Switch."

The house batteries are "deep-cycle" type batteries specially designed for recreational vehicle use. They will provide longer lasting power than standard automotive batteries, and will withstand the frequent drain-and-recharge cycles that occur under the demanding conditions of a camping outing.

The house batteries are automatically charged by the engine alternator while the engine is running.

12-VOLT HOUSE FUSES AND CIRCUIT BREAKERS

All 12-volt circuits and equipment in the coach area of the motor home are protected by either a fuse panel or breaker panel. When a circuit is overloaded or a short develops in any part of the system, a fuse or breaker will shut down that circuit. If this happens, turn off all affected lights or appliances and reset the breaker or replace the fuse with a new one of equal amperage rating.

A label on the panel states the amperage rating and circuit protected for each fuse or breaker.

FUSE OR CIRCUIT BREAKER PANEL

The fuse or breaker panel is mounted on the right-hand side of the power converter.

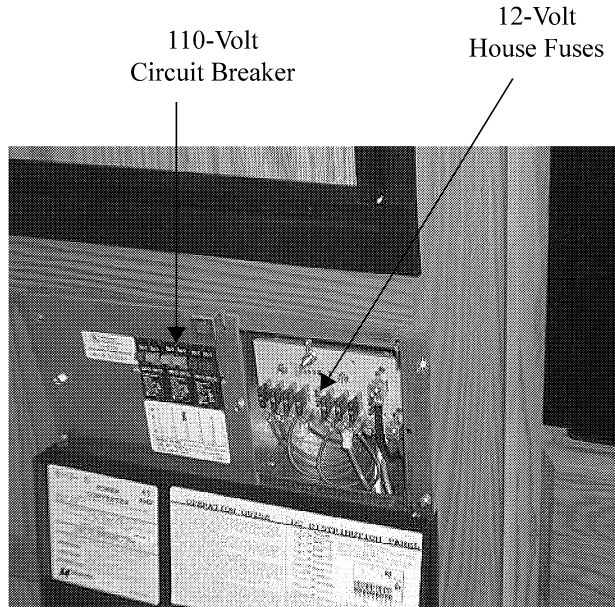

Power Center

The fuse panel accepts only blade type plug-in fuses. Always replace fuses with those of the same amperage rating.

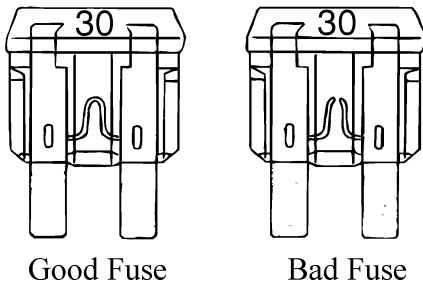

Good Fuse

Bad Fuse

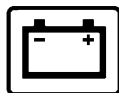

BATTERY INFORMATION

CHASSIS BATTERY ACCESS

The automotive (starting) battery is located in the engine compartment.

AUXILIARY (HOUSE) BATTERY ACCESS

The house battery is located in the battery storage compartment beneath the inside entrance steps for convenient access for periodic inspection or maintenance.

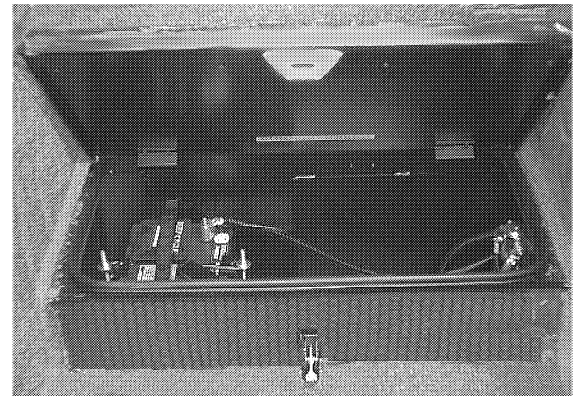

House Battery in Top Entrance Step

To service or remove the batteries, unfasten the retainer strap and disconnect battery cables.

WARNING

Refasten the retainer strap when returning the battery to the compartment.



BATTERY STORAGE AND MAINTENANCE

Lead-acid type batteries are electro-chemical devices for storing and releasing electrical charge. As such, they are simply an electrical reservoir, not an electrical source. As soon as energy is removed from the battery, it should be replaced by the engine alternator or the RV converter system.

If a battery sits unused for 30 days or more, especially during warm weather, it can develop a deposit of sulfate crystals on the metal plates inside the battery. This condition is called sulfation or sulfating, and prevents the battery from either releasing or accepting a charge. If this condition occurs, the battery must be replaced.

If a battery does not contain at least 80% charge during freezing temperatures, the electrolyte can freeze and crack the battery case.

The two best defenses against sulfating and insufficient charge are to:



1. turn off the Auxiliary Battery switch to avoid *parasitic discharge* (the trickle discharge caused by directly connected components like LP gas detectors or digital clock displays, etc.) and
2. check the battery and recharge as necessary at least once a month during long storage periods.

WARNING

California Proposition 65 Warning: Battery posts, terminals and related accessories contain lead and lead compounds, chemicals known to the state of California to cause cancer and reproductive harm. Wash hands after handling.

Further precautions are:

- Remove the battery from the coach.
- Store it in a cool place on a wooden or rubber pad to inhibit conductive transfer.
- Check the state of charge periodically to avoid discharge or sulfating.

To ensure that the battery will always accept and hold a charge, follow these simple maintenance practices.

- Make sure the batteries always remain securely clamped in the battery tray.
- Make sure battery cable clamps are tight on the terminal posts and are free of corrosion.
- Neutralize corrosion buildup or acid film on top of battery by washing with a baking soda/water solution. Rinse with clear water.

NOTE: Make sure vent caps are on securely to prevent baking soda solution from entering the battery and contaminating the electrolyte fluid.

WARNING

Before removing any battery cables or battery, make sure all 12-volt equipment in the motor home is off and the power cord has been disconnected.

Replace any damaged cables at once.

Always remove jewelry and wear protective clothing and eye covering when checking or handling batteries

Refasten the retainer strap when returning the battery to the compartment.

- Clean and tighten battery terminals and have the specific gravity checked at least once a year.
- Every two months, or more often in hot weather, check the battery fluid level. Fill to approximately 3/8 inch above the plates. **DO NOT OVERFILL.** If fluid is added during freezing weather, the motor home should be driven several miles to mix water and electrolyte to prevent freezing.
- Fluid level check may be omitted if equipped with maintenance-free batteries.

WARNING

To prevent damage to batteries or wiring, always observe battery polarity. Always attach positive (+) cable to positive terminal and negative (-) cable to negative terminal. The battery terminals are marked (+) and negative (-).

Disconnect both battery cables before connecting a “booster” battery charge to a battery inside the battery compartment.

Never try to charge or boost a frozen battery. A battery explosion could result.



BATTERY CONDITION METER

This meter allows you to check the level of charge in the house battery in your motor home. It is located on the monitor panel in the galley area. (See Section 8.)

To obtain an accurate reading:

1. Both the automotive engine and the auxiliary generator engine must be stopped.
2. An interior light should be turned on to provide a small load which draws off battery surface charge.

AUX. START SWITCH - See page 2-8.

TRAILER WIRING CONNECTOR

Your coach is pre-wired for trailer or car towing lights with a 6-pin socket on the rear bumper. The connector plug is supplied in the coach parts package provided to you by your dealer when you took delivery of the vehicle.

The diagram shows proper connection of trailer or tow vehicle wiring to the coach light system. Remove the small screw near the end of the plug and slide the contact assembly out of the barrel.

TM = Tail lights
GD = Ground
LT = Left Turn
RT = Right Turn
S = Brake lights
A = Backup lights

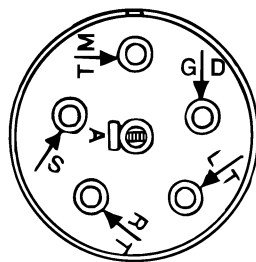



FRESH WATER SYSTEM

The fresh water system provides water to the galley sink, shower, bathroom lavatory, toilet and water heater. Water may be supplied by either of two sources:

- a water tank located within the motor home, or
- any external water source to which the motor home may be connected, known as “city water”.

FILLING THE FRESH WATER TANK:

Always fill the fresh water tank at an approved potable water filling facility or a known purified drinking water source.

The tank may be filled by inserting a hose into the tank fill opening. A built-in vent prevents the tank from becoming air-locked while filling.

When neither city water nor a hydrant are available, a bucket and funnel may be used to fill the tank, but this can take a considerable amount of time.

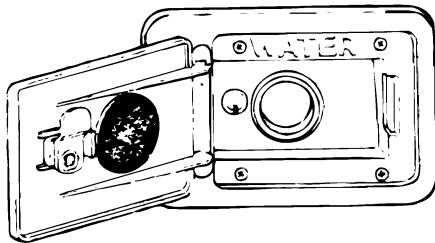

WATER TANK FILL



Fresh Water Tank Capacity

Model 429U	31 gal.
Models 430V & 431C.....	35 gal.



WATER PUMP

Pressure for the water system is supplied by a water system demand pump which is fully automatic after initial priming. When a faucet is opened, the pump begins operation to provide a constant flow from the tank. When the faucet is closed, the pump automatically shuts off.

WATER PUMP SWITCH

The water pump switch is located on the water/holding tank monitor panel (See Section 8). While the switch is in the “ON” position, the pump will automatically supply water pressure as it is needed. It is recommended that the pump switch be turned off whenever you are away from the vehicle or not using the water system. A slow leak in a faucet could drain the water system and discharge the house battery.

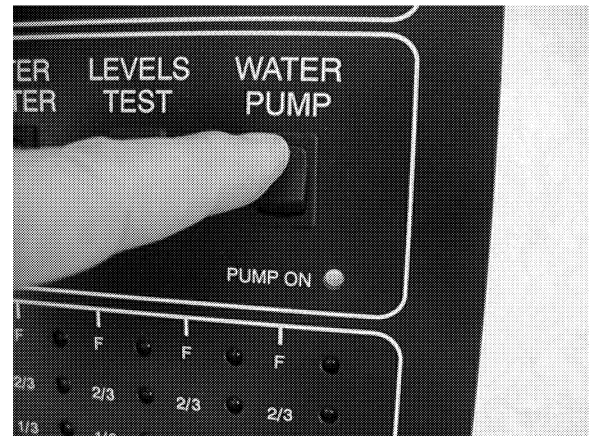

INITIAL START-UP

1. Make sure that all water drain valves are closed, including water heater valve. (Refer to Section 10.)
2. Turn water pump switch to “OFF” position.
3. Fill water tank.
4. Open all faucets, hot and cold.
5. Turn on pump switch.
6. Close each faucet as it begins to deliver a steady stream of water (close cold water first). Leave hot water faucets on until they



also deliver a steady stream of water. This will ensure that the water heater is filled with water.

7. Check to be sure pump stops soon after all faucets have been closed.
8. Pump is now ready for automatic operation. Pump will start when a faucet is opened and stop when the faucet is closed.

DISINFECTING FRESH WATER SYSTEMS ON RECREATION VEHICLES

(As approved by the U.S. Public Health Service)

To assure complete disinfection of your fresh water system, it is recommended that the following procedure be followed on a new system, one that has not been used for a period of time, or one that may have become contaminated. This procedure is also recommended before long periods of storage such as over winter.

1. Prepare a chlorine solution using 1 gallon of water and 1/4 cup of household bleach (sodium hypochlorite solution). With tank empty, pour chlorine solution into the tank. Use 1 gallon solution for each 15 gallons of tank capacity. This procedure will result in a residual chlorine concentration of 50 ppm in the water system. If a 100 ppm concentration is required as discussed in item 3, use 1/2 cup of household bleach with 1 gallon of water to prepare the chlorine solution. One gallon of the solution should be used for each 15 gallons of tank capacity.
2. Complete filling of tank with fresh water. Open each faucet and run the water until a distinct odor of chlorine can be detected in the water discharged. Do not forget the hot water taps.
3. Allow the system to stand at least 4 hours when disinfecting with 50 ppm residual chlorine. If a shorter time period is desired, then a 100 ppm chlorine concentration should be permitted to stand in the system for at least 1 hour.
4. Drain and flush with fresh water.

WARNING

Chlorine is poisonous - recap bottle and clean utensils after use.

Never use automotive type antifreeze in your potable water system as it is poisonous.



EXTERNAL WATER SUPPLY ("City Water")

To connect to an external source:

1. Turn the demand pump switch to off.
2. Attach a hose from the external water source to the city water connection in the utility compartment on the left side of your vehicle.
3. Turn on the external water source.



City Water
Connection

When connected to an outside source of water, the water bypasses the demand pump and storage tank and supplies pressure directly to individual faucets and toilet. A check valve built into the pump prevents water from entering the pump and filling the storage tank.

NOTE: Because the city water pressure varies from location to location, we recommend using an in-line water pressure regulator to prevent damage to any components, connections and seals in your fresh water system.



A water pressure regulator may be obtained from any well stocked RV dealership retail center and some retail discount centers. These devices simply connect in-line between the supply hose and the city water input on the coach.

*We recommend a regulator that controls water pressure to **40 psi maximum**.*

To disconnect from the external source:

1. Turn the external source off.
2. Open a faucet inside the vehicle to relieve line pressure.
3. Disconnect the hose from the coach.
4. Stick your finger up inside the connection and gently press the backflow valve upward to drain any water left in the line
5. Replace the protective plug back into the threaded collar on the connection.

SHOWER VALVE PRESSURE BLEED-OFF

After using the shower, you may notice water dripping from the shower faucet assembly. The dripping results when vacuum in the shower hose (after closing the shower faucet) slowly releases and allows water remaining in the hose to drain down. This is a normal function of the shower valve assembly and is not a leak or defect.

The International Association of Plumbing and Mechanical Officials Standard TSC 21-85 (PAR. 4.3) states:

“Shower heads which incorporate shutoff valves, shall have a minimum “drip rate” of one (1) quart in thirty (30) minutes.”

CAUTION

If items are placed into the shower tub before shower valve vacuum release is complete, they may become wet.



EXTERIOR SHOWER

The exterior auxiliary shower feature allows you to do things such as rinse off sand or salt

after a swim, rinse off muddy boots, or bath your pet outside the coach.

The shower is located in the utility system compartment on the left side of the coach, just ahead of the rear wheels.

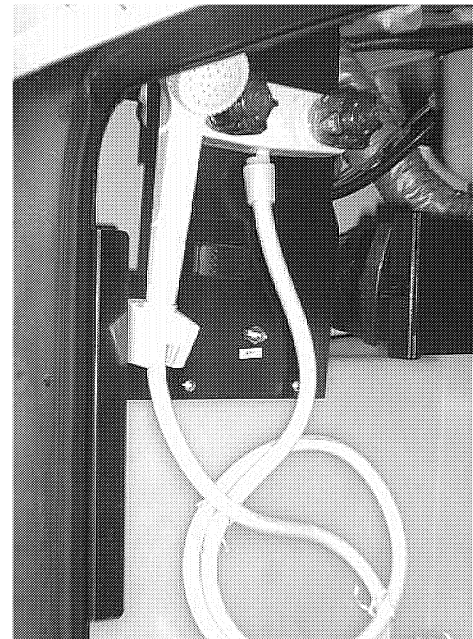

**WASTE WATER SYSTEM
(HOLDING TANKS)**

The drainage system is self-contained and uses two separate holding tanks to contain the waste water until it can be dumped at an appropriate waste water disposal site. This means you can use the toilet, sinks and shower even in areas where utility hookups are not available.

The main holding tank contains the sewage from the toilet, and is commonly called the *black water* tank. The second holding tank contains the waste water from the galley sink, bathroom lavatory and shower, and is commonly called the *gray water* tank.

The holding tanks are dumped through a common outlet located on the left side of the vehicle, near the rear wheels.



DUMPING HOLDING TANKS

1. Remove drain hose from rear bumper or exterior storage compartment.
2. Remove dust cap from drain and connect drain hose. Be sure it is firmly attached.
3. Place the other end of sewer hose into disposal opening.
4. Open the (large) sewage valve with a quick pull. **OPEN ONE VALVE AT A TIME.** Move hose gently about to dislodge any waste and to ensure complete drainage.

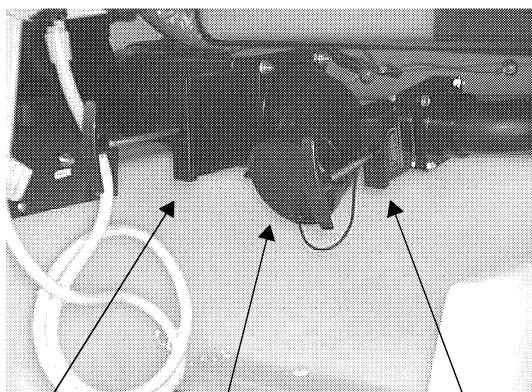

Black Water Tank Valve Sewer Hose Outlet Gray Water Tank Valve

5. Close sewage valve and open (small) waste water valve with a quick pull. Make sure there are no sags in the hose during drainage. Close valve handle as soon as tank is empty.
6. After both tanks have been drained, run several gallons of water into the sewage tank through the toilet. Then open sewage dump valve and drain the tank again. Close valve and replace dust cap securely.
7. It is advisable to add an odor control chemical to the sewage holding tank. These chemicals are available at most R.V. stores.
8. Rinse sewer hose thoroughly with water and stow.

NOTE: We recommend that you dump all holding tanks before traveling to avoid carrying unnecessary weight.

USING ON-SITE SEWER HOOK-UPS

The drain hose may remain attached to the dump outlet and be routed out the bottom of the compartment while the motor home is parked and connected to an on-site sewage hook-up.

When using a sewer hook-up, keep the dump valves closed until a tank becomes full or when preparing to leave the site. This keeps the solids in suspension, allowing them to be carried out with the liquids when the dump valve is opened. If the valve is left open, the liquids will drain off, leaving solids in the tank. Should this accidentally happen, disconnect the hose, fill the tank about half full with water, and drive a few miles to dislodge the solids. A few starts and stops will aid in the process. Then reconnect the hose and drain in the normal manner.

HOLDING TANK LEVEL INDICATORS

The holding tanks may be monitored on the wall mounted monitor center.

Press the “Levels Test” switch to check the level in each tank.

See Section 8 - Appliances for further information on the monitor panel.

WATER DRAIN VALVES

The water drain valves are used to drain water from the water tank and the water supply lines when preparing the motor home for storage or when sanitizing the water system.

To open or close the drain valves, turn the handles in the directions indicated by the following illustration.

Drain valve locations are listed on the following pages.

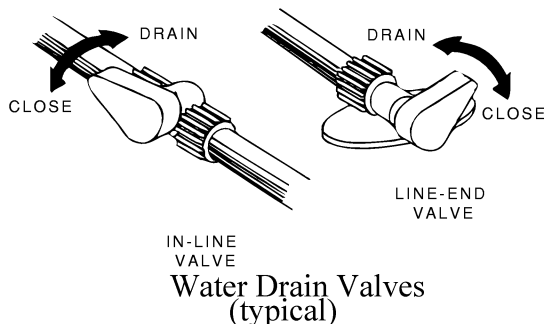

IN-LINE VALVE LINE-END VALVE
Water Drain Valves (typical)



Water System Winterization Valve

Your coach is equipped with a manually operated water line winterization system for your convenience in winterizing fresh water lines.

The system features a diverter valve and suction tube in-line between the tank and water pump to draw non-toxic RV water system antifreeze into the water lines. This feature is located near the water pump and drain valves. See page 7-6 for location in your coach.

1. Place end of suction tube in jug of RV antifreeze.

2. Move water heater bypass switch to bypass position..

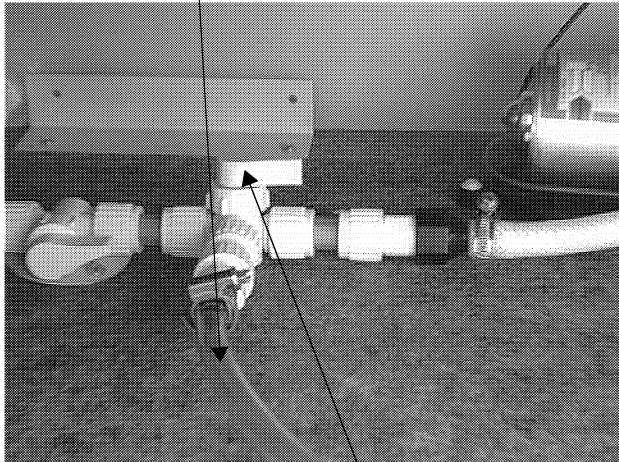

3. Turn diverter valve handle toward suction tube.

To Fill Lines with RV Water Line Antifreeze

- Turn water heater by-pass valve to BY-PASS position.
- Remove and save the protective cap from the end of the suction tube.
- Insert the end of the tube into a container of RV antifreeze solution.
- Turn the diverter valve handle so that it points toward the suction tube.
- Turn a water pump switch on.
- Open each cold water faucet handle in the coach one at a time until antifreeze solution just begins to flow from the faucet, then close.

When Done Adding RV Antifreeze:

- Turn water pump switch off.
- Turn the diverter valve handle so it points toward the water line to the pump as shown in the photo. This will stop the flow from the suction tube and revert the tank line flow to the pump.
- Replace the protective cap onto the end of the suction tube to keep out insects and debris when not in use.

CAUTION

Leave by-pass valve handle in NORMAL FLOW position if draining water and blowing out water lines. Place in BYPASS position ONLY when using antifreeze solution in water lines.



TANK CAPACITIES



HT1 - Black Water Holding Tank

Model 429U (Toilet & Lavatory).....	34 gal.
Model 430V (Toilet & Lavatory).....	35 gal.
Model 431C (Toilet & Lavatory).....	36 gal.



HT2 - Gray Water Holding Tank

Model 429U (Galley & Shower).....	31 gal.
Model 430V (Galley & Shower).....	38 gal.
Model 431C (Galley & Shower).....	38 gal.

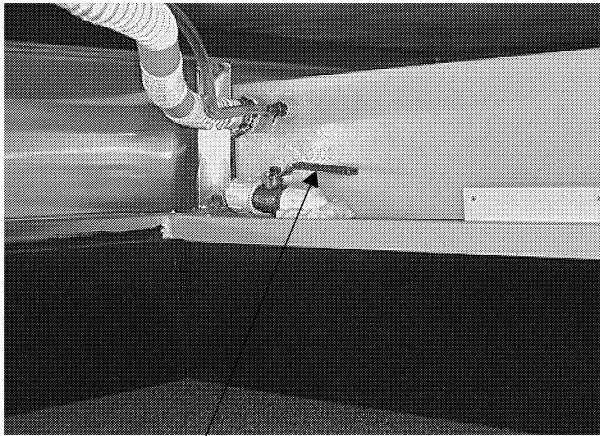

Water Tank Drain Valve

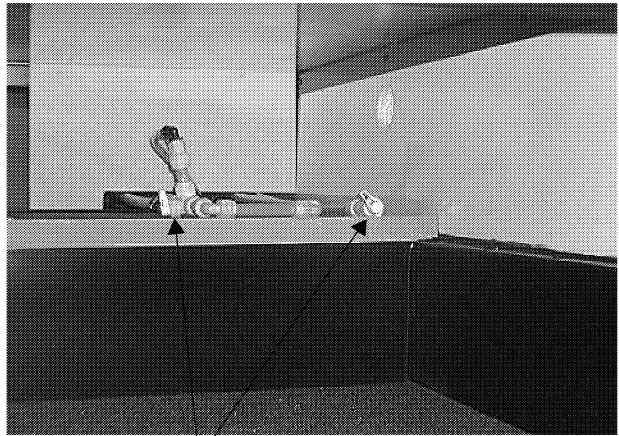

Water Line Drain Valves



WATER SYSTEM DRAIN VALVE LOCATIONS		
MODEL	SYSTEM	DRAIN VALVE LOCATIONS
429U	Water Lines:	One (1) valve in passenger side rear cargo compartment. Also open exterior shower faucet (in water center) and place shower head below floorline.
	City Water Line:	The city water hose connection is located on the “ceiling” of the Utility System compartment. Stick your finger up inside the connection and gently press the backflow valve upward to drain any water left in the line.
	Water Tank:	One (1) valve in passenger side rear cargo compartment.
	Water Heater:	Drain plug on outside of coach, behind service door. Use socket to remove drain plug.
	Water Heater By-Pass Valve:	Behind access panel beneath galley cabinet.
	Winterization (Antifreeze) Valve:	In passenger side rear cargo compartment.
430V	Water Lines:	Two (2) valves in cargo compartment just behind rear dual wheels on driver side of coach.
	Water Tank:	One (1) valve in cargo compartment just behind rear dual wheels on driver side of coach.
	Exterior Shower:	Open exterior shower faucet knobs and place shower head below floorline of coach to drain hose and water line.
	Water Heater:	Drain plug on outside of coach, behind service door. Use socket to remove drain plug.
	Water Heater By-Pass Valve:	Behind access panel beneath galley cabinet. (See photo on pg. 7-8)
	Winterization (Antifreeze) Valve:	In cargo compartment just behind rear dual wheels on driver side of coach.



431C	Water Lines:	One (1) valve in passenger side rear cargo compartment. Two (2) valves (1 hot/1 cold) on floor beneath lavatory cabinet. Also open exterior shower faucet and place shower head below floorline.
	City Water Line:	The city water hose connection is located on the “ceiling” of the Utility System compartment. Stick your finger up inside the connection and gently press the backflow valve upward to drain any water left in the line.
	Water Tank:	One (1) valve in passenger side rear cargo compartment.
	Water Heater:	Drain plug on outside of coach, behind service door. Use socket to remove drain plug.
	Water Heater By-Pass Valve:	Behind access panel on lower face/refrigerator cabinet.
	Winterization (Antifreeze) Valve:	In passenger side rear cargo compartment.



(See also Safety Precautions, Section 1 of this manual.)

NOTE: Because this model is available in several sizes and floor plans, some items described may be optional or unavailable on your coach.

The appliances installed in your motor home are manufactured by reputable RV appliance makers and have been tested by independent laboratories to meet all applicable standards and codes set for RV appliances. These appliances are covered by your New Vehicle Limited Warranty. (Certain items may be covered by individual manufacturer's warranty.) See your New Vehicle Limited Warranty for details.

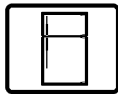

REFRIGERATOR

The refrigerator in your coach can be operated from either of two power sources available to the motor home:

- 110-Volt AC electric
- LP gas

The refrigerator is an absorption type which uses an ammonia-water solution for cooling. Basically, ammonia vapor is distilled from the solution by heat, produced from either LP gas or electricity and then carried to the finned condenser where it liquefies. The liquid then flows to an evaporator where it creates cold temperatures through evaporation.

LEVELING

Before operating the refrigerator when the motor home is stationary, place a small level on the freezer plate and make certain the unit is level.

CAUTION

To prevent permanent damage to the refrigerator cooling unit, turn the refrigerator off if the vehicle will be parked on an incline of over 3° side-to-side or 6° front-to-rear (such as steep driveways or parking lots, etc.) for more than one hour.

Normal vehicle leveling to provide comfort for the occupants is satisfactory for refrigerator operation. This will be well within the operation limits of 3° off-level side-to-side and 6° off-level front-to-back.

OPERATING INSTRUCTIONS

Norcold Model 900-Series Models with Electronic Auto Mode Control



Push door handle downward and pull to open refrigerator.

Lift freezer door handle to open.

Start-Up Instructions - Gas Mode

The control panel is located between the freezer compartment and fresh food compartment. It contains pressure sensitive touch switches and LED display. The AC, LP GAS, Battery, and AUTO LED's (A) illuminate to indicate the refrigerator's operating mode.

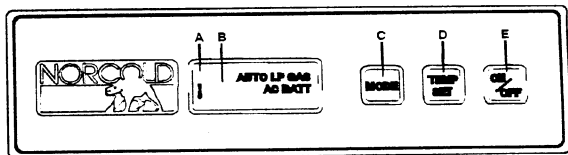
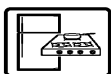

The ON/OFF button (E) turns the refrigerator On or Off. If the button is pressed, it will turn the refrigerator On and set the mode to AUTO. When the refrigerator is On, pressing this button for 2 seconds will turn the refrigerator Off.

Pressing and holding the MODE button (C) allows the user to cycle through the three mode choices; one AUTO and two manual modes (AC, LP GAS). The refrigerator will not switch to the new operating mode until the mode button is released.

The TEMP SET (thermostat) button (D) controls the refrigerator and freezer temperature during both gas and electric operation. Press and hold the TEMP SET button to select the desired temperature setting. The temperature settings are shown in the form of LED's (A). The illuminated LED indicates the temperature setting, with COLD on the left and COLDEST on the right. The temperature LED turns off after 10 seconds. Quickly press and release any button to display the temperature setting.

Start-Up Instructions - Auto Mode

When the AUTO mode is selected, the operating control automatically selects the power source using the following priority scheme:

- When 120 volts AC is available to the refrigerator, the AUTO LED and the AC LED will illuminate, indicating the refrigerator is operating on AC electric. After 10 seconds, the AC LED will turn off and only the AUTO LED will remain illuminated. Press and quickly release any button to display the operating mode.
- If 120 volts AC is not available, the refrigerator will switch to the gas operation. The AUTO LED and the LP GAS LED will illuminate. After 10 seconds, the LP GAS LED

will turn off and only the AUTO LED will remain illuminated. Press and quickly release any button to display the operating mode.

During operation in the AUTO mode, when a higher priority power source becomes available, the operating controls will cease using the current power source and will switch to the higher priority power source. For example, if AC electric becomes available while the refrigerator is operating in the AUTO LP GAS mode, the refrigerator will switch to AUTO AC operation.

If an operating mode is not functional, its corresponding LED will flash and the refrigerator will attempt to operate in a lower power priority source. If a lower power priority source is not available, the LED will continue to flash, and the refrigerator will cease operation until the energy source is corrected. Refer to the "Diagnostic" section on page 7 of the "Norcold 9100 Series Refrigerators Operator's Guide" in your InfoCase.

Start-Up Instructions - Manual Mode

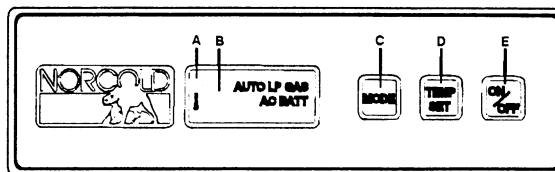

To operate the MANUAL mode, press and hold the MODE button (C) until the AUTO LED disappears and the desired operating mode is displayed. If the power source is interrupted while operating in the MANUAL mode, the AUTO LED disappears and the desired operating mode is illuminated. Unlike AUTO mode, the operating mode LED remains illuminated until an alternate mode is selected. If the energy source is interrupted while in the MANUAL mode, the corresponding LED flashes, and the refrigerator ceases operation until an alternative energy source is selected or the problem is cor-

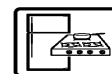

rected. Refer to the “Diagnostics” section on page 7 of the Norcold Operator’s Guide in your blue binder for corrective actions.

AUTO and MANUAL Modes - Gas Operation Only

If the gas does not ignite within 30 seconds, which may occur on initial start-up, the refrigerator’s gas valve will automatically close and the operating controls will select an alternate power source (AUTO Mode) or revert to a stand-by mode in which the LP GAS LED flashes. The LED continues to flash until the refrigerator is turned OFF and then ON. If the gas does not ignite after several attempts, check the input gas supply, or consult with your dealer or a Norcold authorized service center. A different mode of operation may be selected by pressing and holding the MODE button. The refrigerator will not switch to the new operating mode until the MODE button is released.

Backup Operating System (“BOS”)

Your refrigerator features a Backup Operating System which keeps the refrigerator cool in the event of a failure of the refrigerator’s operating controls. If a failure occurs, the TEMP SET LED flashes and refrigerator switches to the BOS mode. This mode provides refrigeration until the refrigerator is serviced. The fresh food and freezer compartment temperatures should be monitored to prevent over-freezing or thawing of refrigerator contents when operating in the BOS mode. If the refrigerator temperature is too cold, adjust the thermostat to the left in single LED increments. If the refrigerator temperature is too warm, adjust the thermostat to the right in single LED increments. Let the refrigerator operate at the new setting for one hour before rechecking the freezer and fresh food compartment temperatures. (Frequent door opening prevents the temperatures from stabilizing.) Although the refrigerator can operate in this mode, Norcold recommends that you seek service to restore manual operation as soon as practical.

HUMIDITY - STORAGE SWITCH

Turning this switch to HIGH HUMIDITY will keep the surface between the door openings dry during high humidity conditions. The switch should be left in the NORMAL OPERATION position unless moisture collects around the door.

When storing your RV for the winter, place this switch in the STORAGE (LIGHT OFF) position. This shuts off all DC power to the light and humidity heater and allows the refrigerator door to be left open for airing without draining the battery.

Operating Tips

- The refrigerator should already be cold before placing items in it.
- Food and beverages should also be cold before placing in RV refrigerator. Never put warm or hot items in a cold refrigerator.
- Do not pack the refrigerator too full. The refrigerator needs room for cold air to circulate.
- Use smaller containers for each item. (e.g. a half gallon container of milk instead of a half-full gallon jug)
- Always put foods, especially liquids, in tightly sealed containers.
- Use crumpled paper between loose items to reduce rattling or “clinking” noises.

Further Information

For further information and operating cautions, see the Norcold refrigerator operating instructions included either inside the refrigerator or in your Owner InfoCase.

REFRIGERATOR COMPARTMENT (Exterior)

The exterior refrigerator compartment allows access to the rear of the refrigerator for inspection, maintenance and service.

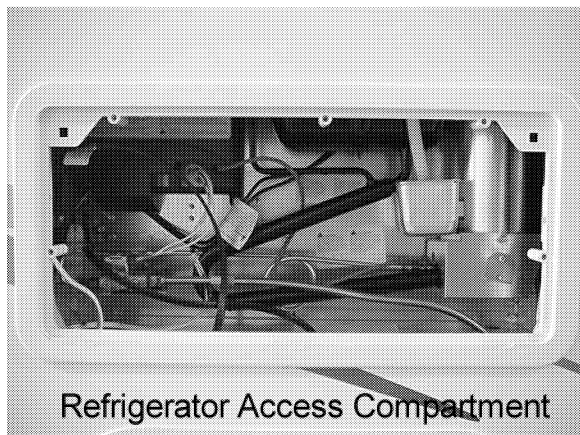
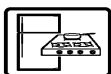

Refrigerator Access Compartment

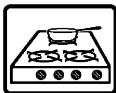

RANGE AND OVEN



To Open:

1. Use a coin to turn the latch knobs to the vertical position as shown.
2. Remove the door from the opening.

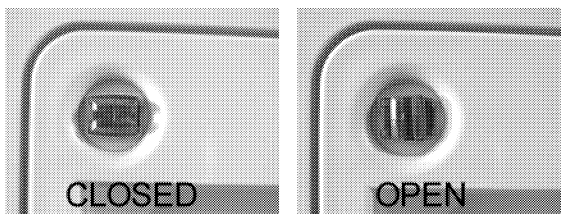

To Close:

1. Replace the door into the opening.
2. Push the latch knobs in while turning to the horizontal position as shown.

The range and oven in your motor home are operated on LP gas and will provide nearly all of the functions that the range in your home does. One benefit of gas burners is that heat is available as soon as a burner is lit, as opposed to an electric element slowly heating up. The range has a “Pilot Off” position on the oven control which allows the oven pilot to be turned off when traveling or refilling the LP tank.

The following warning label has been located in the cooking area to remind you to provide an adequate supply of fresh air for combustion.



Unlike large homes, the oxygen supply inside a recreational vehicle is limited due to its size. To avoid danger of asphyxiation, provide proper ventilation when using the gas rangetop or gas oven. It is especially important not to use the gas oven and range top for comfort heating. Danger of asphyxiation is greater when these appliances are used for long periods of time.

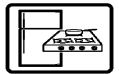

WARNING

Portable fuel-burning equipment including wood and charcoal grills and stoves, should not be used inside the recreational vehicle. The use of this equipment inside the recreational vehicle may cause fires or asphyxiation.

Using Range Top Burners

1. Rotate the Top Burner Ignitor knob clockwise (in the direction of the LITE arrows) to provide ignition spark.
2. While rotating the Ignitor knob, turn the desired Burner Knob to the LITE position.
3. When the burner lights, release the Ignitor knob and turn the Burner knob to the desired flame height.

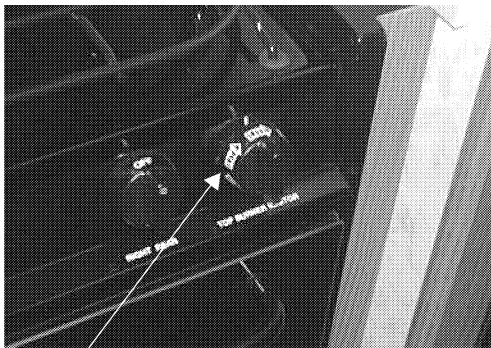

Rotate Ignitor Knob while Burner Knob is in LITE position.

WARNING

Do not turn burner control knob to "On" and allow gas to escape before lighting match.

Lighting Oven Pilot

NOTE: If range has not been operated for a long period of time, a longer waiting period for ignition of the pilot may be necessary due to air in the gas line.

1. Be sure all valves are in the "OFF" Position. The oven control knob should be in "OFF" position.
2. Turn on main gas supply to range.
3. Press and turn control knob to the "PILOT ON" position. This will allow gas to oven pilot.
4. Open oven door and light oven pilot with a match. Small flame will be noted at the

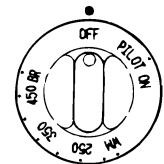

Oven Control Knob in "OFF" position

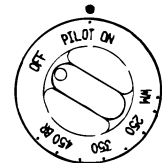

Oven Control Knob in "PILOT ON" position

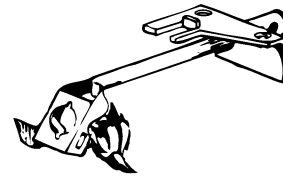

Lighting oven pilot (when pilot is located on left side of burner.)

Operating Oven Control

Push in and turn the oven control knob (counterclockwise) to the desired temperature setting.

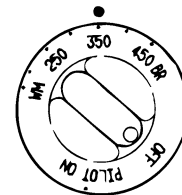

There is a delay of about 45 seconds before the main burner ignites. This is normal and there is no gas escaping during this delay. It is also normal for the oven burner flame to cycle off and on at all temperatures except broil (BR).

Shut Down Instructions

When oven cooking is finished, turn the oven control knob to the "PILOT ON" position, the oven standby pilot will remain lit.

When the recreational vehicle is not in use or while traveling, turn the oven control knob to

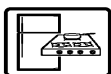

“OFF” position and turn off main gas supply; this will turn off the oven pilot.

MICROWAVE OVEN

For complete operating instructions, refer to the manufacturer’s information provided with the oven.

RANGE HOOD

The range hood vent draws cooking odors and airborne grease particles into the filtration grid and recirculates the air or vents it to the outside of the coach depending on model. A light on the underside of the hood provides better illumination for food preparation. See the manufacturer’s information for instructions on replacement of light bulbs and grease filter elements.

The auxiliary electric generator start/stop switch and hourmeter are located on the range hood panel. See Section 6 for generator starting and stopping instructions and operating precautions.



MONITOR PANEL

The monitor panel provides central location of switches for the hood fan, hood light, water pump and tank level indicator lights.

At the push of a single button this monitor panel simultaneously displays the coach battery condition and levels of the water tank, holding tanks and LP tank. It also contains the water pump power switch and an indicator light to show when the pump switch is on.

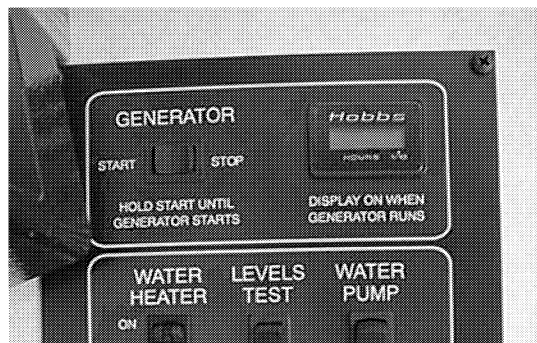
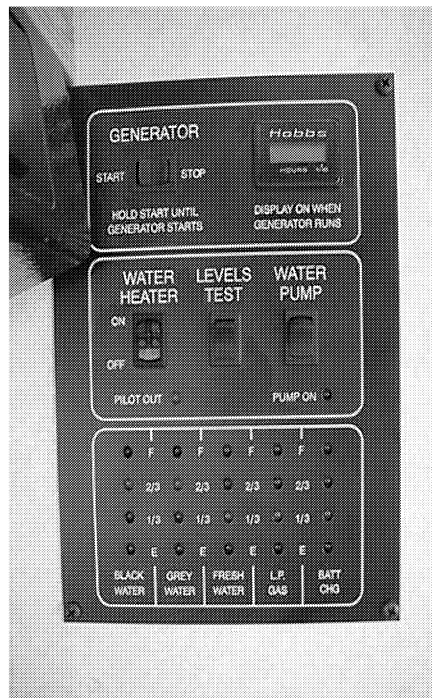

Water Heater Switch

Be sure the water heater is filled with water before pressing this switch. To fill the water heater, turn the water pump switch on and open a hot water faucet until water begins to flow.

On electronic ignition models, the “W.H. Out” light will glow for about 10-15 seconds after the water heater switch is turned on, then it will go off. If the light comes on during normal operation, it means that the burner has gone into “lockout” mode. Turn the switch off for about 5 minutes, then turn back on. See “Water Heater” elsewhere in this section for further information.

Water And Holding Tank Levels

Press and hold the “Levels Test” switch to show approximate level on the monitor lights.

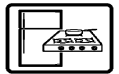

These approximate water levels are measured by electronic probes in the sides of the tanks, so the water must be touching a probe to register at that level. There is generally more water in a tank than indicated on the monitor panel.

For example, if the water level of 1-2" below the FULL probe, the monitor will show the level to be only 2/3 even though the tank is nearly full. If the water level is below the 1/3 probe, the monitor will register an empty tank because the water is no longer touching the 1/3 probe. There may actually be some water left in the tank. However, when the indicator reads FULL, the tank is actually full.



LP Gas Level

Press and hold the “Levels Test” switch to show approximate LP tank level.

The LP level is registered by a sending unit on the tank. The gauge mounted on the side of the tank will give a more accurate indication of actual tank level if needed.

Water Pump Switch

When use of the self-contained water system is desired, turn the “Water Pump” switch on. The “Pump On” light will illuminate when the pump switch is on and the system is operable. Water will be available as soon as a faucet is opened. Refer to “Fresh Water System” for additional information on the water pump and initial start-up.

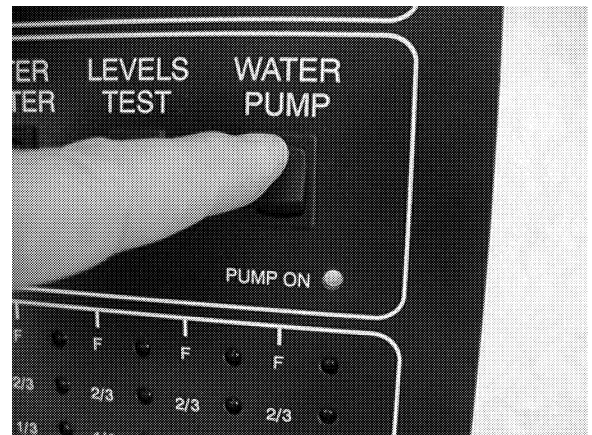

Battery Condition Meter

Push the “Levels Test” button to check the level of charge (voltage) in the 12-volt coach battery. The colored segments (red, yellow and green) will light from the bottom up to the amount of charge the battery contains.

- * Green - good or adequate charge.
- * Yellow - marginal charge.
- * Red - battery needs charging before use.

Water Heater Switch and “W.H. Pilot” Indicator

Be sure the water heater is filled with water before pressing this switch. To fill the water heater, turn the water pump switch on and open a hot water faucet until water begins to flow.

The “W.H. Pilot” light will glow for about 10-15 seconds after the water heater switch is turned on, then it will go off.

If the “W.H. Pilot” light comes on during normal operation, it means that the burner has gone into “lockout” mode. Turn the switch off for about 5 minutes, then turn back on.

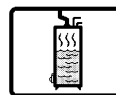

DIRECT IGNITION GAS WATER HEATER - 6 Gallon

1. Place Water Heater switch in the “On” position. The switch and “WH Pilot” light are located on the lower face area of the galley cabinet.

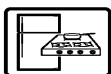

2. If “W.H. Pilot” light stays on longer than 15 seconds, place switch in “Off” position and wait 5 minutes.
3. Repeat step one.
4. If heater fails to operate due to high water temperature, the heater will go into a lockout condition (“W.H. Pilot” light on). When water cools, reset by placing switch in “Off” position for at least 30 seconds, then return to “On” position.
5. If a lockout condition persists: contact your dealer, an Atwood Service Station or Atwood Service Department (Phone: 815-877-5700).
6. For complete shut-down before servicing:
 - a) Place Water Heater switch in “Off” position.
 - b) Remove red wire from left-hand terminal of ECO switch (ECO to valve).

CAUTION

The temperature knob or lever is factory adjusted to its lowest setting. We recommend the mid-point position between warm and hot, as noted above. This will provide for energy efficient operation and sufficiently hot water. Setting at a higher position will produce a higher temperature and increase the risk of being scalded.



GAS/ELECTRIC WATER HEATER - Optional (with Motor Aid water heating system)

Capacity: 10 gal.

The optional 10 gallon gas/electric water heater has a dual power feature. It can operate from LP gas or 110-volt house current; or it can use both at the same time for quicker recovery at times when you are using a lot of hot water.

Read the Atwood Gas Water Heater Installation and Operation Manual for complete Safety Warnings, Operating Instructions and Maintenance Information before operating the water heater.

Be sure the water heater is filled with water before starting either electric or LP operation. To fill the water heater, turn the Water Pump switch on and open a hot water faucet anywhere in the coach. When water begins to flow steadily from the faucet, the water heater is full.

For Electric Operation: Turn on the Water Heater electric element switch. The shoreline must be connected for electric operation.

For LP Gas Operation: Press the Water Heater switch on the Monitor Panel. The “Pilot Out” light will glow for about 10-15 seconds, then it will go out. The “Heater On” indicator will remain lit. If the “Pilot Out” light comes on during LP operation, it means that the burner has gone into “lockout” mode and must be restarted. If this happens, turn the Water Heater switch off for about 5 minutes, then turn it back on. See the Atwood user’s guide in your Owners InfoCase for further information.

For Quick Recovery Operation (Dual): Turn On both Water Heater switches; the gas one on the monitor panel and the electric one. This will help reheat the water heater tank more quickly than a single source would alone. Use this mode when you are using a larger than normal volume of hot water, for example, when someone is taking a shower and the dishwasher or clothes washer is also being used.

Gas Safety Information

- A. This appliance does not have a pilot light. It is equipped with an ignition device that automatically lights the burner. Do Not try to light the burner by hand.
- B. Before lighting, smell around the appliance area for gas. Be sure to smell near floor because LP gas is heavier than air and will settle on the floor.

WHAT TO DO IF YOU SMELL GAS

- Do not try to light any appliance.
- Do not touch any electrical switch.
- Get out of the coach immediately and turn off the LP gas tank at the main tank valve. (See photo on page 5-2.)

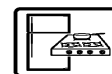

- Use a neighbor's phone to call your Winnebago Industries dealer or a local gas supplier for instructions. Do not use a phone in your coach. Follow the dealer's or gas supplier's instructions.
- If you cannot reach a Winnebago Industries dealer or a local gas supplier, call the fire department.
- Have the source of the leak corrected before using the LP gas system again.

Operating Instructions

1. STOP! Read the safety information provided in the Atwood Water Heater Operation Manual in your Owners InfoCase.
2. Turn off water heater power switches.
3. Turn LP gas supply off.
4. Wait five minutes for any gas to clear the area. If you smell gas, then stop and follow item B of the Safety Information above. If you don't smell gas, go to the next step.
5. Turn on LP gas main tank valve.
6. Turn on the water heater switch on the monitor panel. You may hear a clicking noise as the ignition element begins working. If the burner does not light on first try, the system will stop trying to light burner and go to lockout mode.
7. If lockout happens before main burner lights, turn switch OFF, wait five seconds and turn switch back on. This will restart the ignition cycle. The first start-up of the water heater after it has not been used for a long time may require several ignition cycles before all the air is purged from the gas lines and gas begins to flow.
If the burner will not come on, check the following items before calling for service.

1. Is the switch turned on?
2. Does the LP tank have gas in it or is main tank valve turned on?
3. Is the ECO Reset button tripped? (See *Atwood Water Heater Operation Manual* in your Owners InfoCase.)

To Turn Water Heater Off

1. Turn switch on monitor panel to Off position.

2. Turn electric water heater switch off.
3. Turn off LP gas supply (if not to be used for extended period).
4. Drain water heater tank if the coach is to be stored or water heater will be Off during freezing temperatures. (See Draining and Storage Instructions in *Atwood Water Heater Operation Manual* in your Owners InfoCase.)

Water Heater Pressure-Temperature Relief Valve

On occasion, water may be seen seeping from the water heater pressure temperature relief valve. This is no cause for repair or replacement of the valve.

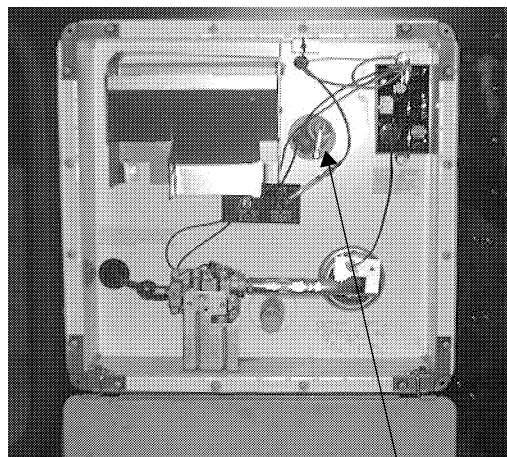

Water Heater Service Access - Exterior P-T Relief Valve

Normally there is an air gap at the top of the water heater tank which acts as a pressure buffer. In time, however, heated water may expand and fill this air gap, causing a slight increase in water pressure. This may cause the P-T valve to "weep" until the air gap is manually replaced.

To Replace the Air Gap:

1. Turn off the water heater switch and incoming water supply (city water and/or demand pump).
2. Open a faucet in the motor home to relieve water pressure.
3. Pull the handle of the P-T valve straight out and allow water to flow until it stops.

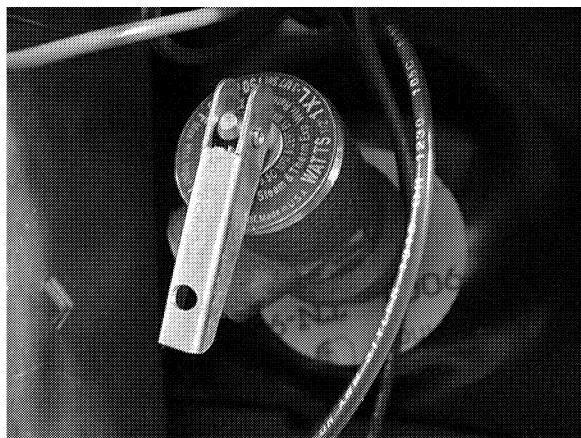
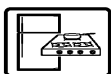

Lift straight out to open P-T valve

4. Let the handle of the P-T valve snap shut.
5. Close the faucet and turn on the water supply before switching the water heater on.

Manually operate the pressure temperature relief valve at least once a year. **OPERATE THIS VALVE ONLY WHEN THE WATER HEATER AND COOLING SYSTEM ARE COLD!**

CAUTION

Leave by-pass valve handle in **NORMAL FLOW** position if draining water and blowing out water lines. Place in **BYPASS** position **ONLY** when using antifreeze solution in water lines.

MOTOR AID (Optional)

The motor aid acts as a heat exchanger between the water heater and the vehicle engine. Two hoses from the water heater connect to the hoses which deliver hot water between the engine and the driver's compartment heater. A heat exchanger in the water heater then circulates the water from the engine radiator around the water heater tank. Under normal conditions, the entire contents of the water heater tank will be heated to approximately 140F in about two hours or 100 miles of driving.

In addition, the motor aid heat exchanger helps the vehicle engine to operate at cooler temperatures by dissipating heat from the engine. This reduces the possibility of overheating, particularly when operating in hot climates.

CAUTION

Any leak in the heat exchanger or its supply or return lines could cause loss of coolant and subsequent engine failure. We recommend that you periodically inspect these connecting lines and the heater to insure that no leaks have developed.

Motor Aid Water Heater and Rear Auxiliary Heater Maintenance

Have your authorized dealer check all hose clamp connections on the rear automotive heater and the motor aid water heater at least every six months and tighten them if necessary.

WATER HEATER BY-PASS VALVE

Your coach may be equipped with a water heater by-pass valve for easier winterization of water lines using RV antifreeze. The valve is located inside the coach near the water heater. See pg. 7-5 for the exact location in your coach.

Line up the arrow on the handle with the appropriate arrow on the valve plate to either by-pass or flow through the water heater.

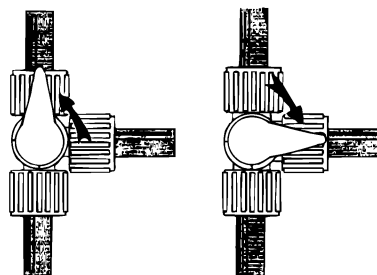

Normal Flow

By-Pass Mode

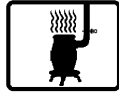
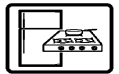

LP GAS FURNACE (SUBURBAN)

Start Up:

1. Open the LP gas tank valve by turning fully counterclockwise.

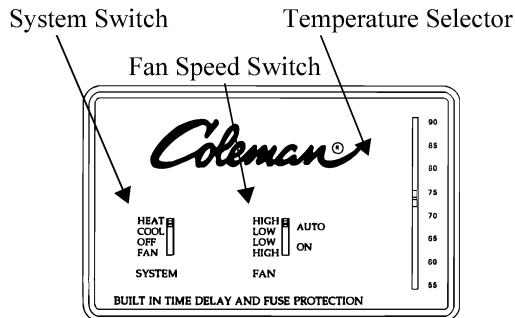

2. Move thermostat temperature selector from OFF position and place to desired temperature.
3. Furnace fan will start to blow immediately after setting thermostat.
4. After about 30 seconds, the furnace burner will light.
5. The furnace will now cycle off and on automatically as the thermostat demands just like a household furnace.

To Shut Down:

1. Slide SYSTEM switch to "OFF" position.
2. Close LP tank valve.

NOTE: If heat does not come out of the heat ducts after a minute or so the burner is not lit. Turn thermostat off for 3-5 minutes, check to be sure tank valve is open and tank is not out of fuel, then try steps 2-4 again. If it still will not light after three attempts, go to Shut Down steps and contact your dealer or a local RV service center.

For Further Information

Please see the Suburban furnace operating instructions provided in your Owner InfoCase for further information, including operating precautions, and periodic maintenance.

HEAT PUMP - Optional

Your coach may be optionally equipped with an air source heat pump built into the central air conditioning system. Because the heat pump operates on electricity, it provides economical heat inside your coach and helps reduce the use of LP gas for heating in cooler weather.

A heat pump can be thought of as an air conditioner running in reverse. An air conditioner absorbs heat from the air inside of the coach and moves it to the outside. The heat pump does exactly the opposite. Even cold air contains some heat, so a heat pump will extract heat from the outside air on a cold day and carry it to the inside of the coach to maintain a comfortable temperature.

The efficiency of a heat pump decreases as the outdoor air temperature drops, so supplementary heat is often needed when the outside temperature nears freezing. This system is set to automatically start the LP gas furnace to assist the heat pump if room temperature cools to 65° F or less. You may wish to manually switch to furnace heat to maintain a higher temperature when outside temperatures begin to reduce the efficiency of the heat pump. The heat pump will not operate when the outside temperature falls below 36 degrees F.

To turn on the heat pump:

The Heat Source selector switch is a separate module attached to the right side of the electronic thermostat as shown.

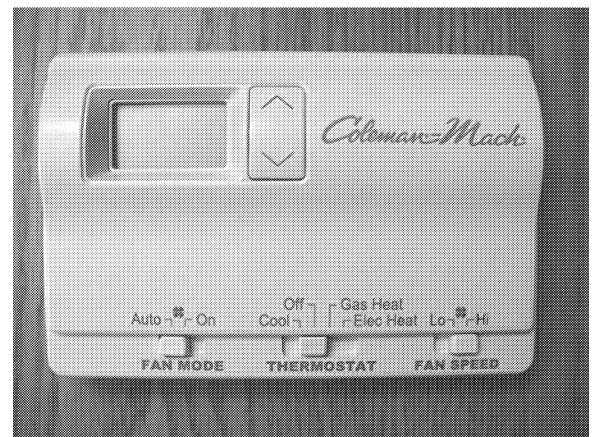

Gas Heat = Gas Furnace
Electric Heat = Heat Pump

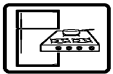

- To activate the Heat Pump, place the Heat Source switch in ELECTRIC position. (The furnace will automatically kick in when room temperature cools to 65° or less.)
- To turn the heat pump Off and use the LP gas Furnace only, place the switch in GAS position.
- The heat pump will not operate when the outside temperature falls below 36 degrees F.

Have you checked your air filter lately?

Closed or blocked vents and a dirty air filter can hinder the efficiency of a heat pump. See Air Conditioner Filter for location and instructions.

- Be sure ceiling vents are open to distribute heat pump output air. Also make sure furniture, clothing items, packages or other obstructions do not block the air return air grilles beneath the rear bed.
- The filter should be checked monthly for dirt build-up and replaced as needed. The air filter is a disposable woven fiberglass type, which cannot be cleaned and should be replaced when coated with dust.

Refer to the manufacturer's information in your InfoCase for complete operating instructions.

NOTE: The ducted roof air conditioning system has ceiling registers that can be closed if necessary to force more cool air toward a specific area of the coach or to route cool air away from a specific area. If too many vents are closed, however, it can cause the air conditioner unit to ice up and stop cooling, particularly in high humidity conditions.



DUCTED ROOF AIR CONDITIONING SYSTEM

Front and rear air conditioner units are controlled by separate wall thermostats. The front thermostat is located on a galley wall. The rear thermostat is located in the bedroom.

The front thermostat also controls furnace operation when the SYSTEM switch is placed in HEAT position. (See LP Gas Furnace).

The rear bedroom thermostat controls the rear air conditioner only and does not have HEAT position.

NOTE: These thermostats are equipped with a replaceable 2 Amp fuse located on the back of the thermostat body.

See "Air Conditioner Selector Switch" on following page for instructions on using two roof air units at once, if equipped.

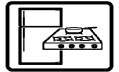

Operation

The following chart shows the system functions with the “Heat/Cool” thermostat. Disregard references to heat functions when using the “Cool Only” thermostat in the rear bedroom.

■ SHOWS POSITION OF SWITCH								OPERATION
* SYSTEM				AUTO FAN ON				
HEAT	COOL	OFF	FAN	HI	LO	LO	HI	
<input type="checkbox"/>	<input type="checkbox"/>	<input checked="" type="checkbox"/>	<input type="checkbox"/>	<input type="checkbox"/>	<input type="checkbox"/>	<input type="checkbox"/>	<input type="checkbox"/>	No functions occur.
<input type="checkbox"/>	<input type="checkbox"/>	<input type="checkbox"/>	<input checked="" type="checkbox"/>	<input type="checkbox"/>	<input type="checkbox"/>	<input type="checkbox"/>	<input type="checkbox"/>	Air conditioner fan runs at high speed continuously regardless of fan switch setting or setpoint. No other functions occur.
<input type="checkbox"/>	<input checked="" type="checkbox"/>	<input type="checkbox"/>	<input type="checkbox"/>	<input checked="" type="checkbox"/>	<input type="checkbox"/>	<input type="checkbox"/>	<input type="checkbox"/>	Air conditioner compressor, high speed fan and furnace high speed (if so equipped and wired), cycle to satisfy setpoint.
<input type="checkbox"/>	<input checked="" type="checkbox"/>	<input type="checkbox"/>	<input type="checkbox"/>	<input type="checkbox"/>	<input checked="" type="checkbox"/>	<input type="checkbox"/>	<input type="checkbox"/>	Air conditioner compressor, low speed fan and furnace low speed (if so equipped and wired), cycle to satisfy setpoint.
<input type="checkbox"/>	<input checked="" type="checkbox"/>	<input type="checkbox"/>	<input type="checkbox"/>	<input type="checkbox"/>	<input type="checkbox"/>	<input checked="" type="checkbox"/>	<input type="checkbox"/>	Air conditioner compressor cycles to satisfy setpoint. Air conditioner low speed fan and furnace low speed fan (if so equipped and wired) run continuously.
<input type="checkbox"/>	<input checked="" type="checkbox"/>	<input type="checkbox"/>	<input type="checkbox"/>	<input type="checkbox"/>	<input type="checkbox"/>	<input type="checkbox"/>	<input checked="" type="checkbox"/>	Air conditioner compressor cycles to satisfy setpoint. Air conditioner high speed fan and furnace high speed fan (if so equipped and wired) run continuously.
<input checked="" type="checkbox"/>	* <input type="checkbox"/>	<input type="checkbox"/>	<input type="checkbox"/>	<input checked="" type="checkbox"/>	<input type="checkbox"/>	<input type="checkbox"/>	<input type="checkbox"/>	Furnace and furnace high speed blower cycle to satisfy setpoint. Furnace blower operates from sequencer or time delay in furnace. During furnace operation, furnace overrides and forces fan to high speed. Air conditioning fan does not run.
<input checked="" type="checkbox"/>	* <input type="checkbox"/>	<input type="checkbox"/>	<input type="checkbox"/>	<input type="checkbox"/>	<input checked="" type="checkbox"/>	<input type="checkbox"/>	<input type="checkbox"/>	Furnace blower runs continuously at low speed (if so equipped and wired) until furnace cycles on to satisfy setpoint. Furnace overrides and forces fan to high speed during furnace operation. Air conditioning fan does not run.
<input checked="" type="checkbox"/>	* <input type="checkbox"/>	<input type="checkbox"/>	<input type="checkbox"/>	<input type="checkbox"/>	<input type="checkbox"/>	<input checked="" type="checkbox"/>	<input type="checkbox"/>	Furnace blower runs continuously at high speed (if so equipped and wired). Furnace cycles to satisfy setpoint.

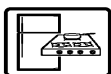

Furnace fan operation is available only if provided by the furnace manufacturer. The purpose of furnace fan operation simultaneously with cooling fan is to better circulate air within the conditioned space for a more uniform space temperature.

All cooling functions controlling to setpoint have a short cycle protection time delay of 3 minutes. There will be no delay if the cycle OFF time exceeds 3 minutes.

*There is no heat switch or furnace function available with the Cool Only thermostat.

WARNING
Never allow the antenna to touch electrical power lines or any other electrical wires.

Rotating Antenna - Make sure antenna is in the "UP" position. Pull down on rotating knob until it disengages ceiling plate and rotate for best picture and sound on TV set.



Lowering Antenna to Travel Position - Rotate antenna until pointer on rotating knob aligns with pointer on ceiling plate.

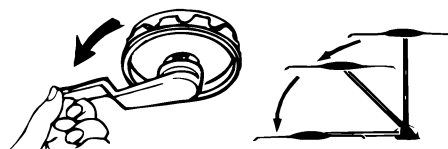

CAUTION
Never leave the antenna partially raised or partially lowered. This can damage the crank mechanism gears. Always raise the antenna straight up or lower it completely into the travel position.



TV ANTENNA - Optional

The TV antenna on your motor home can be easily raised, rotated a full 360° and lowered from inside the vehicle by simply turning a crank or rotating knob. A built-in signal amplifier designed to strengthen signals, is controlled by a power switch built into the TV jack assembly.

The signal amplifier is housed inside the antenna with the circuit board connected directly to the antenna elements. Power to operate the amplifier (12-volt DC) is supplied through the download cable which also carries the TV signals to the TV set. The power supply separates the 12-volt DC from the TV signals and provides a place for attaching the TV set and the 12-volt power source.

Operation

Raising Antenna - Turn elevating crank clockwise in "UP" direction about 13 turns or until some resistance to turning is noted. Antenna is now in operating position. Turn amplifier power switch "ON" to receive TV signal.



Turn elevating crank (counterclockwise) in "DOWN" direction until resistance is noted. Antenna is now locked in travel position. Turn amplifier power switch "OFF".

Count the number of turns needed to crank the antenna down to the roof of the unit (normally about 13). Mark the final position of the crank handle on the ceiling or the directional knob for reference. Also mark the number of turns needed. Use the mark and number as a reference whenever you lower the antenna.

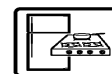

CAUTION

Always align directional handle to "DOWN" position before lowering.

TV SIGNAL AMPLIFIER

The amplifier power switch is located on a TV jack plate near the driver's compartment rear view mirror.

To operate amplifier, turn on power switch.

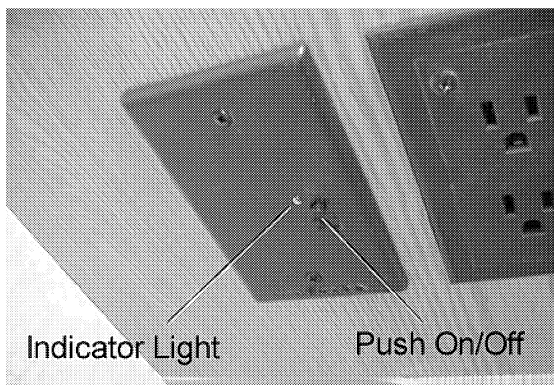

Other TV jack plates are mounted in various locations throughout the coach. Some of these wall plates are not readily visible and may be in one of the following locations.

- Beneath passenger side overhead cabinet.
- In front overhead TV cabinet, if equipped.
- In the flip-down entertainment tray on the outside of the coach.

Checking Reception

The TV signals available to an RV are entirely dependent on its location in relation to the transmitter. Signals may vary from strong to no usable signal at all. We recommend that the TV system be checked out in an area known to have good TV reception.

To check the antenna amplifier, raise the antenna, select a TV channel and rotate the antenna for best picture. Then turn off the amplifier power switch. If the antenna amplifier is working properly, the TV picture will now be degraded (snowy). When you turn the switch back on, the picture should again be sharp.

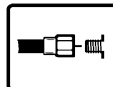

CABLE TV-HOOK-UP

Some models are equipped with external connections for cable television. The connector is located in the water center compartment.

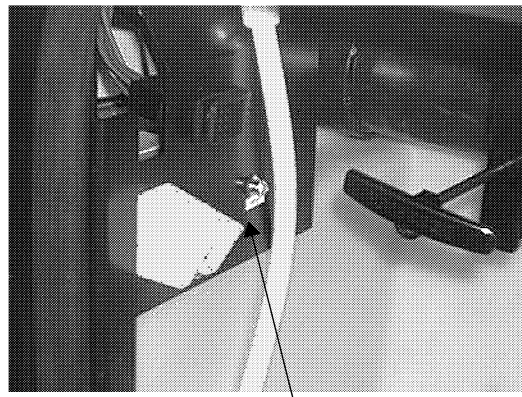

Cable TV Input Jack
(in Water Center Compartment)

NOTE: For coaches without the video control center option, be sure the TV antenna amplifier switch is turned OFF while connected to cable. The antenna amplifier will make the cable TV signal snowy.



VIDEO SELECTOR SYSTEM - Optional

The optional video selector system allows you to switch the antenna, cable TV or VCR signal to any TV set location in the coach.

This means one person can watch a ball game coming in on the roof antenna on the bedroom TV while another person watches a cable TV program or a video tape on the VCR on the front TV. Also, two people can watch different programs on the two TV's while taping a third program on the VCR.

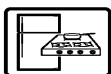

DC/AC Inverter Video Selector System

Components

FRONT TV

VCR = (Videocassette Recorder)

TV2 = (Bedroom or Rear TV)

Signal Inputs:

AUX - Press to connect VCR or selected TV to an electronic accessory component which you may have installed later, such as a Digital Video Disc (DVD) player.

SAT - Press to connect VCR or selected TV to the Digital Satellite System (dish antenna).

ANT - Press to connect VCR or selected TV to the roof antenna.

VCR - Press to connect selected TV to the VCR.

CABLE - Press to connect VCR or selected TV to a cable TV system hookup.



**SATELLITE
TELEVISION SYSTEM -
Optional**

The Satellite Television System allows you to receive TV programs directly from satellite to your coach. The programs are transmitted in digital format so the quality is equal to laser disc or CD.

See your **Winegard RV Digital Satellite Antenna System Owner's Manual** for instructions about aiming the satellite antenna dish. There is a supplemental Quick Reference Guide for the system with Receiver. The coach must be level before attempting to aim the antenna dish.

See your **Satellite Receiver User's Manual** for instructions about setting up the receiver and remote unit.

We recommend that you **read** both of these manuals **thoroughly** to understand the system completely before attempting any setups or adjustments.

Satellite System with Optional Video Control Center: Press the SAT switch to connect the TV to the Satellite system. The satellite system is hooked through the SAT input of the video control center.

Satellite System without Optional Video Control Center: Turn off the power switch for the TV Antenna Signal Amplifier to route the system signal to the TV input jacks.

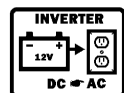

**DC-AC ELECTRICAL VOLTAGE
INVERTER - Optional**

The voltage inverter changes 12 volt DC current into 110 volt AC current to operate your TV and VCR while traveling or when shoreline hookup is not available.

The voltage inverter is located in the video center in the right front overhead cabinet above the drivers compartment.



DC-AC Voltage Inverter
in Video Center

- The inverter must be switched on to operate.
- Turn the inverter off when not in use to avoid draining the coach or automotive batteries.

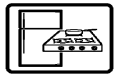

EXTERIOR ENTERTAINMENT CENTER

The exterior entertainment center contains a stereo radio/cassette player and convenient TV hook-ups for your outside listening or viewing pleasure.

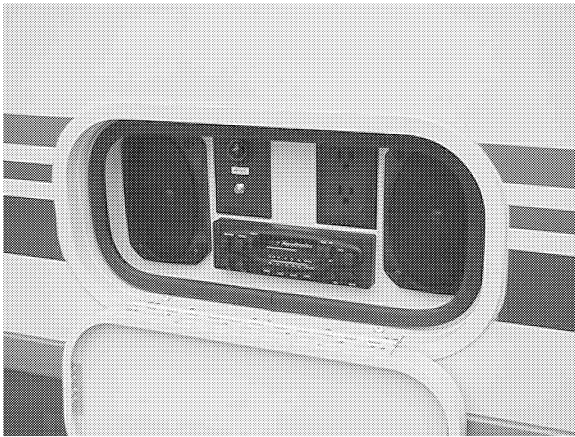

Exterior Entertainment Center



SLEEPING FACILITIES

WARNING

Do not use sleeping facilities while vehicle is moving.

OVERHEAD FRONT BUNK

The overhead front bunk is located above the driver's compartment. The rear mattress section is stored on top of the front section when not in use. A bunk ladder (supplied) can be hooked into the brackets on the rear edge of the mattress for easier access and exit.



Front Overhead Bunk
Shown with mattress sections in use position



Front Bunk Ladder
Shown hooked into mattress bracket

COUCH/BED CONVERSIONS

Continental Bed

To Convert Couch to Bed:

1. Remove the backrest cushions from the couch.
2. Grasp the front edge of the couch and pull upward and outward from the wall at the same time.
3. Lift the front edge of the seat cushion and unfold it toward the wall until it lies flat, forming a sleeping surface.

To Revert to Couch:

1. Fold mattress forward from the wall to return the seat cushions upright.

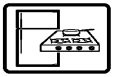

2. Pull the front of the couch upward and push in toward the wall at the same time until fully seated against the wall.
3. Place the backrest cushions in their original locations.

Presto Bed/Shock Bed

To Convert Couch to Bed:

Pull the front edge of the couch seat upward and outward from the wall while gently pushing downward on the backrest until the cushions lie flat. The bed is now ready for use.

To Revert to Couch:

Push the front edge of the seat toward the wall while lifting upward on the backrest until the couch is fully seated against the wall.

DINETTE/BED CONVERSION

To Convert Dinette to Bed:

1. Release the catch on the table leg brace and fold the leg up against the bottom of the table.

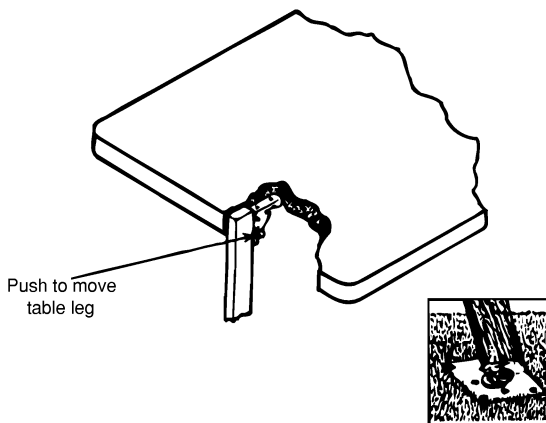

2. Remove the table from the wall support bracket by lifting the end of the table. Then lower the table to rest on the cleats attached to each dinette bench.
3. Arrange dinette cushions to cover bed area.

To Revert to Dinette:

1. Replace the table onto the wall support and lower the table leg.

2. Make sure that the table leg is secured into the floor support bracket and the leg brace is locked.



FRESH WATER TOILET

The fresh water toilet in your motor home is very similar to the household type, except that it is designed to use only a small amount of water per flush. It uses a high velocity jet of water, producing a swirl effect, to efficiently cleanse the bowl. And since each flush uses fresh water, no special chemicals are required other than a deodorizing agent, if necessary.

Flushing The Toilet

1. To add water to the bowl before using, step on the small pedal to the right. Hold pedal until desired level of water is reached. Release pedal slowly - do not allow it to snap back. Generally, more water is required only when flushing solids

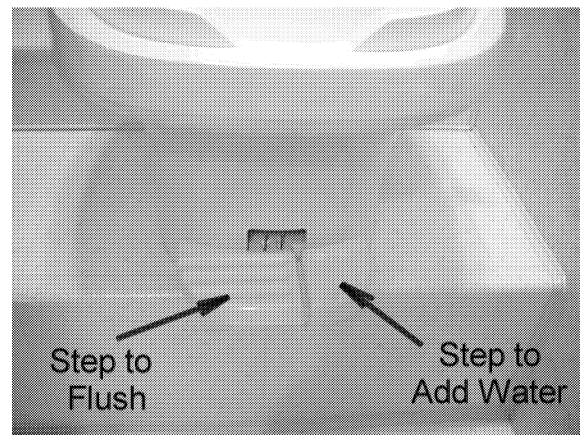

2. To flush the toilet, step on the large pedal to the left. (The large pedal also depresses the small pedal.) Hold pedal until bowl is clean
3. Release pedal slowly. A small amount of water should remain in the bowl.

Please refer to the manufacturer's information supplied with the toilet for further operating and maintenance instructions.

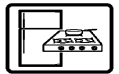

Important “Don’ts”

- Don't use facial tissue or regular toilet tissue in the RV toilet. These will not disintegrate sufficiently and will often cling to the sides of the holding tank. Toilet tissue made specifically for use in RV toilets and holding tanks is available at most RV supply centers.
- Don't dispose of sanitary napkins or other non-dissolving items in the toilet.
- Don't put automotive antifreeze or caustic chemicals, such as laundry bleach or heavy detergents into the toilet or holding tank. These products may damage plastic or rubber parts in the system.

Cleaning the Toilet

The toilet should be cleaned regularly for maximum sanitation and operating efficiency. If an odor is apparent from the toilet:

1. Clean the toilet bowl with a mild bathroom cleaner. Do not allow cleaners to set in the bowl for long periods of time to avoid damaging the seals. Do not use caustic or abrasive cleaners because it may damage the plastic surfaces.
2. Dump and rinse holding tank.
3. Add odor control chemical in amount specified after cleaning and every few days during use.
4. Remove the water line from the base of the toilet and clean the screen.
5. If the flush valve becomes stiff after extended use, it may be lubricated with a silicone spray. Turn the water pump off and operate flush pedal to drain water from the toilet bowl. Spray silicone lubricant onto flush valve inside bowl and operate flush pedal a few times to ensure free operation.

See instructions in Section 10 to prepare the toilet for storage in freezing conditions.

POWER ROOF VENT - Bath Area

Some models are optionally equipped with a powered roof vent in the bath area. A push button switch for the vent fan is located up on the vent. The vent dome can be raised and lowered using the crank handle.

SLIDER WINDOWS

Lift the latch handle straight out from the window. Grasp the sliding window edge frame and slide the window to the side. Be sure the latch is raised before trying to slide the window closed.

DAY/NIGHTER PLEATED WINDOW SHADES

Your coach may feature two-stage pleated window shades that can be used for daytime or nighttime privacy.

Sun Filter: The first, lower section is a translucent white shade that can be lowered for privacy without darkening the inside of the coach. It can also filter out harsh direct sunlight to help keep the inside of the coach cool in summer or to disperse light for houseplants.

Room Darkening/Privacy Shade: The second, upper section is an opaque, darkening shade for nighttime privacy and daytime room darkening purposes. Pull both the first and second sections down together or separately.

Tension Adjustment:

The tension of the pleated shades can be adjusted if they become loose and will not stay up when raised, or they are too tight and are difficult to raise and lower.

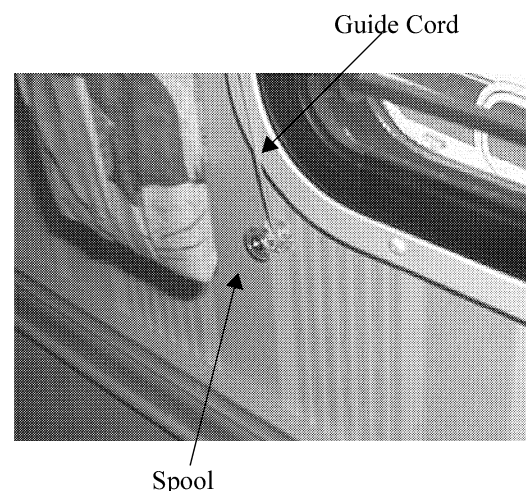

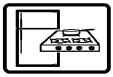

To tighten the tension, simply wrap the lower end of the guide cords (on each side of the shade) a few turns around the spools at the lower corners of the shades.

To loosen the tension, unwrap the guide cords from the spools one turn at a time until desired tension is achieved.

Preserving Shape:

The pleated shades are made using high quality materials that are designed and woven to retain their shape throughout their useful life. They may lose their crisp shape, however, if left in a lowered position for an extended period of time without being raised periodically. If this happens, the pleats can be restored using this simple method.

- With the shade fully lowered, dampen the entire area of the shade with a good quality laundry sizing spray.
- Raise the shade fully while still damp and let it remain in the raised position for about 24 hours, until the sizing has dried and “set”.
- Reapply sizing periodically (every few months) as needed.

We recommend that you fully raise pleated shades when they are not needed, especially in warm environments, to prevent them from losing their shape.

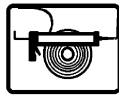
**SEALANTS****CAUTION**

Sealants must be inspected every 6 months and resealed if necessary.

ROOF

The roof is made of Thermo-Panel materials like the walls and floor. It will support the weight of an average adult should it become necessary to repair the roof or roof mounted components. It is not recommended, however, that very large or heavy objects be carried on the roof while the vehicle is in motion. (See page 4-1 for roof loading specifications.) Always have damage to the roof area repaired immediately. Damaged or detached sealant around the vents, air conditioner, body-to-roof seams, etc., should also receive immediate attention. Delaying these repairs may allow water leakage and result in damage to interior ceiling and body panels, upholstery, etc.

UNDERBODY

Buildup of mud and dirt under the body can cause damaging rust on steel parts and can add needless weight to the vehicle. This, in effect, reduces the amount of cargo you can carry and remain with GVWR and GAWR limits.

Corrosive materials, such as those used for ice and snow removal and dust control, also accumulate on the underside of a vehicle. These materials should be removed by flushing the underbody regularly with water, especially areas where mud and other foreign materials collect.

EXTERIOR

The exterior surface of your motor home has an automotive finish. Frequent washing and thorough cleaning is recommended to prevent damage to the vehicle finish after exposure to damaging salts, calcium chloride, road tar, tree

sap, insects and other foreign material. Never wash the vehicle in direct sunlight, while the vehicle surface is hot, or using hot water.

Do not use strong soaps or detergents for washing the motor home. Always use a mild soap in warm water, a commercially prepared product for cleaning automotive finishes or your local car wash. Be careful when using pressure-type washers to avoid loosening exterior decals or sealants, etc.

After washing the motor home, carefully inspect caulking around window frames and vents and any other joints that may have separated. Re-caulking, if necessary, is quite simple. Appropriate compounds are sold at Winnebago and Itasca dealers, and the materials are quickly and easily applied. Also, inspect weather seals around door, etc., and if necessary have a dealer replace them immediately.

CAUTION

Never use a strong solvent such as lacquer thinner, or harsh abrasives on painted surfaces.

Waxing and Polishing

When water will not bead up and roll off the finish of your freshly washed vehicle, it's time to apply a new coat of hard wax (paste, not liquid) to the finish. Wax not only improves the appearance of the vehicle, but protects the finish against oxidation and corrosive substances.

We recommend using a wax that is compatible with painted and gel-coated fiberglass finishes.

If the finish begins to look dull or discolored, it may need to be cleaned with a polishing or cleaning compound.

NOTE: If you use a polish or a cleaning compound that does not contain a wax preservative, we recommend reapplying a coat of hard wax after cleaning or polishing the finish.

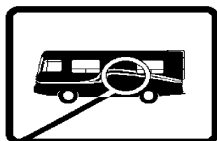

Care of Stripes and Decals



The pressure-sensitive decals on your coach require very little maintenance. They should be treated like any painted surface on your vehicle. Here are a few helpful hints on caring for decals:

- Wash decals with plain soap and water or any retail car wash soap. Always rinse thoroughly.
- Keep high-pressure wash nozzles at least 1 1/2 feet from edge of decals. High pressure water spray may cause edge lifting of decals.
- Test any cleaning solution on a small section of decal before using.
- Do Not use any aromatic solvents such as acetone, MEK, toluene, xylene, etc., on decals. Any solvent including alcohol may soften or smear colors.
- Do Not use lacquer thinner on paint or decals. Do Not overcoat decals with clear paint.
- Do Not let gasoline or other fuels drip and stay on decals for any length of time. Rinse immediately.

UPHOLSTERY, CARPETING AND DRAPERIES

We recommend a weekly routine of vacuuming all fabrics and carpet throughout the motor home to prevent an accumulation of dirt which can detract from the appearance and shorten the life of carpet and fabrics.

Carpet Care & Cleaning

See the carpet manufacturer's Carpet Care Guide in your Owner InfoCase. It includes detailed information on cleaning soils and removing stains from the fine carpet in your coach.

Upholstery

Some fabrics used in this motor home may contain fire retardant and lightfastness additives which can be damaged by use of improper cleaning products. Some water-based household cleaning products are not formulated for use on fabrics and may cause excessive shrinkage or fading. Always test any cleaning product on a hidden area of fabric before using on visible areas. For best results, fabric cleaning should be referred to a professional carpet and upholstery cleaner.

NOTE: To minimize fading of upholstery, carpets and other interior fabrics caused by excessive sunlight, the drapes, blinds or shades should be closed when the motor home is parked for an extended period of time.

WARNING

When cleaning upholstery and fabric, do not use lacquer thinner, nail polish remover, laundry soaps, or bleach. Never use carbon tetrachloride, gasoline, or naphtha for any cleaning purpose. These materials may cause damage to the material being cleaned and most are highly flammable.

Spots and Stains

Spots or stains should be treated as soon as possible before they "set in" to avoid permanent damage. Always start from the outside of a spot or stain and work inward to avoid spreading it. Use a clean cloth or sponge and turn frequently to an unused area of the cloth or sponge as you clean.

Some stains or soils, such as lipstick, ink, grease or mustard, are extremely difficult or impossible to remove completely and should receive immediate attention. Consult a professional carpet and upholstery cleaner for assistance.

Vinyl Fabrics

Vinyl should be cleaned with a soft, damp cloth, and a mild detergent only. Do not use solvents. Solvents may damage the surface of the vinyl.



Draperies, Curtains and Bedspreads

These items may be woven from a variety of fabrics. We recommend that these be professionally dry cleaned only. A five percent shrinkage may occur when you have these items dry cleaned.

CABINETRY

Wooden items may be cleaned with a soft cloth and a good quality wood finish cleaning product such as Guardsman™ or equivalent.

Vinyl simulated wood (Plus-Wood) panels may be cleaned with a mild, water based cleaner and a soft cloth. Do not use solvents on vinyl wood panels.

NOTE: Many cabinetry and furniture items throughout this motor home are constructed either partially or completely of real hardwoods. Because of natural variations in woodgrain density, slight differences in stain hue may exist between one item and another. This is the distinctive character and beauty of real wood.

VINYL WALLBOARD

Decorative vinyl covered wallboards may be cleaned with a mild solution of water and isopropyl (rubbing) alcohol or a mild soap solution. Do not use solvents or abrasive cleaning products.

TABLES AND COUNTERTOPS

Work surfaces are covered with a plastic laminate that resists solvents, stains and abrasions. A coat of furniture wax applied to these surfaces on the counters and table will help preserve their beauty and make cleaning easier. Always clean the surface before applying wax.

STAINLESS STEEL SINK

The stainless steel sink can be cleaned with soap or detergent. Rinse thoroughly with warm water and wipe dry to avoid streaks.

Use a mild abrasive for stubborn stains. Work in the direction of the polish lines. To keep the

original finish, polish with a wax cleaner and rub with a dry soft cloth.

WARNING

Salts, mustard and mayonnaise may cause pitting. If spilled, clean immediately.

RANGE AND REFRIGERATOR

For care and appearance maintenance of the range and refrigerator, refer to the operation and maintenance manual for each of the individual appliances included in your Owner InfoCase.



BATHROOM

The tub and shower walls in the bathroom should be cleaned with a mild soap and water solution, or (to obtain maximum luster) use a good quality wax cleaner. Do not use an abrasive cleaner on the shower walls and tub. If the shower has a glass door, it is extremely important that abrasives not be used. Use only a good quality glass cleaner or mild detergent and water solution with a soft cloth to clean glass surfaces.

The bathroom lavatory is also a molded plastic material and should be cleaned with a mild soap and water solution. Abrasive cleaners or harsh detergents should not be used.

For instructions on the care of your fresh water toilet, refer to the information in your Owner InfoCase.



DOORS AND WINDOWS

Windows may be periodically cleaned with a good quality glass cleaner or mild soap solution using a soft cloth. Use care when removing ice or frost from the windows. Always use a plastic ice scraper, never one made of metal. Use care when removing ice from the mirrors to protect the reflective surfaces.



SECTION 9 CARE & MAINTENANCE

Minnie Winnie

Door locks and hinges should be lubricated periodically with powdered graphite to ensure trouble-free operation and to protect against freeze-up.

WINDOW ROLL-UP SHADE ADJUSTMENT

If a roll-up type window shade in your motor home does not roll up or down fully, the spring tension may need adjustment.

Spring Too Weak:

- Roll shade about half-way down on window.
- Remove shade from bracket.
- Roll shade snugly by hand and replace onto bracket.

Spring Too Strong:

- Roll shade all the way up.
- Remove shade from bracket.
- Unroll shade one or two turns as necessary by hand and replace onto bracket.

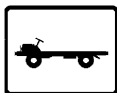

VEHICLE MAINTENANCE

(See also Safety Precautions, Section 1 of this manual).



CHASSIS SERVICE & MAINTENANCE

Consult the appropriate sections in your chassis operating guide for specific information regarding operating safety, service recommendations and maintenance schedules for the chassis section of your motor home.

ENGINE ACCESS

Refer to your chassis operating guide.



ENGINE COOLING SYSTEM

Refer to your chassis operating guide for information and precautions on filling, servicing and checking the fluid level.

CAUTION

When refilling the coolant system of a vehicle equipped with a rear auxiliary automotive heater and motoraid water heater, be sure to allow for additional coolant capacity of the heater and its supply and return hoses.



TIRES

Low air pressure results in tire overloading and abnormal wear and also affects handling and fuel economy. Obtain proper inflation pressures from your chassis operating guide or tire manufacturer.

WARNING

Make sure all replacement tires are of the same size and ply rating as those installed as original equipment.



SUSPENSION ALIGNMENT AND TIRE BALANCE

The front suspension and steering system of this vehicle was factory aligned using highly accurate equipment prior to delivery to the dealership. However, we recommend that alignment be checked and adjusted, if necessary, after you have fully loaded the motor home according to your personal needs. Thereafter, the alignment should be periodically inspected to help prevent uneven tire wear.

Any excessive or abnormal tire wear may indicate worn or misaligned suspension or steering, unbalanced tire or other tire/suspension problem.

Alignment can be affected by worn steering/suspension parts or by incidents which happen during driving, such as hitting a curb, pothole or railroad track, etc. Improper alignment can cause tires to roll at an angle and wear unevenly. It may also cause the vehicle to “pull” to the right or left. Have your dealer inspect your vehicle’s suspension and steering components periodically for misalignment or wear.

Out-of-balance tires will not roll smoothly and can lead to annoying vibrations and uneven tread wear such as cupping and flat spots. Tires may need to be balanced if uneven wear is detected or if ride comfort decreases noticeably.

See your chassis operating guide for further information.

Ride-Rite Helper Springs Optional - 27', 29' & 31' models

Check and adjust the air bag pressure periodically to maintain optimal ride and handling characteristics according to cargo weight.

Min. press.: 20 p.s.i.

Max. press.: 100 p.s.i.

Air Spring Valves



Rear Helper Spring Air Valves
located inside left rear wheelwell



WINDSHIELD WASHERS AND WIPERS

See your chassis operating guide for recommendations and precautions regarding washers and wipers.



LIGHTS

All exterior lights should be checked for proper operation each time the vehicle is prepared for a trip. Any bulbs which fail to light should be checked and replaced, when necessary, with a new bulb of the same size. A failure of more than one light, such as both taillights not operating, may indicate a burned out fuse. Check fuse and replace with one of the same rating when necessary. If a fuse is not the cause of the problem, the wiring system should be checked immediately by an authorized service center.

The headlight circuit is protected by a circuit breaker. An overload on the breaker will cause the lights to flicker on and off. Headlight wiring should be checked immediately anytime this condition is apparent. Refer to your chassis operating guide for further information.

AUTOMOTIVE 12-VOLT FUSES AND CIRCUIT BREAKERS

The automotive fuses and breaker are protected from short circuit and overload conditions by a fuse block. On most models, this is located beneath the dash to the left side of the steering column. See your chassis operating guide for additional fuse replacement information.

AWNING INSTALLATION

NOTE: See your Winnebago or Itasca dealer for installation of awnings. Your dealer's service department has information showing locations of awning bracket supports in the sidewall of the coach.



CAUTION

Improper awning installation may result in damage to the coach.



PREPARING VEHICLE FOR STORAGE

Properly preparing your vehicle for storage will lessen the possibility of damage to your vehicle. Prepare the motor home for vacancy just as you would if you were leaving your house for an extended period:

- Remove all perishables from cabinets and refrigerator
- Prop refrigerator door open.
- Turn off LP gas tank.
- Drain water heater, water tank and holding tank.
- Close shades to protect upholstery from sunlight

When storing your vehicle through the winter, or in cold climates, extra preparations need to be made to protect systems that can be damaged by freezing temperatures.



Cold Weather Storage Procedure (Winterizing)

1. Clean and dump holding tanks by following steps A, B, and C
 - A. Add water to the sewage holding tank by holding the toilet flush lever open with the water pump running. Add water to the waste water holding tanks by opening the kitchen, shower and lavatory faucets. Tanks should be about 1/4 to 1/3 full to rinse properly. Driving to a disposal site will normally loosen and rinse any waste material from the sides of the tank.
 - B. Completely drain the sewage and waste water holding tanks at an approved waste disposal site. Drain the sewage tank first so the following waste water can rinse any waste solids from the dump outlet and sewer hose.
 - C. Close dump valves and refit the dust cap onto the drain outlet.
2. Level the motor home and drain the entire plumbing system as described in the following steps.
3. Open all drain valves. (See the water system drain valve chart on **page 7-5** for locations on your model.)

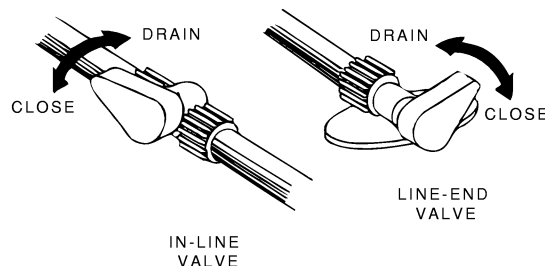

NOTE: If your coach is equipped with a water purifier system, you will need to remove the filter cartridge and install the diverter plug supplied. The cartridge is located beneath the galley sink counter. The diverter plug must be removed and a filter cartridge installed before resuming normal use of the water system. The plug is intended for winterization only.

4. Turn the Water Pump switch ON to allow it to operate until you are done draining all faucets and toilet.
5. Open all faucets and shower head valves, including exterior shower.
6. Operate the toilet flush pedal and hold until water stops flowing in the toilet. Then turn water pump switch OFF.
7. Turn off the water heater power switch before draining the water heater tank to avoid damage to the heating element.
8. Drain the water heater by removing the plug from the base of the water heater tank, accessible from the outside of the coach. (Requires socket and ratchet.) Also open the Pressure-Temperature relief valve at the top right portion of the tank to prevent air locking in the tank while draining.



SECTION 10
STORING YOUR MOTOR HOME

Drain Plug P-T Relief Valve

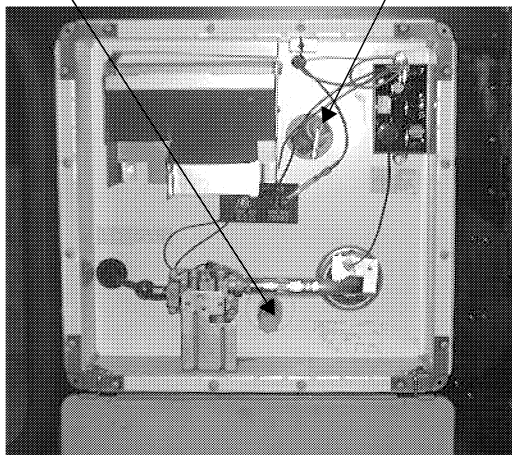

WATER HEATER SERVICE ACCESS
EXTERIOR

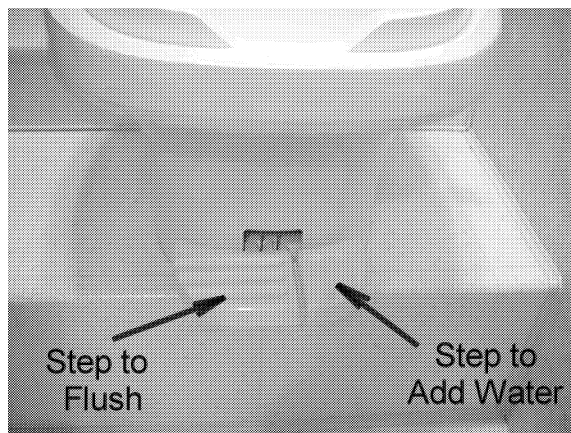

9. After water has stopped draining at all faucets and drain valves, connect a “blow-out” plug to the city water connection on the coach. Then use a hand pump or air compressor regulated to 30 psi or less to force air through the system. (A “blow-out” plug can be purchased at any Winnebago or Itasca dealer. P/N 701705-01-000.)

12. Now turn air pressure off and disconnect water purge adapters. Recap the city water connection to avoid contamination by dirt or insects.
13. Close all drain valves and faucets to avoid contamination by dirt or insects. Reinstall water heater drain plug and close P-T relief valve.
14. Pour about one cup of non-toxic RV antifreeze into the kitchen sink drain, bathroom sink drain and shower drain. This prevents any holding tank odors from entering the coach during storage.

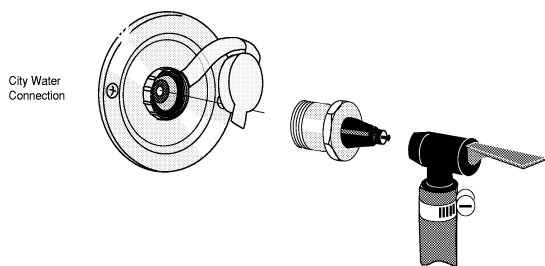

CAUTION
Limit air pressure to 30 psi to avoid damage to pump or water lines.

WARNING
NEVER use automotive antifreeze/coolant in your RV water system. Auto antifreeze contains Thelonyl glycol which, if ingested, can cause blindness and can be fatal.

NOTE: DO NOT burst air into the system. This can damage the water pump. It is better to let air in slowly.

10. Let air flow for five minutes until water is completely drained out of faucets and drain valves. Then close faucets one at a time.
11. Operate and hold toilet flush pedal until water is completely drained from toilet.

It is not necessary to add antifreeze to the toilet since the flush valve will be closed.

Do not add automotive antifreeze or caustic chemicals such as bleach or laundry detergents into the toilet bowl or holding tanks. Although these products may have a deodorizing effect, they may damage plastic and rubber parts in the system.



NOTE: *As an alternative to totally draining the plumbing system, you may winterize tanks and lines by pumping non-toxic RV antifreeze through the system. This product is available from your dealer and from most RV supply stores. Follow directions on the container to determine the correct amount to use for your coach. See “Water System Winterization Valve” on page 7-4 for instructions on injecting RV antifreeze into water lines.*

15. Place a bucket beneath the sewage drain valve outlet and re-drain the sewage and waste holding tanks of any clean water that entered during “blow-out” procedure.

Close dump valves to prevent valve shafts from rusting and to prevent entry by rodents and insects. Refit the dust cap onto the drain outlet.

Your drainage and fresh water systems are now totally winterized.

16. Have the vehicle chassis completely serviced and lubricated. Be sure radiator antifreeze protection level is sufficient for the lowest anticipated temperatures.
17. Wash and wax the coach.
18. Inspect all seams and seals around doors, windows, vents, and any other joints. Replace or repair any that are damaged. Sealing materials and compounds can be purchased from your dealer. Badly damaged weather seals may need to be replaced by your dealer.
19. Close all windows and roof vents. Protect all appliance vent openings from contamination by animals or insects (e.g. bird nests, wasp nests, etc.)
20. Lubricate all door hinges and locks.
21. Clean the interior of the coach. Dirt and stains are more easily removed when fresh.
22. Remove all foods and items that may cause odors.
23. Clean and defrost the refrigerator. Leave the door slightly ajar to allow any odors to dissipate. Place an open box of baking soda

- inside the refrigerator to help absorb odors.
24. Turn the furnace thermostat switch on the bottom of the thermostat to OFF.
25. Turn auxiliary battery (Aux Batt) switch off. If your coach does not have an Aux Batt switch, disconnect all chassis and auxiliary battery cables.
26. Fully charge batteries.
27. Batteries must be kept to at least 80% charge to keep from freezing or sulfating. We recommend that you connect a battery charger and fully charge batteries at least once a month during long-term storage periods to maintain charge at 80% or greater. Turn Aux. Batt. switch off to avoid electrical arcing when attaching and detaching charger clamps. Turn the Aux. Batt. Switch off to avoid electrical arcing when attaching or detaching charger clamps.

NOTE: *We do not recommend leaving the shoreline plugged in continuously during storage period because the batteries can lose electrolytic fluids and become damaged from continuous charging without periodic use.*

We recommend following regular battery inspection and maintenance, especially in cold weather.

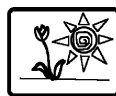

REMOVAL FROM STORAGE

1. Completely air out the motor home.
2. Have the entire LP gas system checked for leaks.
3. Check window operation.
4. Check cabinet and door hinges. Lubricate with penetrating oil, if necessary.
5. Close all faucets and drain valves that are open. If necessary, reconnect toilet water line and close flush valve.
6. Add a few gallons of water to the fresh water tank and check for leaks especially at junctions. Also make sure all hangers and supports are securely in place. Sanitize the water



SECTION 10 STORING YOUR MOTOR HOME

Minnie Winnie

system as outlined under “Disinfecting the Fresh Water System” in Section 7.

7. Check operation of all faucets to be sure faucet washers have not hardened during storage.
8. Check sealing valve in the toilet for proper operation and lubricate with silicone spray.
9. Add water to the holding tank using the toilet flush pedal. Check to be sure dump valve seals tightly.
10. Check around all appliances for obstructions and ensure that all vent openings are clear.
11. Start refrigerator and check for proper cooling.
12. Clean paneling and counter surfaces and apply a thin coat of wax.
13. Replace batteries if necessary and check out electrical system to make sure all lights and electrical components operate.
14. Check tires for proper cold inflation pressure.
15. After washing accumulated winter grime from the vehicle, it is important to carefully inspect the seams and sealants for separation or cracks that may have appeared around the window frames, vents and any other joints. Re-sealing is quite simple and the material is quickly and easily applied. Appropriate compounds are available from your dealer. Also inspect weather seals around doors, etc., and if necessary, have a dealer replace immediately.

Minnie Winnie

INDEX

A

Air Conditioner, Automotive	2-11
Air Conditioner, Ducted Roof	8-12
Alarm, LP Gas	1-3
Alignment, Suspension and Tire Balance	9-4
Amplifier, Antenna Signal	8-15
Antenna, TV	8-14
Antenna Signal Amplifier	8-15
Automotive (Starting) Batteries.....	6-6
Auto 12V Fuses & Circuit Breakers	6-6, 9-5
Auxiliary Battery Switch	2-11
Aux Start Switch.....	2-11
Auxiliary (House) Batteries	6-7
Auxiliary 110-Volt Generator.....	6-4 - 6-5

B

Bathroom, Care of.....	9-3
Batteries, Automotive (Starting)	6-6
Batteries, Auxiliary (House)	6-7
Battery Charger, Connecting	3-3
Battery Condition Meter	6-8, 8-7
Battery Information.....	6-7
Battery Maintenance	6-7
Battery Switch, Aux.....	2-11
Beds, Converting for use	8-17
Before Driving your Vehicle	2-1
Before Entering your Vehicle	2-1
Brake, Parking	2-3
By-Pass Valve, Water Heater	8-10

C

Cabinets	9-2
Cable TV Hook-Ups	8-15
Campsite Selection	4-6
Capacity, Fuel Tank	2-2
Capacity, Water ¹ and Holding Tanks	7-1, 7-6
Carbon Monoxide Alarm	1-5
Carbon Monoxide Warning	1-5
Carpets, Care of	9-2
Charging Section.....	6-2
Chassis Operating Guide	0-1
Chassis Service and Maintenance.....	9-4

Checklists,

1. Capacity chart is also conveniently located on the back of "To The Owner" page inside front cover of this manual.

Pre-Travel	4-3
Child Restraints.....	2-8
Circuit Breakers, 12-Volt	6-6, 9-5
Circuit Breakers, 110-Volt	6-3
City Water Hook-Up.....	7-2
Cold Weather Storage (Winterizing)	10-1
Comfort Controls	2-11
Condensation, Humidity and	4-7
Connecting a Battery Charger.....	3-3
Connecting the Shoreline.....	6-1
Converter, Electrical Power	6-2
Cooling System, Engine	9-4
Couch/Bed Conversion	8-17

D

Day/Nighter Pleated Shades	8-19
Decals and Stripes	9-2
Defects, Reporting Safety	0-2
Digital Satellite Television System.....	8-16
Disinfection of Fresh Water Tank	7-2
Door Handles and Locks.....	2-3
Doors and Windows, Care of.....	9-3
Drain Valves, Water	7-4
Drainage System	7-2
Draperies, Care of.....	9-2
Drinking and Driving.....	0-2
Driver Seat	2-5
Driving Safety Precautions	1-1
Dumping Holding Tanks	7-4

E

Effects of Prolonged Occupancy	4-7
Electrical Outlets, 110-volt	6-3
Electrical Safety Precautions	1-4
Electrical System, 110-volt AC	6-1
Electrical System, 12-volt DC	6-6
Emergency Exits	1-6
Engine Access.....	9-4
Engine Cooling System	9-4
Engine Overheat	3-3
Entertainment Center, Exterior	8-17
Entrance Door Lock and Handle	2-3
Entrance Steps, Electric	2-3
Equipment, Options and	0-2
Exits, Emergency	1-6
Exterior Body Care	9-1
Exterior Entertainment Center	8-17
Exterior Features.....	0-5

INDEX

Exterior Shower	7-3	LP Gas Leaks	1-2, 5-4
External (City Water) Connector	7-2	LP Gas Level	8-6
External Power Cord (Shoreline).....	6-1	LP Gas Pressure Regulator	5-3
F		LP Gas Safety	5-1
Filling the Fuel Tank.....	2-2	LP Gas Selection.....	5-2
Fire Extinguisher	1-7	LP Gas Tank, Air in the	5-3
Formaldehyde Warning	1-5	LP Gas Tank, Refilling	5-3
Fresh Water Tank.....	7-1	LP Gas Tank System.....	5-2
Disinfection of	7-2	LP Gas, Travel with	5-3
Drain	7-3	LP Gas, Winter Use of	5-5
Filling	7-1	M	
Fresh Water Toilet	8-18	Microwave Oven.....	8-5
Fuel Selection	2-2	Mirrors	2-9
Fuel Tank Capacity.....	2-2	Monitor Panel	8-6
Fuel Tank, Filling	2-2	Motor Aid Water Heater	8-10
Furnace, LP Gas	8-11	Mountain Driving	4-5
G		N	
Gas Alarm, LP	1-3	Nighttime Driving.....	4-5
Gas Leaks, LP	5-4	O	
General Warnings	1-1	Occupancy, Effects of Prolonged	4-7
Generator, Auxiliary 110-Volt	6-4 - 6-5	Operating the Oven.....	8-5
Generator Hourmeter	6-5	Options and Equipment	0-2
Ground Fault Circuit Interrupter.....	6-3	Outlets, 110-Volt	6-3
H		Oven Pilot	8-4
Hazard Warning Flashers.....	2-3, 3-1	Overload Protector, Thermal	6-3
Heater, Automotive.....	2-11	P	
Helper Springs, Rear - Ride-Rite.....	9-5	Parking Brake	2-3
Holding Tank Level Indicators	8-6	Pilot, Lighting Oven	8-4
Hourmeter, Generator	6-5	Pleated Shades, Day/Nighter	8-19
Humidity and Condensation	4-7	Power Converter	6-2
I		Power Roof Vent	8-19
Instrument Panel	2-9	Pre-Travel Checklist	4-3
Interior Care.....	9-2 - 9-3	Preparing Vehicle for Storage	10-1
Inverter, DC-AC Voltage.....	8-16	Pressure Regulator, LP Gas	5-3
J		Prolonged Occupancy, Effects of	4-7
Jump Starting	3-2	Pump Switch, Water	7-1
K		R	
Keys	2-2	Radio/Cassette Player, Dash.....	2-11
L		Radio Security Reminder, Sony.....	2-9
Lights	9-5	Range and Oven.....	8-4
Loading, Roof	4-2	Range Hood	8-5
Loading the Vehicle	4-1	Recovery Towing.....	3-2
Lounge Chairs.....	2-5	Refrigerator	8-1
LP Gas Alarm	1-3	Regulator, LP Gas.....	5-3
LP Gas Furnace	8-9	Relief Valve, Water Heater.....	8-9, 8-10
		Removal from Storage.....	10-3
		Reporting Safety Defects	0-2

Restraints, Child.....	2-8
Ride-Rite Helper Springs.....	9-5
Roof Loading	4-2
Roof Maintenance.....	9-1
Roof Vent, Power	8-19

S

Safe Use of LP Gas System	5-1
Safety Defects, Reporting	0-2
Satellite Digital Television System.....	8-16
Seat, Driver	2-5
Seat Belts and Child Restraints.....	2-7
Seats	2-5
Selecting Fuel Types, LP	5-2
Service Assistance	0-2
Severe Weather Information	4-4
Sewer Hook-Ups, Using On-Site	7-4
Shades, Day/Nighter Pleated	8-19
Shoreline, Connecting the	6-1
Shower Valve Pressure Bleedoff.....	7-3
Shower, Exterior	7-3
Signal Amplifier, TV Antenna.....	8-15
Sink, Stainless Steel	9-3
Sleeping Facilities.....	8-17
Slideout Room	2-12 - 2-16
Slider Windows.....	8-19
Smoke Alarm	1-7
Spare Tire.....	3-1
Spots and Stains.....	9-2
Springs, Ride-Rite Rear Helper	9-5
Start Switch, Aux	2-11
Starting and Stopping the Engine	2-3
Step, Entrance	2-4
Storage, Preparing Vehicle for	10-1
Storage, Removal from	10-3
Stripes and Decals.....	9-2
Suspension Alignment and Tire Balance.....	9-4

T

Table and Countertop Surfaces.....	9-3
Tank, Fresh Water Filling	7-1
Tank Capacities, Water and Holding.....	7-1, 7-4
Television, Digital Satellite System.....	8-16
Tension Adjustment, Pleated Shades.....	8-19
Thermal Breaker	6-3
Tire, Spare	3-1
Tire Balance, Suspension Alignment and	9-4
Tire Changing	3-1
Tires	9-4
Toilet, Fresh Water	8-18
Towing, Recovery	3-2
Trailer Towing	4-2

Trailer Wiring Connector.....	6-9
Travel Tips	4-4
Travel with LP Gas	5-3
TV Antenna.....	8-14
TV & Cable Hook-Ups,	8-15
TV Signal Amplifier	8-15

U

Underbody Care.....	9-1
Upholstery.....	9-2
Using On-Site Sewer Hook-Ups.....	7-4

V

Vehicle Certification Label (VIN).....	0-4
Vehicle Maintenance	9-4
Vents, Power Roof.....	8-19
Video Selector System.....	8-15
Vinyl Fabrics	9-2
Vinyl Wallboard	9-3
Voltage Inverter, DC-AC.....	8-16

W

Warnings:

Carbon Monoxide	1-5
Driving.....	1-1
Formaldehyde	1-5
Fuel & LP Gas	1-2
LP Gas Leaks.....	1-2
LP Gas Alarm	1-3
Electrical	1-4
Loading	1-4
Maintenance.....	1-4
Warranty	0-2
Water and Holding Tank Levels	8-6
Water Drain Valves	7-4
Water Heater, Motor Aid	8-10
Water Heater	8-7
Water Heater By-Pass Valve	8-10
Water Line Drain Valves	7-4
Water Pump	7-1
Water Pump Switch	7-1, 8-6
Water Tank, Disinfection of	7-2
Water Tank Filling	7-1
Wheel Nuts	3-2
Window Shades, Pleated.....	8-19
Windows, Cleaning	9-3
Windows, Doors and	9-3
Windows, Emergency Exit	1-6
Windows, Slider	8-19
Windshield Washers and Wipers.....	9-5
Winter Use of LP Gas	5-5
Winterization Valve.....	7-5
Winterizing	10-1

**IMPORTANT
SERIAL NUMBERS**

Motor Home (Coach): Year _____ Model _____ Serial _____
Chassis: Make _____ Serial (VIN) _____

Roof Air Conditioner:	Brand _____	Model _____	Serial _____
Furnace:	Brand _____	Model _____	Serial _____
Water Heater:	Brand _____	Model _____	Serial _____
Power Converter:	Brand _____	Model _____	Serial _____
110-Volt Generator:	Brand _____	Model _____	Serial _____
Range:	Brand _____	Model _____	Serial _____
Microwave Oven:	Brand _____	Model _____	Serial _____
Refrigerator:	Brand _____	Model _____	Serial _____
Television:	Brand _____	Model _____	Serial _____
Video Cassette Player:	Brand _____	Model _____	Serial _____

EMERGENCY INFORMATION

Dealer

Name _____

Address _____

Phone _____

INSURANCE POLICY

Company _____

Policy Number _____

Phone _____

