



## TABLE OF CONTENTS

---

### 1 – INTRODUCTION

About this Manual .....	1-1
Safety Messages Used in this Manual .....	1-1
Pre-Delivery Inspection .....	1-2
Front Axle Tire Alignment .....	1-2
Service and Assistance .....	1-2
Reporting Safety Defects .....	1-2
Occupant and Cargo Carrying Capacity Label .....	1-3
Vehicle Certification Label .....	1-4
Specifications and Capacities .....	1-5
Owner and Vehicle Information .....	1-6

### 2 – SAFETY AND PRECAUTIONS

General Warnings .....	2-1
Driving Safety .....	2-1
Fuel and Propane Gas .....	2-1
Propane Gas Leaks .....	2-2
Propane Gas Leak Detector .....	2-3
Carbon Monoxide Warning .....	2-3
Carbon Monoxide Alarm .....	2-4
Smoke Alarm .....	2-4
Fire Extinguisher .....	2-5
Electrical .....	2-5
Loading .....	2-5
Maintenance .....	2-6
Emergency Exits .....	2-6
Slideout Rooms .....	2-7
Formaldehyde Information .....	2-7
Mold, Moisture, and Your Motor Home .....	2-8
Roadside Emergency .....	2-8
Wheel Mounting Nuts (Lug Nuts) .....	2-10
Jump Starting .....	2-10
Engine Overheat .....	2-10

### 3 – DRIVING YOUR MOTOR HOME

Seats – Driver/Co-Pilot (Chassis Supplied) .....	3-1
Seats – Driver/Co-Pilot (Flexsteel) .....	3-1
Seat Belts .....	3-2
Keys .....	3-4
Remote Keyless Entry .....	3-4
Mirrors – Power Electric .....	3-4

# Table Of Contents



---

Power Sunvisor .....	3-5
Hazard Warning Flashers .....	3-5
Air Conditioner/Heater – Automotive (Dash) .....	3-5
Radio In-Dash/Rearview Monitor System .....	3-6
Infotainment Center/GPS .....	3-8
Battery Boost Switch .....	3-10
Engine Cooling System .....	3-10
Fuel Fill Access .....	3-10
Diesel Exhaust Fluid Fill .....	3-11
Lights .....	3-11
Valve Stem Access .....	3-12
Tires .....	3-13
Suspension Alignment and Tire Balance .....	3-14

## 4 – APPLIANCES AND SYSTEMS

Refrigerator .....	4-1
Refrigerator Service Access Compartment .....	4-2
Range Top .....	4-2
Microwave Oven .....	4-3
Range Hood .....	4-4
OnePlace® Systems Monitor Panel .....	4-4
Water Heater - Gas/ Electric .....	4-6
Pressure-Temperature Relief Valve .....	4-6
Propane Gas Furnace .....	4-7
Heat Pump .....	4-8
Ducted Roof Air Conditioning System .....	4-9
Air Conditioner Filter .....	4-9

## 5 – PROPANE GAS

Propane Gas Supply .....	5-1
Safe Use of the Propane Gas System .....	5-3
Propane Gas Warnings and Precautions .....	5-4
Propane Gas Pressure Regulator .....	5-4
Propane Vaporization in Cold Weather .....	5-5

## 6 – ELECTRICAL

Electrical Cautions .....	6-1
Electrical System – House 120-Volt AC .....	6-1
External Power Cord .....	6-1
Inverter Unit – 1000W .....	6-3
Power Center .....	6-4
Circuit Breakers – House 120-Volt AC .....	6-5
Electrical Outlets – House 120-Volt AC .....	6-5
Ground Fault Circuit Interrupter .....	6-5
Electrical Generator – 120-Volt .....	6-6
Electrical System – House 12-Volt DC .....	6-8

---

---

House/Coach Battery Disconnect Switch .....	6-8
Battery Access .....	6-9
Battery Care .....	6-10
Circuit Breakers and Fuses – House 12-Volt DC .....	6-11
<b>7 – PLUMBING</b>	
Fresh Water System .....	7-1
Water Pump .....	7-3
Cold Water Filter .....	7-4
Disinfecting Your Fresh Water System .....	7-6
Shower Hose Vacuum Breaker .....	7-6
Exterior Shower/Wash Station .....	7-7
Toilet .....	7-7
Drainage System (P-Traps) .....	7-7
Waste Water System - Model 25R .....	7-7
Waste Water System (Waste Pump) - Models 25T & 25Q .....	7-9
Holding Tank Heater .....	7-11
WaterLine and Tank Drain Valves .....	7-11
Water Heater Bypass and Antifreeze Siphon Valves .....	7-12
Winterizing Procedures .....	7-12
Water System Drain Valve Locations .....	7-19
<b>8 – ENTERTAINMENT</b>	
TV – 12V LED .....	8-1
TV – Pull out .....	8-1
Audio-Video System Basic Operation .....	8-1
DVD Player with Deluxe Sound .....	8-2
TV Antenna - Digital .....	8-3
TV Signal Amplifier .....	8-3
Cable TV and Satellite Connections .....	8-4
TV Digital Satellite System – Manual .....	8-4
TV Digital Satellite System Wiring .....	8-5
<b>9 – FURNITURE AND SOFTGOODS</b>	
Sleeping Facilities .....	9-1
Front Bunk .....	9-1
Flex Bed .....	9-2
Bed Extension .....	9-2
Comfort Sofa Sleeper .....	9-3
Dinette/Bed Conversion .....	9-5
Dinette Conversion .....	9-6
Window Shades/Screens .....	9-7
Roller Shades (Manual) - Solar Day/Night .....	9-8
Wood Furniture and Cabinetry .....	9-8
<b>10 – SLIDEOUT ROOMS</b>	
Slideout Room Travel Lock .....	10-1

---

---

Slideout Room Operation – Electric .....	10-2
Slideout Room – Extreme Weather Precaution .....	10-4
Slideout Room Troubleshooting (Power Gear®) .....	10-4
Slideout Emergency Retraction (Power Gear®) .....	10-6
General Slideout Care .....	10-8

**11 – MAINTENANCE AND STORAGE**

Sealants – Inspection and General Information .....	11-1
Roof .....	11-1
Undercarriage .....	11-1
Exterior Automotive Paint Finish .....	11-2
Exterior Graphic Care .....	11-4
Plastic Parts – Cleaning .....	11-4
Exterior Lights .....	11-5
Interior Soft Goods .....	11-5
Cabinetry – Cleaning .....	11-7
Tables and Countertops .....	11-7
Stainless Steel Appliances .....	11-7
Galley Sink .....	11-8
Range and Refrigerator .....	11-8
Vinyl Flooring .....	11-8
Bathroom .....	11-9
Doors and Windows .....	11-9
Vehicle Storage – Preparation .....	11-9
Vehicle Storage – Removal .....	11-10
Chassis Service and Maintenance .....	11-11
Coach Maintenance Chart .....	11-12

**12 – MISCELLANEOUS**

Loading the Vehicle .....	12-1
Weighing Your Loaded Vehicle .....	12-1
Car or Trailer Towing .....	12-3
Trailer Wiring Connector .....	12-4
Towing Guidelines .....	12-4
Entry Step – Electric .....	12-5
Windows .....	12-6
Power Roof Ventilator .....	12-8
Storage Compartment Doors .....	12-8
Power Awning .....	12-8
Effects of Prolonged Occupancy .....	12-9

---



## SECTION 1 – INTRODUCTION

---

Congratulations! We welcome you to the exciting world of motorhome travel and camping. You will find it convenient and enjoyable to have all the comforts of home and still enjoy the great outdoors wherever you choose to go. Your motorhome has been carefully designed, engineered, and manufactured to provide years of enjoyment.

Before sliding into the driver's seat, please become familiar with operations and features. In addition, spend some time with the dealer when you take delivery to learn all you can about your new motorhome.

---

---

### ABOUT THIS MANUAL

This operator's manual was prepared to aid you in the proper care and operation of the vehicle and equipment.

Please read this manual completely to understand how everything in your coach works before taking it on its "maiden voyage". In addition, please become familiar with the New Vehicle Limited Warranty.

*NOTE: This manual describes many features of your motorhome and includes instructions for its safe use.*

*This manual, including photographs and illustrations, is of a general nature only.*

***Some equipment and features described or shown in this manual may be optional or unavailable on your model.***

*Because of Winnebago Industries<sup>®</sup>, continuous program of product improvement, it is possible that recent product changes and information may not be included.*

*The instructions included in this manual are intended as a guide, and in no way extend the responsibilities of Winnebago Industries beyond the standard written warranty as presented in this manual.*

*The descriptions, illustrations, and specifications in this manual were*

*correct at the time of printing. We reserve the right to change specifications or design without notice, and without incurring obligation to install the same on products previously manufactured.*

The materials in your InfoCase contain warranty information and operating and maintenance instructions for the various appliances and components in your motorhome.

*NOTE: Many of the instruction sheets and manuals for the various appliances and components have been incorporated into the Operator's Manual Supplement for your convenience.*

*Please read the FAQ in Section 1 of the Operator's Manual Supplement for more details.*

Throughout this manual, frequent reference is made to the vehicle chassis manual that is provided by the manufacturer of the chassis on which this motorhome is built.

Consult the chassis manual for operating, safety, and maintenance instructions pertaining to the chassis section of the motorhome.

---

---

### SAFETY MESSAGES USED IN THIS MANUAL

Throughout this manual, certain items are labeled Danger, Warning, Caution, Notice, or Note. These terms alert you to precautions that may involve damage to your vehicle or a risk to your personal safety. Read and follow them carefully.

 **DANGER**

DANGER indicates a hazardous situation which, if not avoided, will result in death or serious personal injury.



## WARNING

WARNING indicates a hazardous situation which, if not avoided, could result in death or serious personal injury.



## CAUTION

CAUTION indicates a hazardous situation which, if not avoided, could result in minor or moderate personal injury.

## NOTICE

NOTICE is used to address practices not related to personal injury.

*NOTE: A “Note” is not necessarily safety-related, but indicates a recommendation or special point of information that could assist in understanding the use or care of a feature item.*

---

---

## PRE-DELIVERY INSPECTION

This motorhome has been thoroughly inspected before shipment. Your dealer is responsible for performing a complete pre-delivery inspection of the chassis and all motorhome components.

As a part of the pre-delivery inspection procedure, the dealer is responsible for road testing the motorhome, noting, and correcting any problems before delivery.

---

---

## FRONT AXLE TIRE ALIGNMENT

We recommend that you have the front suspension and steering alignment checked and adjusted after you have fully loaded the vehicle according to your needs. Thereafter, have alignment inspected periodically to maintain vehicle steering performance and prevent uneven tire wear.

---

---

## SERVICE AND ASSISTANCE

Your dealer will be glad to provide any additional information you need, as well as answer any questions you might have about operating the equipment in your coach. When it comes to service, remember that your dealer knows your vehicle best and is interested in your satisfaction. Your dealer will provide quality maintenance and any other assistance that you may require during your ownership of this vehicle.

If you need warranty repairs while traveling, you may take your vehicle to any authorized Winnebago Industries® dealership and request their assistance.

See the Service Dealer Directory in your InfoCase.

---

---

## REPORTING SAFETY DEFECTS

If you believe that your vehicle has a defect which could cause a crash or could cause injury or death, you should immediately inform the National Highway Traffic Safety Administration (NHTSA) in addition to notifying Winnebago Industries, Inc.

If NHTSA receives similar complaints, it may open an investigation, and if it finds that a safety defect exists in a group of vehicles, it may order a recall and remedy campaign. However, NHTSA cannot become involved in individual problems between you, your dealer, or Winnebago Industries®.

To contact NHTSA, you may either call the Vehicle Safety Hotline toll-free at:  
1-888-327-4236; (TTY: 1-800-424-9153)

or go to their website at <http://www.safercar.gov>  
or write to:

Administrator, NHTSA  
1200 New Jersey Avenue S.E.  
Washington, D.C. 20590

You can also obtain other information about  
motor vehicle safety from the NHTSA website  
at <http://www.safercar.gov>

---



---

## OCCUPANT AND CARGO CARRYING CAPACITY LABEL

This label is affixed in the driver’s area next to  
or near the Vehicle Certification Label. It  
contains vehicle occupant and cargo carrying  
capacity along with the number of seat belt  
positions in the vehicle. The label also provides  
the weight of a full load of water and advises that  
this weight, along with the tongue weight counts  
as cargo.

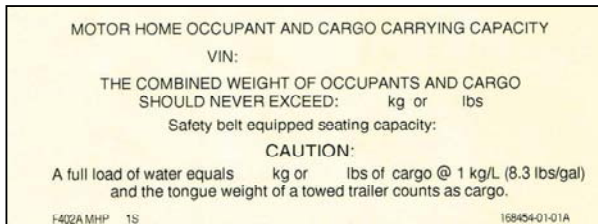

If any weight exceeding 45.4 kg (100 lbs.) is  
added to your coach between final vehicle  
certification and first retail sale, the occupant and  
cargo carrying capacity must be corrected and a  
label similar to the one shown below will be  
affixed inside your coach.



**VEHICLE CERTIFICATION LABEL**

This label is affixed to the lower driver side armrest panel, driver door, or the driver side door jamb, depending on model. It contains vehicle identification numbers and other important reference information.

MANUFACTURED BY WINNEBAGO IND. INC.	3	INCOMPLETE VEHICLE MANUFACTURED BY 1 GVWR 4 LB	2	KG
GAWR: FRT 5 LB KG RR LB KG	6	SUITABLE TIRE AND RIM CHOICE TIRE 7 RIM	8	COLD INFLATION PRESSURE PSI KPA 9 PSI KPA
THIS VEHICLE HAS BEEN COMPLETED IN ACCORDANCE WITH THE PRIOR MANUFACTURER'S IVD, WHERE APPLICABLE. THIS VEHICLE CONFORMS TO ALL APPLICABLE FEDERAL MOTOR VEHICLE SAFETY STANDARDS IN EFFECT ON THE DATE OF MANUFACTURE SHOWN ABOVE.				
SERIAL NO. 10 XXXXX XXXX XX XX/XX/XX XXX-XXXXX	VIN 11	TYPE 12 15	COLOR 13	XXXXXX-XXX

**EXPLANATION OF DATA**

1. Chassis manufacturer.
2. Chassis manufacture date.
3. Month and year of manufacture at Winnebago Industries®.
4. Gross Vehicle Weight Rating: Total permissible weight of the vehicle, including driver, passengers, total cargo carried (including all liquids), and equipped with all options.
5. Gross Axle Weight Rating: Total permissible weight allowed for the front and rear axles (listed in pounds and kilograms).
6. Suitable Tire Choice: Tires recommended to meet handling and safety requirements. When replacing any of the tires on your vehicle, always replace with a tire that meets these specifications.
7. Suitable Rim Choice: Wheel rims recommended to meet handling and safety requirements. When replacing any of the rims on your vehicle, always replace with a rim that meets these specifications.
8. Cold Inflation Pressure: Inflation pressures at Gross Axle Weight Ratings recommended (while cold) for the tires originally equipped on your vehicle. These pressure levels must be maintained to assure proper handling, safety, and fuel economy.
9. Rear Axle Wheel Configuration: Single or Dual as it relates to the inflation.
10. Serial Number: This is the serial number assigned to the completed vehicle by Winnebago Industries.
11. Vehicle Identification Number (VIN): This number identifies the chassis on which the motorhome is built. The 10th digit of the VIN designates the chassis model year. (C=2012, D=2013, etc.). This information is useful when ordering chassis repair parts.
12. Type: States the NHTSA designated usage classification for your motorhome. MPV signifies a Multi-purpose Passenger Vehicle.
13. Color: Signifies the color code number of the decor used throughout the vehicle. This number is necessary for ordering replacement cushions, curtains, carpet, etc.
14. Winnebago® model year and series/family name.
15. Model: Lists the Winnebago product model number of your vehicle.



**SPECIFICATIONS AND CAPACITIES**

Itasca Reyo	25Q	25R	25T
	Mercedes-Benz® F50 Chassis	Mercedes-Benz® F50 Chassis	Mercedes-Benz® F50 Chassis
Feature Number	1ME	1ME	1ME
Length	25' 5"	25' 5"	25' 5"
Exterior Height <sup>1</sup>	11'	11'	11'
Exterior Width	7' 6.25"	7' 6.25"	7' 6.25"
Exterior Storage <sup>2</sup>	39.0 cu. ft.	54.0 cu. ft.	92.0 cu. ft.
Awning Length	16'	16'	16'
Interior Height	6' 5"	6' 5"	6' 5"
Interior Width	7' 3"	7' 3"	7' 3"
Freshwater Tank Capacity <sup>3</sup>	28 gal.	27 gal.	28 gal.
Water Heater Capacity	6 gal.	6 gal.	6 gal.
Holding Tank Capacity - Black <sup>3</sup>	36 gal.	40 gal.	36 gal.
Holding Tank Capacity - Gray <sup>3</sup>	36 gal.	30 gal.	36 gal.
Propane Capacity <sup>4</sup>	13 gal.	13 gal.	13 gal.
Wheelbase	170"	170"	170"
GVWR	11,030 lbs.	11,030 lbs.	11,030 lbs.
GAWR - Front	4,410 lbs.	4,410 lbs.	4,410 lbs.
GAWR - Rear	7,720 lbs.	7,720 lbs.	7,720 lbs.
GCWR <sup>5</sup>	15,250 lbs.	15,250 lbs.	15,250 lbs.
Fuel Capacity	100 liter (26.4 gal.)	100 liter (26.4 gal.)	100 liter (26.4 gal.)

**Notes:**

All measurements are based upon the most recent data available. See your dealer for specifications.

<sup>1</sup> The height of each model is measured to the top of the tallest standard feature and is based on the curb weight of a typically equipped unit. The actual height of your vehicle may vary by several inches depending on chassis or equipment variations. Contact your dealer for further information.

<sup>2</sup> The load capacity of your motor home is designated by weight, not by volume, so you cannot necessarily use all available space when loading your motor home.

<sup>3</sup> Capacities are based on measurements prior to tank installation. Slight capacity variations can result upon installation.

<sup>4</sup> Capacities shown are the tank manufacturer's listed water capacity (W.C.). Actual filled propane capacity is 80% of listing due to overfilling prevention device on tank.

<sup>5</sup> Actual towing capacity is dependent on your particular loading and towing circumstances which includes the GVWR, GAWR, and GCWR as well as adequate trailer brakes. Refer to the chassis operator's manual of your motor home for further towing information.

**SECTION 1 –  
INTRODUCTION**



---

---

**OWNER AND VEHICLE INFORMATION**

**OWNER INFO**

Owner's Name(s) \_\_\_\_\_

Address \_\_\_\_\_

\_\_\_\_\_

**VEHICLE INFORMATION**

Motorhome Model Number \_\_\_\_\_

Motorhome Serial Number \_\_\_\_\_

Chassis Vehicle Identification No. (VIN) \_\_\_\_\_

Vehicle Mileage at Delivery \_\_\_\_\_

Selling Dealer Name \_\_\_\_\_

Address \_\_\_\_\_

\_\_\_\_\_

**YOUR WINNEBAGO INDUSTRIES® DEALER /SERVICE CENTER**

Name \_\_\_\_\_

Address \_\_\_\_\_

\_\_\_\_\_

Contact \_\_\_\_\_ Phone \_\_\_\_\_

**CHASSIS SERVICE CENTER**

Name \_\_\_\_\_

Address \_\_\_\_\_

\_\_\_\_\_

Contact \_\_\_\_\_ Phone \_\_\_\_\_

**RV INSURANCE POLICY**

Company \_\_\_\_\_

Policy Number \_\_\_\_\_

Agent \_\_\_\_\_ Phone \_\_\_\_\_



## SECTION 2 – SAFETY AND PRECAUTIONS

---

---

---

### GENERAL WARNINGS

- Only seats equipped with seat belts are to be occupied while the vehicle is moving.
- Make sure all passengers have seat belts fastened. Lap belts should fit low on the hips and upper thighs. The shoulder belt should be positioned snug over the shoulder.
- For pregnant women: Never place the shoulder belt behind your back or under your arm. Adjust the lap belt across your hips/pelvis, and below your belly. Place the shoulder belt across your chest (between your breasts) and away from your neck.
- Child restraints should be installed properly according to manufacturer's instructions. See "Child Restraints".
- All moveable or swiveling seats should be placed and locked in travel position while the vehicle is moving.
- Never let passengers stand or kneel on seats while the vehicle is moving.
- Sleeping facilities are not to be utilized while vehicle is moving.
- Examine the escape window and be familiar with its operation.
- Inspect the fire extinguisher monthly for proper charge and operating condition. This should also be done before beginning a vacation or any extended trip.

---

---

### DRIVING SAFETY

- Do not attempt to adjust the driver's seat while the vehicle is moving.
- Do not adjust tilt steering in a moving vehicle.
- Do not operate the cruise control on icy or extremely wet roads, winding roads, in heavy traffic, or in any other traffic situation where a constant speed cannot be maintained.

- Use care when accelerating or decelerating on a slippery surface. Abrupt speed changes can cause skidding and loss of control.
- Never drive the vehicle with a slideout room extended.
- Driving through water deep enough to wet the brakes may affect stopping distance or cause the vehicle to pull to one side. Check brake operation in a safe area to be sure they have not been affected. Never operate any vehicle if a difference in braking efficiency is noticeable.
- Adverse weather conditions and extremes in terrain may affect handling and/or performance of your vehicle. Refer to your chassis manual for complete and related information on driving your vehicle.

---

---

### FUEL AND PROPANE GAS

 **DANGER**

All pilot lights, appliances, and their ignitors (see operating instructions) shall be turned off before refueling of motor fuel tanks and/or propane containers. Failure to comply could result in death or serious injury.

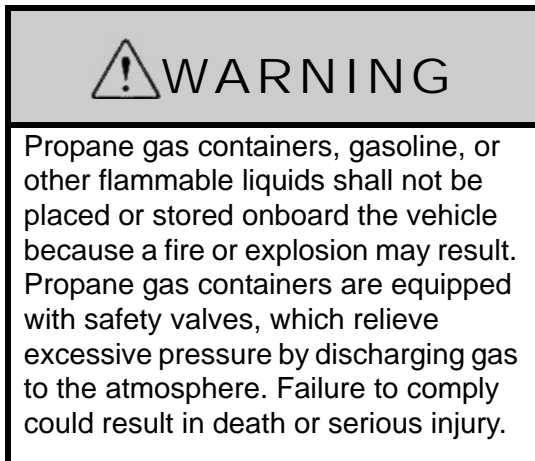

- All pilot lights must be extinguished and appliances turned off while refilling the fuel tank or propane gas tank.
- Never smoke while refilling vehicle fuel tank or propane gas tank.
- Never use an open flame to test for propane gas leaks. Replace all protective covers and caps on propane system after filling. Make sure valve is closed and the door is latched securely.
- Never connect natural gas to the propane gas system.
- When lighting range burners, **do not** turn burner controls to “On” and allow gas to escape before lighting match.
- Portable fuel-burning equipment, including wood and charcoal grills and stoves shall not be used inside the recreational vehicle. The use of this equipment inside the recreational vehicle may cause fires or asphyxiation.
- Propane gas regulators must always be installed with the diaphragm vent facing downward. Regulators are equipped with a protective cover. Make sure that the regulator vent faces downward and that the cover is kept in place to minimize vent blockage, which could result in excessive gas pressure causing fire or explosion.
- The following warning label is located in the cooking area to remind you to provide an adequate supply of fresh air for combustion.

Unlike homes, the amount of oxygen supply is limited due to the size of the recreational vehicle, and proper ventilation when using the cooking appliance(s) avoids dangers of asphyxiation. It is especially important that cooking appliances not be used for comfort heating, as the danger of asphyxiation is greater when the appliance is used for long periods of time. Failure to comply could result in death or serious injury.

---

---

## PROPANE GAS LEAKS

Check propane gas system for leaks yearly, or as necessary.

The following procedures are noted on a label, located in the vehicle near the range area. If you smell gas within the vehicle, quickly and carefully perform the procedures listed.

### IF YOU SMELL PROPANE

- Extinguish any open flames, pilot lights, and all smoking materials.
- Do not touch electrical switches.
- Shut off the gas supply at the tank valve(s) or gas supply connection.
- Open doors and other ventilating openings.
- Leave the area until odor clears.
- Have the propane system checked and leakage source corrected before using again.

Failure to comply could result in death or serious injury.

---



---

## PROPANE GAS LEAK DETECTOR

Your coach is equipped with a Propane Gas Leak Detector, similar to the one shown below. The leak detector sounds an alarm if an unsafe amount of propane gas is present inside the coach.



Propane Gas Leak Detector

### ! WARNING

**EXPLOSION HAZARD:** DO NOT use an open flame to test for gas leaks. When testing for gas line leaks with a soapy water solution, DO NOT use a detergent containing ammonia or chlorine. These substances may generate a chemical reaction causing corrosion to gas lines, resulting in dangerous leak conditions. Death or serious injury can result.

## Power Connection

The Propane Gas Leak Detector is powered by the house batteries. If the House/Coach Battery Disconnect switch is shut off or the battery cable is disconnected from the batteries, the alarm will not work. The Propane Gas Leak Detector fuse or circuit breaker is located in the 12-volt house electrical load center.

Because the Propane Gas Leak Detector is connected to the house battery, it is always drawing a small amount of current. Even though this current draw is slight, it could drain the house

battery during storage periods when the house battery will not be charged regularly by the engine or shoreline.

## Further Information

See the manufacturer's user guide provided in your InfoCase for further instructions.

---



---

## CARBON MONOXIDE WARNING

### ! WARNING

Avoid inhaling exhaust gases, as they contain carbon monoxide, which is a colorless, odorless, and poisonous gas. Death or serious injury can result.

The best protection against carbon monoxide entry into the vehicle body is a properly maintained engine exhaust and ventilation system. It is recommended that the exhaust system and body be inspected by a qualified motorhome service center:

- Each time the vehicle is serviced for an oil change.
- Whenever a change in the sound of the exhaust system is noticed.
- Whenever the exhaust system, underbody, or rear of the vehicle is damaged.

To allow proper operation of the vehicle's ventilation system, keep front ventilation inlet grill clear of snow, leaves, or other obstructions at all times. **DO NOT OCCUPY A PARKED VEHICLE WITH ENGINE RUNNING FOR AN EXTENDED PERIOD.**

Do not run engine in confined areas, such as a garage, except to move vehicle into or out of the area.

## SECTION 2 – SAFETY AND PRECAUTIONS



### CARBON MONOXIDE ALARM

Your coach is equipped with a Carbon Monoxide (CO) Alarm (located on the ceiling in the bedroom area.) The CO Alarm is powered by a 9-volt battery and has a sensor that is designed to detect toxic carbon monoxide gas fumes resulting from incomplete combustion of fuel. It will detect CO gas from any combustion source such as the furnace, gas range/oven, water heater, refrigerator, chassis engine, and electric generator engine.



Carbon Monoxide Alarm

 <b>WARNING</b>
Failure to replace this product by the "REPLACE BY DATE" printed on the alarm cover may result in death by Carbon Monoxide poisoning.

#### Replacement

When replacing this alarm, we recommend replacing only with the same model, or with one that is also listed for RV application. We recommend obtaining a replacement from your Winnebago Industries® dealer.

#### Further Information

Please read the information provided by the manufacturer, which is included in your InfoCase for further information.

### SMOKE ALARM

Your coach is equipped with a Smoke Alarm (located on the ceiling in the lounge area.) The Smoke Alarm is powered by a 9-volt battery and has a sensor that is designed to detect smoke.



Smoke Alarm

The following label is affixed to the Smoke Alarm.

 <b>WARNING</b>
<b>TEST SMOKE ALARM OPERATION AFTER VEHICLE HAS BEEN IN STORAGE, BEFORE EACH TRIP, AND AT LEAST ONCE PER WEEK DURING USE. FAILURE TO COMPLY MAY RESULT IN SERIOUS INJURY.</b>

#### Replacement

When replacing this alarm, we recommend replacing only with the same model, or with one that is also listed for RV application. We recommend obtaining a replacement from your Winnebago Industries® dealer.

#### Further Information

See the manufacturer's information in your InfoCase for further instructions.

---

---

## FIRE EXTINGUISHER

A dry chemical Fire Extinguisher is located near the main entrance door.



Fire Extinguisher  
(Typical installation - your coach may vary according to model and floorplan)

We recommend that you become thoroughly familiar with the operating instructions displayed on the side of the Fire Extinguisher and in the information supplied in your InfoCase.

We also recommend that you inspect the Fire Extinguisher for proper charge at least once a month in accordance with National Fire Protection Association (NFPA) recommendations as stated on the label.

If the charge is insufficient, the Fire Extinguisher must be replaced.

### NOTICE

Do not test the fire extinguisher by discharging it. Partial discharge can cause leakage of pressure or contents, which would render the unit inoperative when needed. When using the fire extinguisher, aim the spray at the base of the fire.

### Replacement

If for any reason you must replace the Fire Extinguisher, the replacement must be the same type and size as the one originally supplied in your coach. We recommend obtaining a replacement only from your Winnebago Industries® dealer or a reliable RV parts supplier.

---

---

## ELECTRICAL

- Careless handling of electrical components can be fatal. Never touch or use electrical components or appliances while feet are bare, while hands are wet, or while standing in water or on wet ground.
- Improper grounding of the vehicle can cause personal injury. Do not plug the utility power cord into an outlet which is not grounded and do not adapt the plug to connect to a receptacle for which it is not designed.
- Do not attach an extension cord to the utility power cord.
- Do not use any electrical device that has had the ground pin removed.
- Avoid overloading electrical circuits. Replace fuses or circuit breakers with those of the same size and amperage rating only. Never use a higher rated fuse or breaker.
- Use caution when handling or working near electrical storage batteries. Always remove jewelry and wear protective clothing and eye covering. Avoid creating sparks.

---

---

## LOADING

- Store or secure all loose items inside the motorhome before traveling. Possible overlooked items such as canned goods or small appliances on the countertop, cooking pans on the range, or free-standing furniture items can become dangerous projectiles during a sudden stop.
- Be aware of GVWR, GAWR, and individual load limit on each tire or set of duals (See “Loading the Vehicle” in *Section 12 - Miscellaneous*).
- Never load the motorhome in excess of the gross vehicle weight rating of the gross axle weight rating for either axle.

---

---

### MAINTENANCE

- Do not remove the radiator cap while engine and radiator are still hot. Always check coolant level visually at the see-through coolant reservoir.
- Never get beneath a vehicle that is held up by a jack only.
- Do not mix different construction types of tires on the vehicle, such as radial, bias, or belted tires, as vehicle handling may be affected. Replace tires with exact size, type, and load range.
- Refer to your chassis manual for complete maintenance precautions and recommendations.

---

---

### EMERGENCY EXITS

#### Escape Window

The bedroom escape window is secured by two red safety latches at the bottom of the window.

To open, lift both latches up and toward the center of the window, then push outward near the bottom of the window.

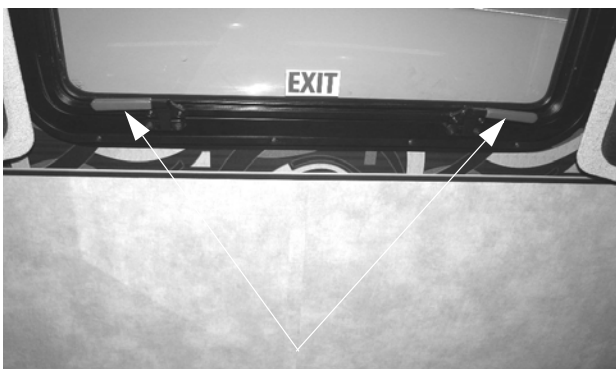

Escape Window  
(Lift latch handles upward  
and push window open)  
-Typical View

#### Using Slider Windows As Emergency Exits

Some coaches are required to have a slider window as an alternate exit. This window will be marked EXIT and have a red-handled latch.



Pull latch UP to slide window open  
-Typical View

Most slider windows along the side of any motorhome can also be used as alternate emergency exits, should the need arise.

To use a slider windows as an exit, first slide the window open, then either slide the screen open or push the screen material out, depending on window construction.

#### Escape Window (Optional)

##### -If Equipped

The bedroom escape window is secured by four safety latches at the sides and bottoms of each window.

To open, release all four latches and push window out.

1. Side Latches (2) - Pull down toward bottom of window frame.
2. Bottom Latches (2) - Pull toward the left-hand side of the window frame.
3. Push window open.



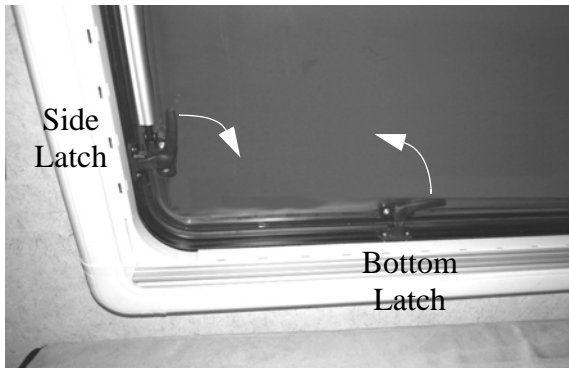

Escape Window  
(View of interior left-hand side of window)  
-Typical View

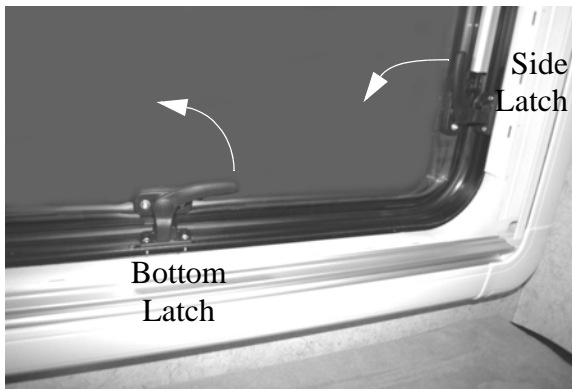

Escape Window  
(View of interior right-hand side of window)  
-Typical View

Check inside and outside the vehicle to make sure that there are no people who could be harmed or obstacles that could cause damage due to room activation.

 <b>WARNING</b>
<p>Keep all persons clear of the slideout room and moving parts while extending or retracting. Do not occupy the slideout room while it is being extended or retracted. Failure to observe can result in death or serious injury.</p>

---



---

## FORMALDEHYDE INFORMATION

Some of the materials used in this recreational vehicle emit formaldehyde. Eye, nose, and throat irritation, headache, nausea, and a variety of asthma-like symptoms, including shortness of breath have been reported as a result of formaldehyde exposure. Reaction to formaldehyde exposure may vary among individuals. Elderly persons and young children, as well as anyone with a history of asthma, allergies, or lung problems may be at greater risk. Research is continuing on the possible long-term effects of exposure to formaldehyde. Inadequate ventilation may allow formaldehyde and other contaminants to accumulate in indoor air. Ventilation to dilute the indoor air may be obtained from a passive or mechanical ventilation system. Always be sure to thoroughly ventilate your recreational vehicle before and during each use. High indoor temperatures and humidity may raise formaldehyde levels. When a recreational vehicle is in areas subject to high temperatures, an air conditioning system can be used to control indoor temperature levels. If you have any questions regarding the health effects of formaldehyde, consult your doctor or local health department.

---



---

## SLIDEOUT ROOMS

 <b>WARNING</b>
<p>Your motorhome may have more than one slideout room. Understand which switch operates which slideout room prior to operation. Make sure all slideout rooms are clear of people who could be harmed or obstacles that could cause damage prior to operating any slideout rooms. Failure to observe can result in death or serious injury.</p>

---

---

## **MOLD, MOISTURE, AND YOUR MOTOR HOME**

### **What is Mold?**

Molds are part of the natural environment. They are as old as the Earth itself and mold spores are almost everywhere at some level waiting to grow. Mold plays a part of nature by breaking down dead organic matter, such as fallen leaves and dead trees. Indoors however, mold growth should be avoided. Molds reproduce by means of tiny spores. Those spores are invisible to the naked eye and float throughout the outdoor and indoor air. Because of the nature of the use of a motorhome, it is natural for a motorhome to be introduced into an environment with mold spores.

Mold is a plant and requires its own special environment to grow. That environment includes organic materials, nutrients, moisture, and proper temperature.

### **How Can I Avoid Mold?**

To reduce the ability for mold to grow, you must reduce what constitutes its growth environment. Mold can grow with the smallest of a nutrient base. Just small amounts of dirt or dust on the carpet can be enough to allow the mold process to begin. Keep the environment as clean as possible. Vacuum the carpet. Clean food spills thoroughly and quickly. Avoid grease buildup near the stove or sink. Clean the exhaust fan above the stove often.

Minimize moisture in your motorhome and keep humidity low. Clean spills quickly. Do not allow condensation to build up. You can open windows and vents to minimize condensation. Use of the air conditioner can assist in removing moisture from the air. Avoid leaks, but if leaks do occur, make repairs promptly.

Avoid bringing mold into your motorhome. Plants, cloths, books, and other household items may already have mold present. It is easy to transfer mold into your motorhome environment.

Monitor your motorhome. Periodically check those hidden areas in corners, closets, and cabinets to assure mold is not present.

### **What if I Find Mold?**

If mold develops, clean the area with a concentrate of soap and bleach. Items that contain mold that cannot be cleaned should be removed from the vehicle.

### **Can Mold Harm Me?**

The effects of mold and airborne mold spores may cause irritation to some people. Experts disagree on the level of exposure that may cause health concerns.

### **If Mold Is Present, What Will Winnebago Industries® Do?**

If Winnebago Industries determines that mold is present in the Winnebago®/Itasca® motorhome as a result of a manufacturing defect reported to Winnebago Industries within the limited warranty period, Winnebago will clean the affected area(s) and/or replace affected items as it deems necessary. This is the extent of coverage provided by Winnebago Industries. Winnebago Industries, however, will not assume responsibility for mold deemed to be a result of a motorhome users lack of timely and appropriate action to mitigate circumstances should a problem occur.

If Winnebago Industries determines that mold is present due to conditions it determines is not a result of a manufacturing defect found within the warranty period, Winnebago Industries will not provide any financial assistance to the repair of the condition.

---

---

## **ROADSIDE EMERGENCY**

Because of the size and weight of this vehicle and its tires, and the possible complications involved in tire changing, we strongly advise obtaining professional road service to change a flat tire whenever possible. However, if an emergency requires you to change the tire

yourself, please exercise extreme caution and read all tire changing information in the chassis manual.

Never get beneath a vehicle that is held up by a jack only.

### If You Get A Flat Tire

- DO NOT panic.
- Grip the steering wheel firmly and steer the vehicle as straight as possible. Avoid quick maneuvers. You may need to counter-steer to compensate for “pull” created by the failed tire.
- DO NOT stomp on the brake. This abruptly shifts the vehicle’s weight forward, making it nose-dive and pull toward the blown-out side.
- DO NOT jerk your foot off the accelerator. Just ease back on the accelerator slowly and gently to continue momentum. The deflated tire will slow the vehicle.
- If you must change lanes to get to a safe stopping place, use your signals to warn other motorists and change lanes smoothly and carefully after you are certain the lane is clear.
- Let the vehicle coast to a stop, gently steering to a safe stopping place off the traffic lanes of the road. Do not worry about damaging the tire or wheel rim by driving on it. A tire or wheel replacement is cheaper than damaging the vehicle or injuring yourself.
- When you have come to a stop, activate your hazard flashers to warn other motorists, then exit the vehicle carefully.
- Set out flares or other warning devices.

Check your tires for proper inflation before each trip and at least once a month with an accurate tire gauge.

### Spare Tire Storage

If your coach is supplied with a spare tire, it is located in the rear storage compartment. Remove wing nut from inside tire rim and lift or slide tire out.

Some models, however, may have a swing-down spare tire carrier beneath the rear of the coach. Please follow all safety warnings and instructions for removing spare tire from the carrier.

### Swing-Down Carrier (if equipped)

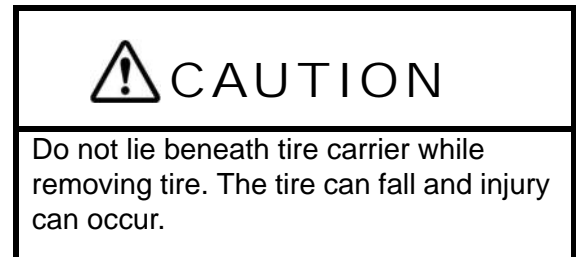

- Support tire carrier with a jack or block while removing wire pin and wing nut from bolt at back of carrier.
- Carefully lower tire carrier to ground.
- Lift or slide tire from carrier.
- Do not over-tighten wing nut when returning carrier to storage position.

### Recovery Towing

When calling a professional towing service, we recommend that you advise them of your coach length and approximate front axle weight listed on your Vehicle Certification Label. This will allow the towing operator to determine the proper towing equipment to use.

Winnebago Industries® does not assume responsibility for damage incurred while towing this vehicle.

*NOTE: Consult your chassis manual for towing instructions or precautions provided by the chassis manufacturer.*

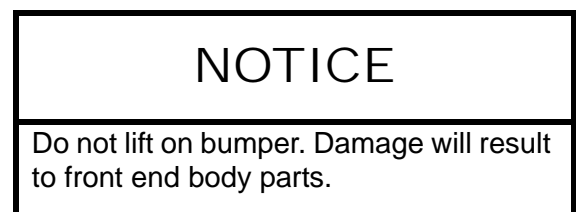

**! WARNING**

Stay out from beneath the motorhome while it is suspended by the towing assembly. Do not allow passengers to occupy a towed vehicle. Death or serious injury can result.

**WHEEL MOUNTING NUTS  
(LUG NUTS)**

The mounting bolts and nuts for the standard steel wheels are designed specifically for the type of wheel. See the following information and photos.

**Steel Wheels**

- The lug nut for steel wheels is a non-plated, hat-shaped, flange nut. The accompanying dome-shaped, split cone washer should be positioned ‘dome first’ onto the wheel stud before the nut as shown.



Steel Wheel Front

Steel Wheel Rear



Steel Wheel Lug Nut and Washer  
(Hex Flange Nut with Split Cone Washer)

**JUMP STARTING**

If your coach will not start from the chassis battery, try using the Battery Boost switch to divert power from the house batteries to the starter. (See “Battery Boost Switch” in *Section 3 - Driving Your Motor Home*).

If you wish to try jump starting the engine using another vehicle or booster system, see your chassis manual for connecting jumper cables to the automotive electrical system.

**NOTICE**

Do not attempt to push start this vehicle. Damage to the transmission or other parts of the vehicle will occur.

**ENGINE OVERHEAT**

If you see or hear steam escaping from the engine compartment or have any other reason to suspect an extreme engine overheating condition, pull the vehicle over to the roadside as soon as it is safe to do so, stop the engine, and get all passengers out of the vehicle.

**NOTICE**

Operating a vehicle under a severe overheating condition can result in damage to the vehicle.

For information on what to do in case of overheating, consult your chassis manual.

## SECTION 3 – DRIVING YOUR MOTOR HOME

---

The information in this section refers only to features installed or adapted to the dash and driver compartment area by Winnebago Industries®. It also includes passenger seating in the living area of the coach.

### Further Information

See the chassis manual in your InfoCase for all original chassis related controls, instrumentation, switches, and other features. This includes items such as cruise control, climate controls, gauges, wipers, lights, front seats, and three-point safety belts, etc.

---

### SEATS – DRIVER/CO-PILOT (CHASSIS SUPPLIED)

#### -If Equipped

The driver and co-pilot seats may be independently adjusted to suit individual preference.

### Further Information

See the chassis manual in your InfoCase for instructions on seat adjustments.

---

### SEATS – DRIVER/CO-PILOT (FLEXSTEEL)

#### -If Equipped

The Driver and Co-pilot Seats may be independently adjusted to suit individual preference.

To move the seat forward or backward, lift the slide release paddle (located on the outboard side of the seat) and exert slight body pressure in the direction desired.

The swivel/lift feature allows the seats to be turned toward the living area for additional seating while the unit is parked.

### Pedestal Lift Operation

#### Raising the Seat

1. Assure the ignition key is in the “Accessory” position and set the parking brake (refer to the chassis operating manual provided in your InfoCase).
2. Depress the Foot Pedal (located on the lower back of the seat) and press and hold the Activation switch (located on the back of the seat) UP simultaneously until seat lift motion stops.
3. Release Activation switch and Foot Pedal.



4. Remove key from ignition.

## SECTION 3 – DRIVING YOUR MOTOR HOME



### Rotating the Seat Toward Center of Coach

If you wish to rotate the seats toward the center of the coach for additional lounge/dinette seating, follow Steps 1-3 as previously listed and:

5. Grasp front of seat and rotate around so the seat is facing the lounge area, as desired.

### Lowering the Seat

1. Grasp front of seat and rotate to the forward facing position.

*NOTE: Seat must be facing forward before lowering. Failure to comply may result in damage to the seat.*

2. Assure the ignition key is in the “Accessory” position.
3. Depress the Foot Pedal and press and hold the Activation switch DOWN simultaneously until seat fully lowers and front lock tab is fully engaged (see supplied cab seat manufacturer’s information for further details).
4. Release Activation switch and Foot Pedal.
5. Verify that the front lock tab and the rear lock are properly engaged.
6. Release the parking brake.
7. Remove key from ignition.

*NOTE: A warning chime will sound if the seats are not locked in the forward facing position while attempting to start the vehicle.*



## WARNING

Assure seat is in its forward and locked position for travel. Do not adjust seat while vehicle is in motion. Failure to comply may result in injuries.

### Reclining the Seat

Lift UP on the Recline Lever (located on the side of the seat), lean back to desired incline, and release the lever. To return to the upright

position, lift UP on the Recline Lever and lean body forward. Allow the seat to return to the desired position and release the lever.

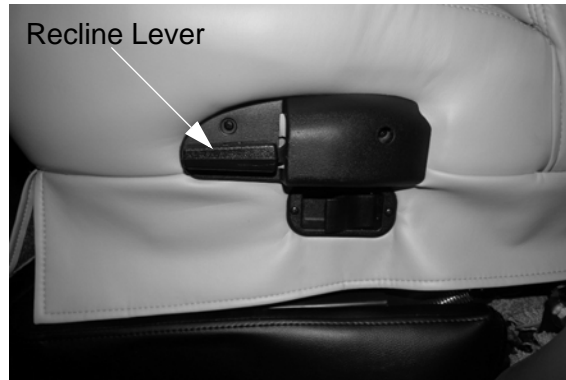

### Lumbar Support

Maintaining correct, ergonomic posture can help prevent back pain and discomfort, so sitting in a seat with good lumbar support is important.

A lumbar adjustment dial is located on the side of the driver and passenger seats to provide the travel comfort you need.



Lumbar Adjustment Dial  
(Located on the side of driver and passenger seats)

- Adjust dial by rotating for lumbar tension that best suits your comfort needs

---

## SEAT BELTS

Seats intended for occupancy while the vehicle is in motion are equipped with seat belts for the protection of the driver and passengers.

## Lap Belts

The lap belts must be worn as low as possible and fit snugly across the hip area. Always sit erect and well back into the seat. To gain full protection of the safety belt, never let more than one person use the same safety belt at any one time, and do not let the safety belts become damaged by pinching them in the doors or in the seat mechanism. After any serious accident, any seat belts which were in use at the time must be inspected and replaced if necessary.

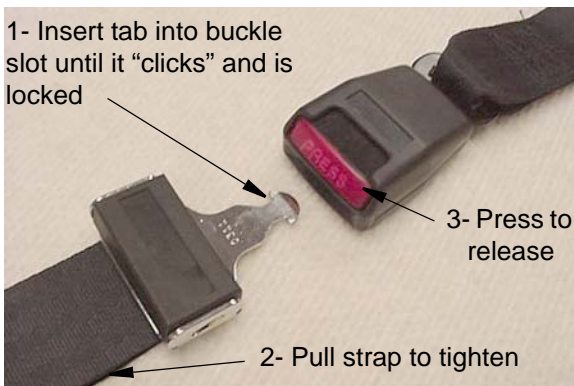

### Adjustment

To lengthen belt, swivel the tab end at a right angle to belt and pull strap to desired length. To shorten, pull loose end of belt.

### To Fasten

Be sure belt is not twisted. Grasp each part of the belt assembly and push tongue into buckle. Adjust to a snug fit by pulling the loose end away from the tongue.

### To Release

Press button in center of buckle and slide tongue out of buckle.

## ! WARNING

Snug and low belt positions are essential. This will ensure that the force exerted by the lap belt in a collision is spread over the strong hip area and not across the abdomen, which could result in serious injury.

Only seats equipped with seat belts are to be occupied while vehicle is in motion. Swivel seats must be in the locked, forward facing position while vehicle is in motion.

## Lap/Shoulder Belts

### Fastening

Hold the belt just behind the tongue. Next, bring the belt across the body and insert the tongue into the buckle until the latch engages.

### Unfastening

Press the release button in the buckle. Hold onto the tongue when you release it from the buckle to keep it from retracting too rapidly.

When the lap-shoulder belt is in use, the lap belt must ride low across the hip area and the shoulder belt must ride diagonally over the shoulder toward the buckle.

The shoulder belt is designed to lock only during a sudden stop, sudden body movement or a collision. At all other times it will move freely with the occupant.

## ! WARNING

Never wear the shoulder belt in any position other than as stated above. Failure to do so could increase the chance or extent of injury in a collision.

## Seat Belt Care and Cleaning

- Be careful not to damage the belt webbing and hardware. Take care not to pinch them in the seat or doors.

## SECTION 3 – DRIVING YOUR MOTOR HOME

Reyo

- Inspect the belts and hardware periodically. Check for cuts, frays, and loose parts. Damaged parts should be replaced. Do not remove or modify the belt system.
- Keep belts clean and dry. If the belts need cleaning, use only a mild soap and water solution. Do not use hot water. Do not use abrasive cleaners, bleach, or dyes. These products may weaken the belts.
- Replace any belt assembly that was used during a severe impact. Replace the complete assembly even if damage is not apparent.

---

---

### KEYS

Your motorhome is supplied with several keys. In addition to the chassis manufacturer's ignition key, you receive keys for the entrance door and exterior compartment doors.

Keys have an identification number, either a small metal tag or stamped into the key head. These numbers are recorded on the vehicle's component model/serial sheet, which is included in your InfoCase. In case keys are lost or stolen, your dealer or a locksmith can provide you with duplicate keys or modify the locks.

---

---

### REMOTE KEYLESS ENTRY

The main entry door on your vehicle is equipped with a Remote Keyless Entry system. If your coach is featured with a driver door, it also will be equipped with this system. Use the provided keyless remote transmitter to lock and unlock the entry door as well as the driver door (if equipped).

Make a habit of having the keys with you when you exit the vehicle and if opening the driver door (if equipped), first before opening the entry door whenever unlocking with the keyless remote.

---

---

### MIRRORS – POWER ELECTRIC –If Equipped

Always adjust mirrors for maximum rear visibility before driving off. Make sure the seat is adjusted for proper vehicle control and that you are sitting back squarely into the seat.

#### Mirror Adjustment Control

The mirror control is located on the driver side armrest panel or the dash. The ignition key must be on to adjust the mirrors.

Move Selector Switch L or R to select mirror. Center "neutral" position disables arrows to avoid unintentionally moving a mirror.

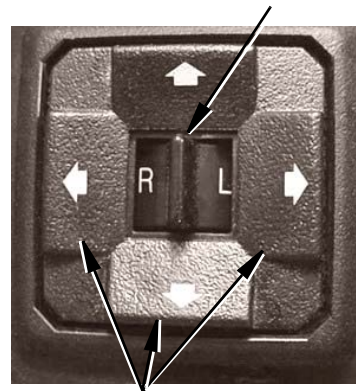

Press Arrow Buttons to move mirror surface in direction indicated.

#### Mirror Heaters

The mirrors may also contain heating elements to de-fog or de-ice the mirror glass during cold weather operation. A switch for the mirror heaters is located on the dash. To turn on, press the switch UP. Press DOWN to turn off.



Mirror Heat Switch  
(Located on dash)  
-Typical View



## Mirror Arm/Head Adjustment

If you cannot adjust a mirror properly using the control switch, the mirror may need a coarse adjustment by rotating the mirror head.



### Mirror Head Pivot Lock

- Loosen Allen head set screws to pivot mirror head.
- Torque 75-100 in./lbs.

*NOTE: Set screws may be located on the opposite side of the mirror arm. Passenger side mirror is similar.*

---

---

## POWER SUNVISOR

### -If Equipped

The Power Sunvisor is controlled by a switch located beneath the dash radio.

- To extend, Press and Hold the Power Sunvisor switch in the DOWN position.
- To retract, Press and Hold the Power Sunvisor switch in the UP position.

*NOTE: Do not position the visor where it will impair the driver's forward vision or side mirror views.*

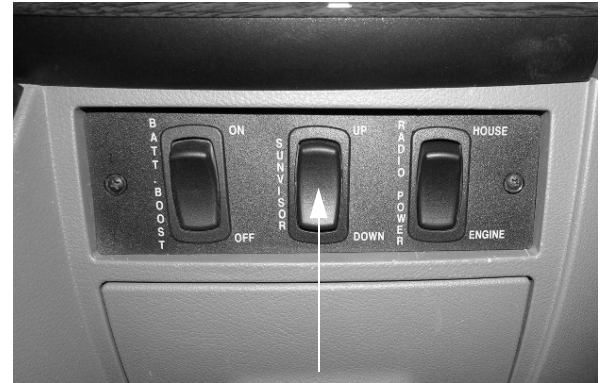

Power Sunvisor Switch  
(Located beneath dash radio)  
-Typical View

---

---

## HAZARD WARNING FLASHERS

The hazard warning flashers provide additional safety when the vehicle must be stopped on the side of the roadway and presents a possible hazard to other motorists. When the flashers are on, it serves as a warning to other drivers.

### Further Information

See your chassis manual for instructions on activating, operating, and canceling hazard warning flashers.

---

---

## AIR CONDITIONER/HEATER – AUTOMOTIVE (DASH)

See the chassis manual provided in your InfoCase for specific recommendations, operating instructions, and maintenance information.

*NOTE: The dash air conditioner is not designed to cool the entire interior of the coach, but is intended only to provide cooling for the cab area.*

### Accessing the AC/Heater Filter

The dash AC/heater is equipped with a disposable filter, which is located underneath the front hood. To access the filter:

1. Open the front hood.

## SECTION 3 – DRIVING YOUR MOTOR HOME

Reyo

2. Remove two screws on the front of the air filter housing.



Air Filter Housing  
(Located underneath the front hood)

3. Lift up air filter housing lid and replace filter.



*NOTE: To make removing the air filter easier, you may temporarily move the air intake hose by removing the fastener as shown in the following photo.*

*When finished replacing the filter, be sure to put air intake hose back in place and resecure the fastener.*

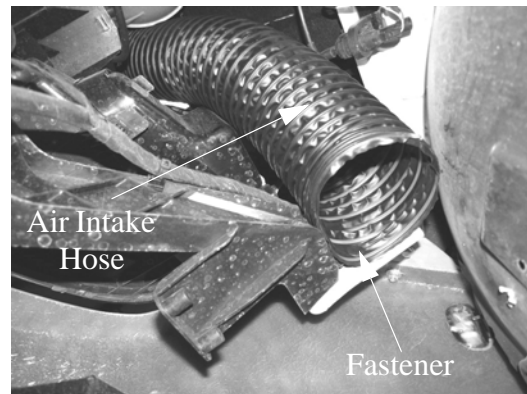

Air Intake Hose/Fastener  
(View shown from beneath  
the front end of coach)

---

## RADIO IN-DASH/REARVIEW MONITOR SYSTEM

### **–If Equipped**

The radio in your coach can receive AM/FM stereo and weather band stations. It also has a compact disc (CD) player for your listening enjoyment through quality high-output speakers located in several areas of the coach.

This system is also featured with a rearview camera monitor system, which lets you see what is directly behind your coach for safety and maneuvering assistance. The viewing screen is integrated into the dash.

The monitor screen “wakes up” automatically when transmission is shifted into reverse. A microphone built into the rear camera lets you hear warning sounds or verbal directions from an assistant.



## Basic Operating Instructions

- **POWER ON/OFF** - Push to turn ON or OFF. Push and Hold to turn screen OFF. Touch screen to turn back ON.
- **MENU** - Press to access USER SETTING MENU. Press and Hold to access SYSTEM SETUP MENU.
- **AUDIO** - Press and Hold to access AUDIO MENU. Press to return to current playback mode.
- **CAM** - Press to access CAMERA mode. Press and Hold to access CAMERA SETTINGS MENU.
- **MUTE** - Press to MUTE audio.
- **EJECT** - Press to EJECT CD.
- **DAY/NIGHT** - Press to switch between stored DAY/NIGHT user settings. Press and Hold to access AUTO DAY/NIGHT adjust.
- **AUX IN** - Connect portable audio player.
- **USB** - Connect a USB Jump Drive. NOT FOR IPOD CONTROLS.



## Sideview Cameras

### -If Equipped

The sideview cameras (built into the driver and passenger side mirrors) activate with the corresponding turn signals and replace the rear camera view on the monitor until the turn is completed or the signal lever is canceled manually.

## Satellite Radio

### -If Equipped

Your coach may be equipped with a Sirius® satellite radio receiver that plays through your radio.

See the receiver manufacturer's information in your InfoCase for programming and operating instructions.

## iPod Cable

### -If Equipped

Your coach may be equipped with a cable to connect your iPod to play through your radio. This cable is in the pocket located above the dash.

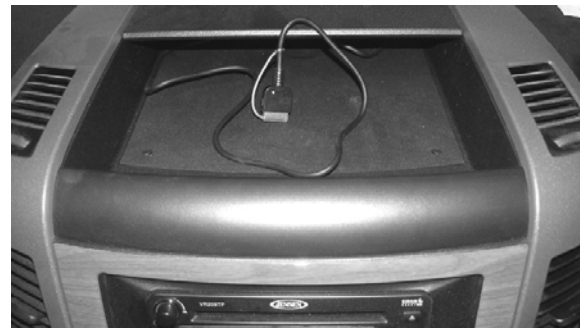

iPod Cable  
(Located in compartment above dash radio)  
-Typical Installation

See the manufacturer's information in your InfoCase for operating instructions.

## Radio Remote Controls

A hand-held remote allows the passenger to change radio stations or CD selections from the convenience of their seat. The hand-held radio remote is included in your InfoCase.

## Radio Power Switch

The Radio Power switch on the dash lets you connect the dash radio to the coach batteries when the ignition switch turned off for listening while parked. This prevents accidental draining of the chassis battery by prolonged use of the radio.

*NOTE: The House/Coach Battery Disconnect switch must be ON while listening to the dash radio, as the audio relay is powered*

## SECTION 3 – DRIVING YOUR MOTOR HOME

Revo

*by house batteries. If the House/Coach Battery Disconnect switch is OFF, the speakers will not emit sound.*

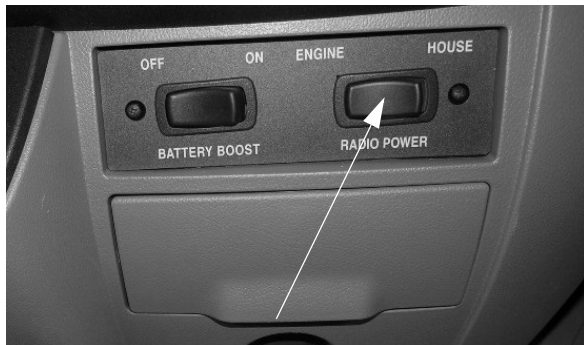

Radio Power Switch  
(Located on lower dash area)

- Press HOUSE to listen to the radio while parked without the ignition key on.
- Press ENGINE (“ENG”) to listen while driving.

### Further Information

See the manufacturer’s user guide provided in your InfoCase for complete operating instructions.

### INFOTAINMENT CENTER/GPS –If Equipped

The Infotainment Center in your coach is an all-in-one system that offers dash radio, rearview monitor, and GPS capability for your travel convenience.

This system also features Sirius® satellite radio, iPod and USB connections, and DVD player.

*NOTE: As a safety feature, this system will not play DVD’s unless the Parking Brake is set.*



Radio/GPS/Rearview Monitor  
(Located on dash)

### Basic Operating Instructions

Refer to the manufacturer’s owner manual and/or quick start guide provided in your InfoCase for a complete explanation of features and operating/set-up instructions.

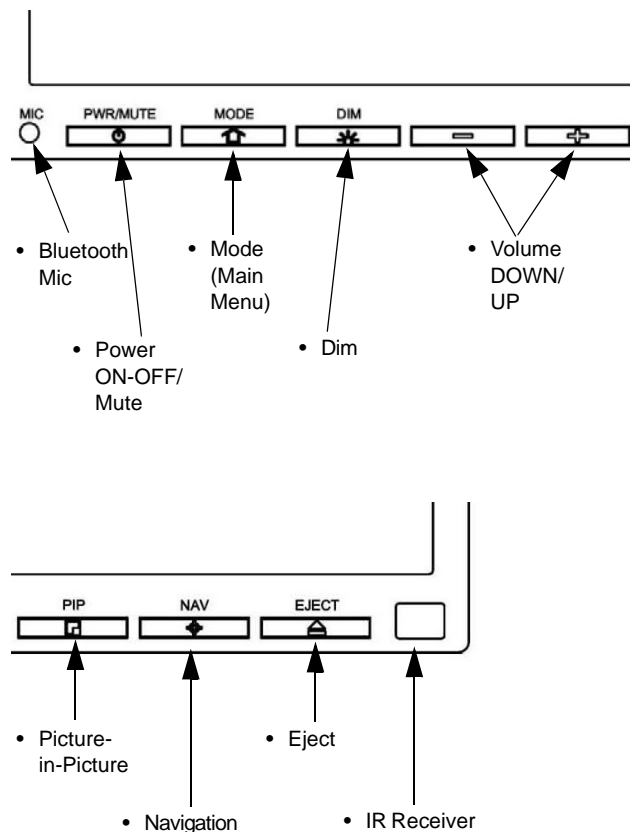

*NOTE: Your Infotainment Center is featured with an exterior thermometer. The temperature shown on the Infotainment Center display screen and the*

*temperature shown on the dash instrument panel may vary by up to three degrees.*

### Rearview Monitor

The rearview monitor feature of this system lets you see what is directly behind your coach for safety and maneuvering assistance. Sideview cameras also allow you to see what is beside you before turning or changing lanes.

The monitor automatically changes to camera mode when transmission is shifted into reverse. A microphone built into the rear camera lets you hear warning sounds or verbal directions from an assistant.

### Sideview Cameras

The sideview cameras (built into the driver and passenger side mirrors) activate with the corresponding turn signals and replace the rear camera view on the monitor until the turn is completed or the signal lever is canceled manually.

### GPS

The GPS navigation system can help you confidently chart your course through the most dense concrete jungle or remote country backroad using global satellite positioning technology.

Navigational information can be displayed on the monitor using either the monitor itself, or the remote control.



Dash Radio/  
GPS Remote

### Satellite Radio

Your coach is equipped with a Sirius® satellite radio receiver that plays through your radio.

See the receiver manufacturer's information in your InfoCase for programming and operating instructions.

### iPod Connection

Your coach is equipped with an iPod connection (located in the dash compartment above radio) to play your iPod through the dash radio.

### USB Connection

Your coach is equipped with a USB connection (located in dash compartment above radio) to connect items such as video game consoles, digital cameras, smartphones, printers, etc.

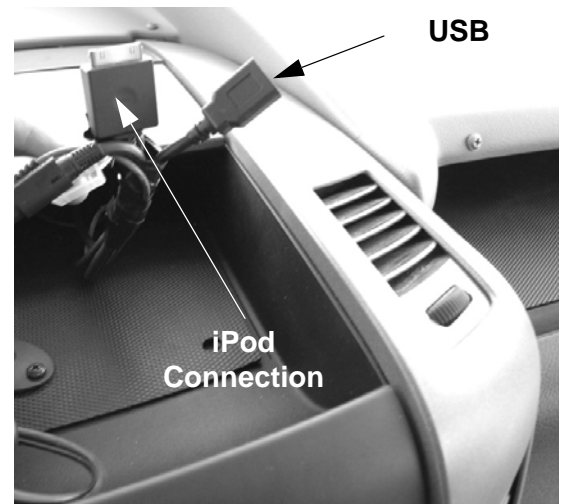

iPod/USB Connections  
(Located in dash compartment above radio)

### Radio Power Switch

The Radio Power switch lets you connect the dash radio to the coach batteries with the ignition switch turned off for listening while parked. This prevents accidental draining of the chassis battery with prolonged use of the radio.

*NOTE: The House/Coach Battery Disconnect switch must be ON while listening to the dash radio because the audio relay is powered by house batteries. If the House/Coach Battery Disconnect switch is OFF, the speakers will not emit sound.*

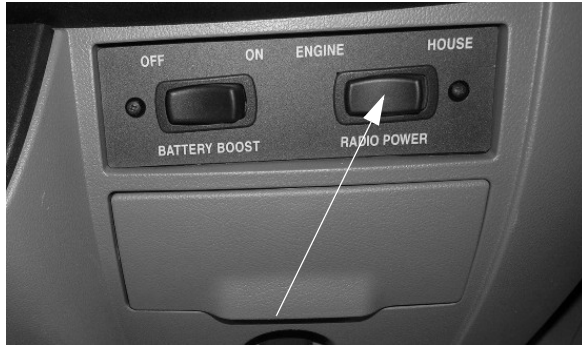

Radio Power Switch  
(Located on lower dash area)

- Press HOUSE to listen to the radio while parked without the ignition key on.
- Press ENGINE (“ENG”) to listen while driving.

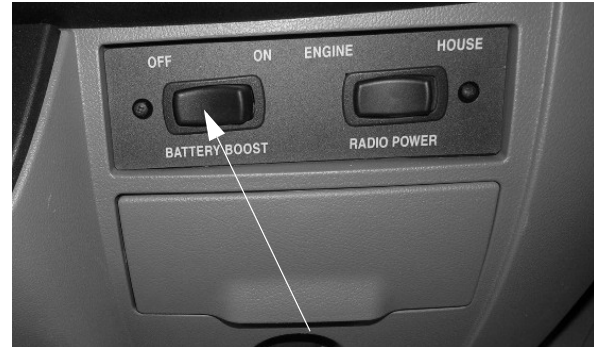

Battery Boost Switch  
(Located on lower dash area)

- Press and Hold in the ON position while turning ignition key for emergency starting power.

### Further Information

See the manufacturer’s user guide provided in your InfoCase for complete operating instructions.

---

---

### BATTERY BOOST SWITCH

The Battery Boost switch can be used to draw emergency starting power from the house batteries to start the engine if the chassis battery is discharged.

Press and Hold the Battery Boost switch in the ON position while turning ignition key for emergency starting power.

*NOTE: The House/Coach Battery Disconnect switch near the entrance door must be ON and house batteries must be sufficiently charged for this feature to work.*

---

---

### ENGINE COOLING SYSTEM

Do not remove the radiator cap while engine and radiator are still hot. Always check coolant level visually at the see-through coolant reservoir.

*NOTE: Your chassis engine cooling system is filled with special extended-life coolant that is not the same as common anti-freeze available at retail outlets. The coolant system MUST be refilled or topped up with the same type of coolant as equipped to maintain the special long-life properties.*

### Further Information

Refer to the chassis manual in your InfoCase for information and precautions on filling, servicing, and checking the fluid level.

---

---

### FUEL FILL ACCESS

The fuel fill access is located directly behind the driver side door on the exterior of the coach. Use the small round key (attached to your key ring) to unlock the fuel fill door.

- Insert key into lock turning counter-clockwise to unlock and open door.



- To close, lift up fuel fill door into closed position and turn key clockwise. Be sure the door is fully locked before traveling.

---

## DIESEL EXHAUST FLUID FILL

The Diesel Exhaust Fluid Fill is located under the front hood.

*NOTE: Use only certified diesel exhaust fluid (DEF) in the Diesel Exhaust Fluid Fill tank.*



Diesel Exhaust Fluid Fill  
(Located under front hood)  
-Typical installation shown

## Further Information

Refer to the chassis manual provided in your InfoCase for complete information and precautions.

---

## LIGHTS

All exterior lights should be checked for proper operation each time the vehicle is prepared for a trip. Any bulbs which fail to light should be checked and replaced, when necessary, with a new bulb of the same size. A failure of more than one light, such as both taillights not operating, may indicate a burned out fuse. Check fuse and replace with one of the same rating when necessary. If a fuse is not the cause of the problem, the wiring system should be checked immediately by an authorized service center.

## Further Information

Refer to the chassis manual in your InfoCase for further information.

---

---

**VALVE STEM ACCESS**

**(Mercedes-Benz® Sprinter Chassis)**

**Front Wheel Valve Stem Access on  
18-Hole Steel Wheel with Push-On  
Full Wheel Trim**

**–If Equipped**

1. Obtain a double angle push/pull truck tire gauge.



2. Locate the 6” hose extension (provided in your InfoCase).



3. Push the end of the hose extension onto the front wheel valve stem cap.



4. Using the hose extension as a remote handle, unscrew the valve stem cap (retaining cap in the end of the hose extension).
5. Adequate clearance is available to insert the tire gauge onto valve stem.



6. When tire pressure testing is complete, reinstall the valve stem cap (with the cap still retained in the hose extension end).
7. Remove hose extension from valve stem cap.

**Rear Inner Dual Valve Stem Access  
on 18-Hole Steel Wheel with Push-  
On Full Wheel Trim**

**–If Equipped**

1. Obtain a double angle push/pull truck tire gauge.



2. Locate the 6” hose extension (provided in your InfoCase).

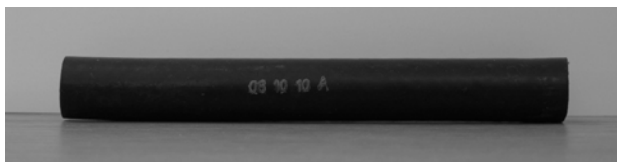

3. Push the end of the hose extension onto the rear inner dual valve stem cap.





- Using the hose extension as a remote handle, unscrew the valve stem cap (retaining cap in the end of the hose extension).

*NOTE: If the valve stem cap and valve stem extension unscrew as an assembly, pull the assembly out of the hose extension end, remove valve stem cap, insert extension into fuel hose, and reinstall extension onto valve stem until snug. Pull off extension hose and re-insert valve stem cap into end of hose.*

- To check inner dual tire pressure, use the long handle of the tire gauge to control alignment and avoid misaligned valve stem deflection.



- When tire pressure testing is complete, reinstall the valve stem cap (with the cap still retained in the hose extension end).
- Remove hose extension from valve stem cap.

### Rear Outer Dual Valve Stem Access

*NOTE: Rear Outer Dual is equipped with a fill-through extension (no valve stem cap).*

- Obtain a double angle push/pull truck tire gauge.



- To check rear outer dual tire pressure, use the long handle of the tire gauge to control alignment on the fill-through extension.



*(Shown without wheel liner for unobstructed view)*

---



---

## TIRES

Improper tire pressure can result in tire overloading and abnormal wear and also affects handling, ride characteristics, and fuel economy.



**WARNING**

Make sure all replacement tires are of the same size and rating as those shown on your Vehicle Certification Label.

---

---

## SUSPENSION ALIGNMENT AND TIRE BALANCE

The front suspension and steering system of this vehicle was factory aligned using highly accurate equipment prior to delivery to the dealership. However, alignment should be checked and adjusted after you have fully loaded the motorhome according to your personal needs. Thereafter, the alignment should be periodically inspected to help prevent uneven tire wear.

Any excessive or abnormal tire wear may indicate worn or misaligned suspension or steering, unbalanced tire, or other tire/suspension problem.

Alignment can be affected by worn steering/suspension parts or by incidents which happen during driving, such as hitting a curb, pothole, or railroad track, etc. Improper alignment can cause tires to roll at an angle and wear unevenly. It may also cause the vehicle to “pull” to the right or left. Have your dealer inspect your vehicle’s suspension and steering components periodically for misalignment or wear.

Out-of-balance tires will not roll smoothly and can lead to vibrations and uneven tread wear, such as cupping and flat spots. Tires may need to be balanced if uneven wear is detected or if ride comfort decreases noticeably.

### **Further Information**

See the chassis manual in your InfoCase for further information.

## SECTION 4 – APPLIANCES AND SYSTEMS

The appliances installed in your motorhome are manufactured by reputable RV appliance makers and have been tested by independent laboratories to meet all applicable standards and codes set for RV appliances.

See *Section 2 - Safety and Precautions* of this manual for any safety and precautions you need to take regarding the operation of your appliances.

### REFRIGERATOR

The refrigerator in your coach can operate from either of three energy sources available to the motorhome:

- 120-Volt AC Electric
- 12-Volt DC Electric
- Propane Gas

*NOTE: The 12V DC operation is only operational while the engine is running.*

To be able to use all energy sources, the refrigerator does not have a compressor like household refrigerators. Instead, it uses an ammonia-water solution for cooling. Basically, ammonia vapor is distilled from the solution by heat produced from either propane gas flame or electrical heat element. The ammonia vapor is then carried to the finned condenser where it liquefies. The liquid then flows to an evaporator where it creates cooling by evaporation. The ammonia circulates back into the water solution and the cooling cycle continues.

### Leveling

Before operating the refrigerator when the motorhome is stationary, place a small level on the bottom of the refrigerator and make certain the unit is level. If over 1/2 of the bubble is inside the circle in any direction, the coach is level enough for continuous operation of the refrigerator while parked.



Place bubble level in bottom of refrigerator

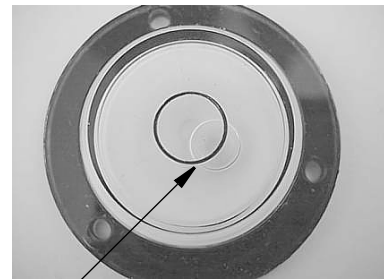

Bubble must be at least 1/2 inside circle

Normal vehicle leveling to provide comfort for the occupants is satisfactory for refrigerator operation.

### NOTICE

To prevent permanent damage to the refrigerator cooling unit, turn the refrigerator off if the vehicle will be parked on an incline of over 3° side-to-side or 6° front-to-rear (such as steep driveways or parking lots, etc.) for more than one hour.

### Basic Operation



## SECTION 4 – APPLIANCES AND SYSTEMS

Reyo

- To start up the refrigerator, press the Mode button for 2 seconds. The previously selected operating mode is displayed (e.g. 120, which means 120V).
- Press Mode again and you may change the operating mode to:  
**AU (Automatic Energy Selection)** or manually change to **120V, 12V, or Gas.**

*NOTE: The 12V DC operation is only operational while the engine is running.*

### AES Mode (Automatic Energy Selection)

When in this mode, the refrigerator electronics automatically selects one of the three energy types (120V, 12V, or Propane Gas). The control electronics automatically ensures that the refrigerator is supplied with the optimum source of energy in each case.

For more information on AES, please refer to your refrigerator operating instructions included in your InfoCase for complete details.

- **Temperature Setting** - Start at the “coldest” setting to ensure coldest temperature in the freezer compartment, then adjust warmer as necessary after cold\* food has been added.

*\* The refrigerator will retain temperature more efficiently if food is cold before placing inside.*

### Further Information

Refer to the appliance manufacturer’s user guide provided in your InfoCase for complete operating instructions, maintenance information, and safety precautions.

---

## REFRIGERATOR SERVICE ACCESS COMPARTMENT (Exterior)

The exterior refrigerator service compartment allows access to the rear of the refrigerator for inspection, maintenance, and service.

### To Open

1. Use a screwdriver or coin to turn the latch knobs to the vertical position.

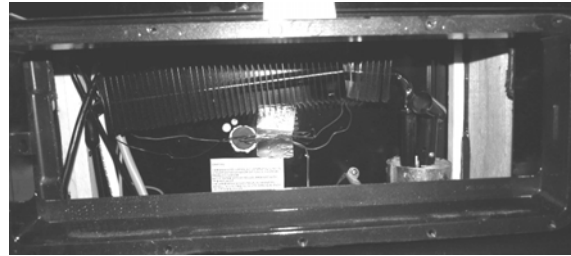

Refrigerator Access Compartment (Top)

2. Remove the door from the opening.

### To Close

1. Replace the door into the opening.
2. Push the latch knobs in while turning to the horizontal position.

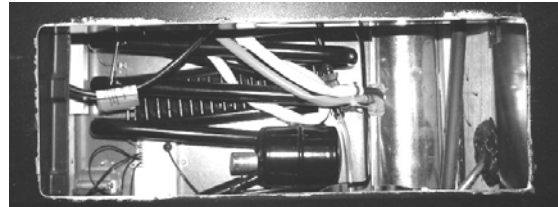

Refrigerator Access Compartment  
(Bottom)

---

## RANGE TOP

The range in your motorhome operates on propane gas and will provide most of the functions of the range in your home.



**To Light Range Top Burners**

- Push in desired control knob and turn to IGNITE position - and maintaining the knob pushed in, press down on the spark pump a few times to light burners.

**Avoiding Asphyxiation**

The following warning label has been located in the cooking area to remind you to provide an adequate supply of fresh air for combustion.

 <b>WARNING</b>
<p>IT IS NOT SAFE TO USE COOKING APPLIANCES FOR COMFORT HEATING</p> <p>Cooking appliances need fresh air for safe operation. Before operation:</p> <ol style="list-style-type: none"> <li>1. Open overhead vent or turn on exhaust fan.</li> <li>2. Open window.</li> </ol> <p>FAILURE TO COMPLY COULD RESULT IN DEATH OR SERIOUS INJURY</p>

Unlike homes, the amount of oxygen supply is limited due to the size of the recreational vehicle, and proper ventilation when using the cooking appliances avoids dangers of asphyxiation.

It is especially important that cooking appliances not be used for comfort heating, as the danger of asphyxiation is greater when the appliance is used for long periods of time.

**FAILURE TO COMPLY COULD RESULT IN DEATH OR SERIOUS INJURY.**

 <b>WARNING</b>
<p>Portable fuel-burning equipment including wood and charcoal grills and stoves, shall not be used inside the recreational vehicle. The use of this equipment inside the recreational vehicle can cause fires or asphyxiation. Failure to comply could result in death or serious injury.</p>

<b>NOTICE</b>
<p>Turn off the range and allow it to cool before closing the range cover. The range cover is made of glass and may shatter when heated.</p>

**Further Information**

Refer to the appliance manufacturer’s operation manual provided in your InfoCase for complete features and operating instructions, as well as safety precautions and maintenance information.

---



---

**MICROWAVE OVEN**

**-If Equipped**

Refer to the manufacturer’s user guide located inside the appliance for complete operating instructions.



Microwave/Convection Oven  
(Brand, model, and appearance shown  
may vary from your model)

---

---

## RANGE HOOD

### -If Equipped

The range hood vent draws cooking odors and airborne grease particles into the filtration grid and either recirculates the air or vents it to the outside of the coach, depending on model.

A light on the underside of the hood provides illumination for cooking and food preparation.

### Further Information

See the manufacturer's user guide provided in your InfoCase for instructions on replacement of light bulbs and replacement or cleaning of grease filter elements.

---

---

## ONEPLACE® SYSTEMS MONITOR PANEL

The OnePlace Systems Monitor Panel provides a convenient, central location for checking the condition of all utility systems in your coach.

At the touch of a button, the monitor panel will display the fresh water and holding tank levels, propane gas tank level, plus the chassis battery and house battery condition. You can start the generator and check the generator hourmeter or turn on the water pump and water heater.

## Generator Start/Stop Switches and Hourmeter

(Not available on coaches equipped with a diesel generator)

See *Section 6 - Electrical* for generator start-up/shut-down and generator hourmeter instructions.



Gen Start      Gen Stop      Gen  
Hourmeter

*Typical - Your coach may or may not be equipped with all of the features shown.*

## Water And Holding Tank Levels

Press the Tank Levels switch to show approximate levels on the LCD screen.



Tank Levels Switch

The approximate fluid levels are measured by electronic sensors on the sides of the tanks. Tank levels are displayed as 1/3, 2/3, and Full (F). There is generally more fluid in a tank than indicated on the monitor panel.

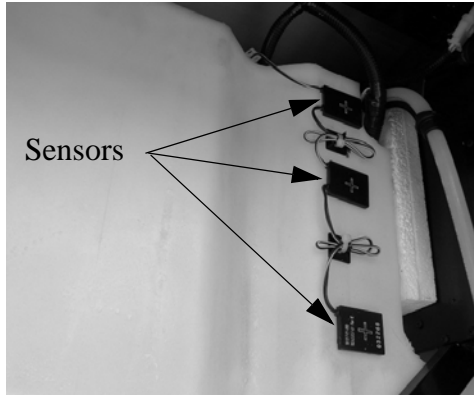

Water Tank  
-Typical View

**Tank Capacities**

See “Tank Capacities” in *Section 1 - Introduction*.

**Propane Gas Level**

Press the Tank Levels switch to show approximate propane tank level.

The propane level is registered by a sending unit on the tank. The gauge mounted on the side of the tank will give a more accurate indication of actual tank level if needed.

**Battery Charge Meter**

Press the Battery Levels switch to check the level of charge (voltage) in the chassis and house batteries.

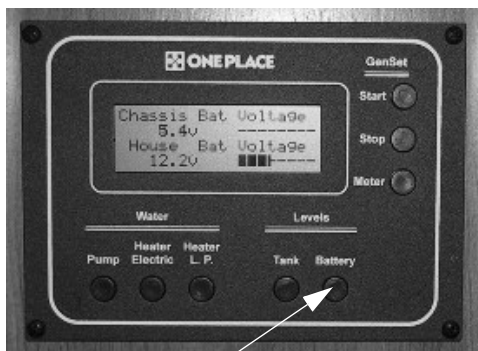

Battery Levels Switch

To get an accurate reading:

- Both the chassis engine and the generator engine must be shut off and 120-volt AC shoreline unplugged.

- An interior light should be turned on to provide a small load which draws off the battery surface charge.

**Water Heater Switches**

See Water Heater information elsewhere in this section for operating instructions.



Electric Water Heater Switch      LP Gas Water Heater Switch

**Water Pump Switch**

When use of the self-contained water system is desired, press the Pump switch (press once to get to the desired screen, and a second time to activate or deactivate.) Water will be available as soon as a faucet is opened.



Water Pump Switch

Refer to *Section 7 - Plumbing* for additional information on the water pump and initial start-up.

*NOTE: Some models may be equipped with a Water Pump switch in the water service center on the outside of the coach or within the bathroom area for your convenience.*

---

---

**WATER HEATER - GAS/  
ELECTRIC**

The Gas/Electric Water Heater has a dual power feature. It can operate from propane gas or 120-volt house current, or it can use both at the same time for quicker recovery at times when you are using a lot of hot water.

*See the Water Heater manufacturer’s operation manual provided in your InfoCase for complete operating instructions, safety warnings, and maintenance information before operating the Water Heater.*

**Be sure the Water Heater is filled with water before starting either electric or propane gas operation.** To fill the Water Heater, turn the Water Pump switch ON and open a hot water faucet anywhere in the coach. When water begins to flow steadily from the faucet, the Water Heater is full.

**For Propane Gas Operation**

Press the Water Heater LP switch to ON. The monitor panel display will indicate that the heater is “On”. If the monitor panel display reads “Water Heat LP Fail”, it means that the burner has gone into “lockout” mode and must be restarted. If this happens, turn the Water Heater LP switch off for about 5 minutes, then turn it back on.



**Propane Gas Water Heater Switch**  
(Located on OnePlace® monitor panel)

**For Electric Operation**

Press the Water Heater Electric switch to ON. The shoreline must be connected or generator running for electric operation.



**Electric Water Heater Switch**  
(Located on OnePlace monitor panel)

**For Quick Recovery Operation  
(Dual Heating)**

Turn ON both Water Heater switches - propane gas and electric. This will help reheat the Water Heater tank more quickly than a single source would alone. Use this mode when you are using a larger than normal volume of hot water.

**Further Information**

See the Water Heater manufacturer’s operation manual provided in your InfoCase for complete operating instructions, safety warnings, and maintenance information.

---

---

**PRESSURE-TEMPERATURE  
RELIEF VALVE**

On occasion, water may be seen seeping from the water heater pressure temperature relief valve. This is no cause for repair or replacement of the valve.



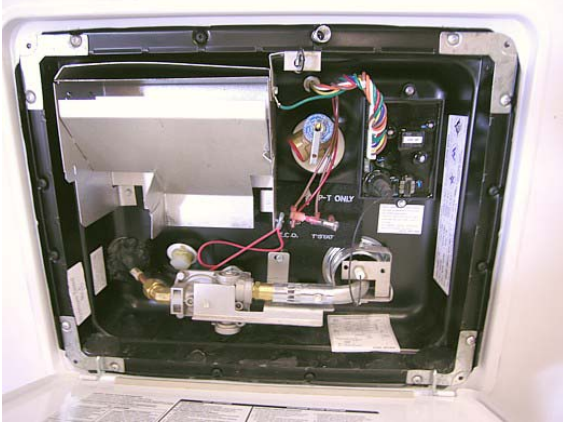

Water Heater Exterior Service Access

Normally there is an air gap at the top of the water heater tank, which acts as a pressure buffer. In time, however, heated water may expand and fill this air gap, causing a slight increase in water pressure. This may cause the P-T valve to “weep” until the air gap is manually replaced.

### CAUTION

Hot water can escape from tank causing injury. Operate this valve only when the water heater and engine cooling system are cold.

#### To Replace the Air Gap:

1. Turn off the Water Heater switch and incoming water supply (city water and/or demand pump).
2. Open a faucet in the motorhome to relieve water pressure.
3. Pull the handle of the P-T valve straight out and allow water to flow until it stops.

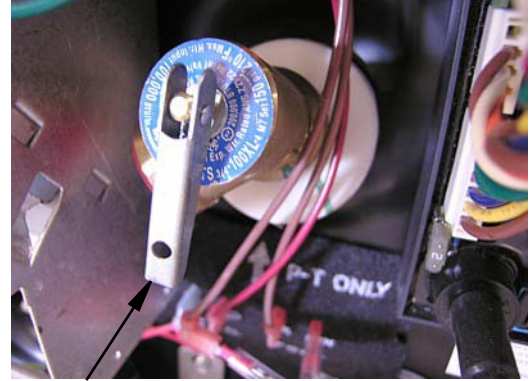

- Lift handle straight out to open P-T valve when water heater is cold

4. Let the handle of the P-T valve snap shut.
5. Close the faucet and turn on the water supply before switching the water heater on.

Manually operate the pressure temperature relief valve at least once a year.

*NOTE: If your water heater is equipped with the motoraid system, it uses an extension from the engine cooling system to heat water in the water heater while driving. The engine cooling system must also be cold before opening the pressure-temperature relief valve. See “Motoraid Water Heater” for more information.*

---

## PROPANE GAS FURNACE

### To Start Up

1. Open the Propane Gas Tank valve by turning fully “counter-clockwise”.



**Thermostat Switch**

- Move to Heat or Gas position for furnace operation

**Temp Selector**

- Press up or down to select temperature

-Typical View

2. Slide the Thermostat switch from Off to Heat and press the Temp Selector button (up/down arrows) until the desired temperature is shown on the display.
3. The furnace fan should start to blow immediately after setting the thermostat.
4. After approximately 30 seconds, the furnace burner should light.
5. The furnace should now cycle off and on automatically as the thermostat demands just like a household furnace.

*NOTE: If heat does not come out of the heat ducts after a minute or so, the burner is not lit.*

*Turn the thermostat off for 3-5 minutes, ensure Propane Gas Tank valve is open and tank is not empty, then repeat Steps 2-4.*

*If the furnace will not light after three attempts, go to “Shut Down” steps and contact your dealer or a local RV service center for repair.*

**To Shut Down**

1. Slide Thermostat switch to the Off position.
2. Close propane tank valve if coach will be stored for a period of time.

**Further Information**

Refer to the manufacturer’s user guide provided in your InfoCase for further information, including operating precautions, and periodic maintenance. See “Coach Maintenance Chart” in *Section 11 - Maintenance and Storage* for recommended intervals.

*NOTE: If the furnace burner has any residuals of metal protectant or lubricants used during manufacture of the furnace, it may smoke slightly when the furnace is used for the first time and may set off your smoke alarm.*

*We recommend that you provide adequate ventilation when using the furnace for the first time to avoid a nuisance smoke alarm.*

*We do not recommend removing the smoke alarm battery.*

---

---

**HEAT PUMP**

**-If Equipped**

Your coach may be equipped with an air source Heat Pump built into the air conditioning system. Because the Heat Pump operates on electricity, it provides economical heat inside your coach and helps reduce the use of propane gas for heating in cooler weather.

A Heat Pump can be thought of as an air conditioner running in reverse. An air conditioner absorbs heat from the air on the inside of the coach and moves it to the outside. The Heat Pump does exactly the opposite. Even cold air contains some heat, so a Heat Pump will extract heat from the outside air on a cold day and carry it to the inside of the coach to maintain a comfortable temperature.

The efficiency of a Heat Pump decreases as the outdoor air temperature drops, so supplementary heat is often needed when the outside temperature nears freezing. This system is set to automatically start the propane furnace to assist the Heat Pump if room temperature cools to five degrees or more below the thermostat set temperature. You may wish to manually switch to furnace heat to maintain a higher temperature

when outside temperatures begin to reduce the efficiency of the Heat Pump. The Heat Pump will not operate when the outside temperature falls below 36 degrees F.

### To Operate the Heat Pump

Refer to the manufacturer's user guide provided in your InfoCase for complete operating instructions.



- Gas Heat = Propane Furnace
- **Elec Heat = Heat Pump**
- Cool = Roof Air Conditioner

-Typical View

### Check Your Air Filter

Closed or blocked vents and a dirty air filter can hinder the efficiency of a Heat Pump.

- Ensure ceiling vents are open to distribute Heat Pump output air.
- The A/C return air filter should be checked monthly for dirt build-up and cleaned or replaced as needed. See “Air Conditioner Filter” elsewhere in this section.

*NOTE: The ducted roof air conditioning system has ceiling registers that can be closed if necessary to force more cool air toward a specific area of the coach or to route cool air away from a specific area. If too many vents are closed, however, it can cause the air conditioner unit to shut down, particularly in high humidity conditions.*

### Further Information

Refer to the manufacturer's user guide provided in your InfoCase for complete operating instructions.

---



---

### AIR CONDITIONER FILTER

The washable foam air conditioner filter is located in the ceiling-mounted return A/C grille in the lounge area of the coach.

It is recommended to check the filter monthly for dirt build-up and cleaned or replaced, as necessary.

---



---

### DUCTED ROOF AIR CONDITIONING SYSTEM

The furnace thermostat also controls ducted roof air conditioner operation when the Thermostat switch is placed in “Cool” position.

All cooling functions controlling to setpoint have a short cycle protection time delay of three minutes. There will be no delay if the cycle OFF time exceeds three minutes.



## SECTION 5 – PROPANE GAS

### PROPANE GAS SUPPLY

The propane gas system supplies fuel for the gas range/oven, water heater, furnace, and refrigerator (while in gas mode). When used and handled properly, this system is safe and economical and provides modern living conveniences wherever you travel.

See *Section 2 - Safety and Precautions* of this manual for other safety and precautions you need to be aware of related to propane.

### How Propane Gas Works

Propane is a type of LP (Liquefied Petroleum) gas compressed into liquid form for easy transportation and storage. Propane gas may also be called tank gas, bottle gas, or simply LP.

Propane is used by appliances in vapor form only, but is stored in the tank as a liquid under very high pressure. As the liquid gas is released, it reverts back to a vapor and expands to many times its compressed volume.

### Propane Tank System

The storage reservoir for the propane gas system is a horizontally mounted tank which is permanently attached to the vehicle frame. The tank is accessible only from the outside of the vehicle.

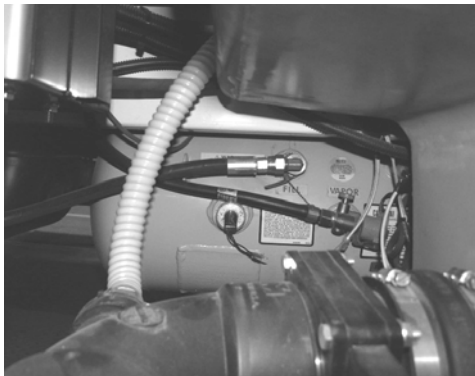

Propane Gas Tank  
(Located under center of coach)  
-Typical View

### WARNING

Do not alter or remove propane tank valves or gauge. Propane can escape, which can cause an explosion resulting in death or serious injury. Have the propane system serviced by a qualified service center.

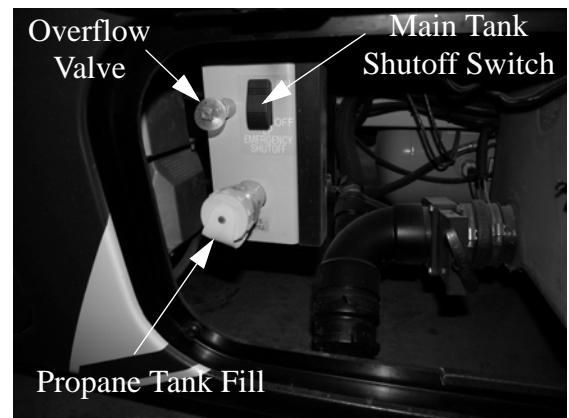

Propane Gas Access  
(Located in driver side compartment)  
-Typical View

### Main Tank Valve Switch

The main tank valve is located out of normal reach, so a switch is provided on the front of the tank compartment and on the monitor panel when you need to open or close gas flow from the propane tank.

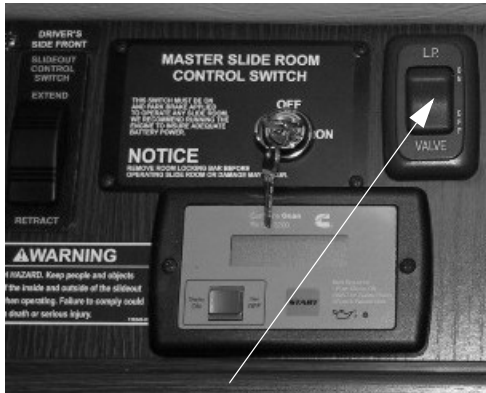

Main Tank Valve Switch  
(Located near monitor panel area)  
-Typical View



Main Tank Shutoff Switch  
(Located in driver side compartment)  
-Typical View

*NOTE: Both switches must be ON to allow propane supply to the coach. Propane gas flow can be stopped by turning either switch OFF. Turn switch OFF when propane gas supply is not needed to conserve house battery power.*

## Refilling Propane Tank

Since the propane tank is permanently mounted to the frame, the coach must be taken to a propane dealership for filling. Do not attempt to remove the propane tank from the vehicle. The tank is equipped with a fill adapter with both internal and external threads, which allows easy filling with any propane filling equipment. The tank is full when liquid propane gas appears at the overflow valve.

*NOTE: The propane tank is equipped with an automatic 80% stop-fill device.*

## DANGER

DO NOT FILL CONTAINER TO MORE THAN 80 PERCENT OF CAPACITY. FAILURE TO COMPLY COULD RESULT IN A FIRE OR PERSONAL INJURY. Make sure the motorhome is level when filling. It is possible to accidentally overfill the tank if the vehicle is not level, with the fill valve on the uphill side. Overfilling the propane gas tank can result in uncontrolled gas flow, which can cause fire or explosion. A properly filled container will contain approximately 80 percent of its volume as liquid propane gas.

**All pilot lights must be extinguished** and appliances and their ignitors turned off, and supply valve closed before refilling propane gas tanks or vehicle fuel tanks.

**Do not smoke or expose an open flame** while near a propane refueling area. Propane gas is heavier-than-air and extremely flammable.

**Never** fill the propane tank with engine or generator running.

Before opening the supply valve, check to be sure all controls for gas appliances are in the "Off" or "Pilot Off" position. If this step is not performed, propane gas could accumulate inside the motorhome creating a fire or explosion hazard.

**Never use an open flame** to test for propane gas leaks.

Replace all protective covers and caps on propane system before filling.

## Selecting Propane Fuel Types

We recommend using straight propane in your propane tank. Propane gas is commonly available at all propane gas outlets in the U.S. (According to the National Propane Gas Association, propane gas outlets in the United States do not offer any other type of liquefied petroleum gas than propane to the general public.) Check local

phone directory yellow pages for locations of local propane gas refilling stations or bulk dealerships.

*NOTE: If you travel outside the U.S. with your motorhome, you may find butane or propane/butane mixtures available in addition to propane. Because gas-burning RV appliances are designed to run on propane only, we recommend that you request straight propane only. Butane burns about 30 percent hotter than propane and can overheat some appliances, particularly refrigerators, and cause permanent damage. Other appliances designed to operate on propane can become sooted and lose efficiency by using butane fuel.*

### **Air in the Propane Gas Tank**

If your gas appliances do not stay lit or require frequent adjustment, even though you know the propane tank contains sufficient fuel, the problem may be air in the propane gas tank. Air in the tank mixes with the propane gas vapors causing them to burn poorly. This condition could linger for weeks if the air is not purged from the tank. Most propane gas dealers have equipment for purging air from propane gas tanks and will purge before refilling the tank.

---



---

### **SAFE USE OF THE PROPANE GAS SYSTEM**

The propane system is designed and built with strict adherence to national, state, and recreational vehicle industry requirements for mobile propane gas equipment.

For your safety, there are many safety devices and backup systems installed, such as tank fill overflow valves, an interior propane gas detector/ alarm, and an interior carbon monoxide (CO) detector/alarm.

Propane gas also contains an odor additive that you can smell if propane is present in the air.

Here are a few precautions to observe that will help you to use the propane gas system safely:

- Exercise caution at all times. Be familiar with the distinctive odor of propane gas. If a leak is suspected, turn off the supply valve immediately. Have the propane gas system checked by your dealer or other qualified propane gas service center.
- Do not tamper with the propane gas piping system, pressure regulator, or gas appliances. Service and maintenance of propane gas system components should be performed only by your dealer or a qualified propane gas service center.
- Never attempt to connect natural gas to the propane gas system.
- Have the entire propane gas system inspected for possible leaks and missing or damaged parts at each tank filling. Also inspect before and after each trip, and any time trouble is suspected.
- Turn the propane supply valve off when not using the propane gas system.
- Never use a wrench to tighten the tank supply valve. It is designed to close leak-tight by hand. If a wrench is required to completely close the valve, it is defective and must be replaced.
- Be sure appliance and outside vents are open and free from obstruction when using the propane gas system.
- Never attach a lock or any device requiring a key to the propane tank compartment door. According to standards set for recreation vehicles, the propane supply valve must be readily accessible in an emergency.
- Exercise caution when drilling holes or attaching objects to the walls. Gas lines and electrical wiring could be seriously damaged and present an extreme safety hazard.

---

---

## PROPANE GAS WARNINGS AND PRECAUTIONS

It is illegal for vehicles equipped with propane tanks to travel on certain roadways or through certain tunnels in the U.S. To avoid inconvenience, check state regulations concerning flammable gas transportation.

### Propane Gas Leaks

The following label is located in the vehicle near the range area. If you smell gas within the vehicle, quickly and carefully perform the procedures listed.

 **DANGER**

**IF YOU SMELL PROPANE**

1. EXTINGUISH ANY OPEN FLAME, PILOT LIGHTS, AND ALL SMOKING MATERIALS.
2. DO NOT TOUCH ELECTRICAL SWITCHES.
3. SHUT OFF THE PROPANE SUPPLY AT THE TANK VALVE(S) OR PROPANE SUPPLY CONNECTIONS.
4. OPEN DOORS AND OTHER VENTILATING OPENINGS.
5. LEAVE THE AREA UNTIL THE ODOR CLEARS.
6. HAVE THE PROPANE SYSTEM CHECKED AND LEAKAGE SOURCE CORRECTED BEFORE USING SYSTEM AGAIN.

FAILURE TO COMPLY COULD RESULT IN EXPLOSION RESULTING IN DEATH OR SERIOUS INJURY

- All pilot lights must be extinguished and appliances and their ignitors turned off while refilling the fuel tank or propane tank.
- Never smoke while refilling vehicle fuel tank or propane gas tank.
- Avoid inhaling exhaust gases produced by burned gasoline, diesel fuel, or propane gas in items such as the range, chassis engine, generator engine, refrigerator, furnace, and water heater. They contain carbon monoxide, which is an odorless, colorless, and poisonous gas.

 **WARNING**

Propane cylinders shall not be placed or stored inside the vehicle. Propane cylinders are equipped with safety devices that relieve pressure by discharging propane to the atmosphere. Failure to comply could result in death or serious injury.

- Never use an open flame to test for propane gas leaks. Replace all protective covers and caps on propane system after filling. Make sure valve is closed and door latched securely.
- Portable fuel-burning equipment, including wood and charcoal grills and stoves, shall not be used inside the recreational vehicle. The use of this equipment inside the recreational vehicle may cause fires or asphyxiation.
- Regulators are equipped with a protective cover. Make sure that the regulator vent faces downward and that the cover is kept in place to minimize vent blockage, which could result in excessive gas pressure causing fire or explosion.

---

---

## PROPANE GAS PRESSURE REGULATOR

The pressure regulator is protected from the elements by a plastic cover, which should be left in place at all times.

Propane regulators must always be installed with the regulator vents facing downward. Regulators that are not in compartments have been equipped with a protective cover. Make sure that the regulator vent faces downward and that the cover is kept in place to minimize vent blockage that could result in excessive propane pressure causing fire or explosion.

Only your dealer or a qualified propane gas service should remove the regulator cover for adjustments.



**! WARNING**

Visually inspect the pressure regulator vent periodically for blockage by accumulated debris or insect nests, etc. Vent obstruction could result in excessive pressure causing fire or explosion, which could result in death or serious injury. If an obstruction exists, have the regulator serviced by a qualified service center.

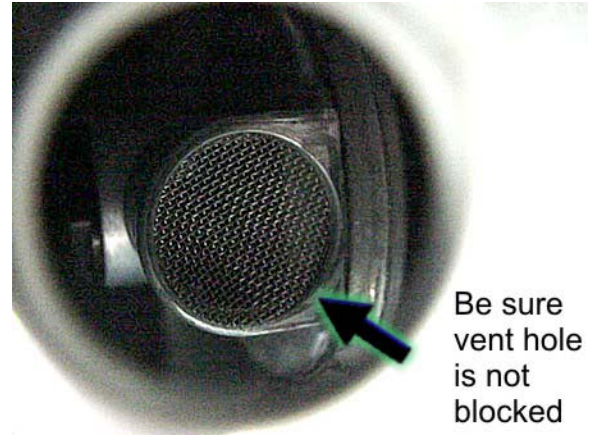

-Typical installation shown

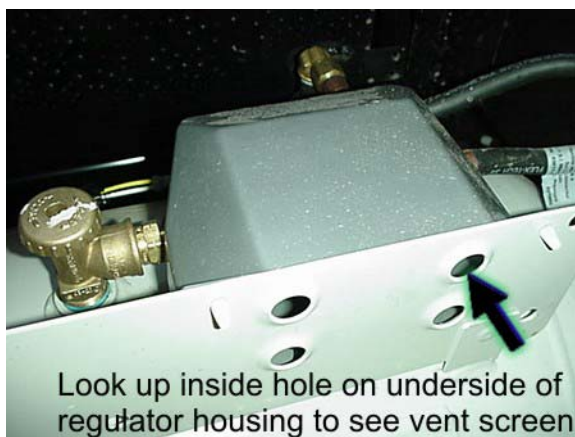

**Regulator Freeze-up**

Regulator freeze-ups are caused by the presence of moisture in fuel. This moisture will pass through the cylinder valve and into the regulator where it can freeze. Fuel producers, tank and bottle manufacturers, and propane gas dealers take every precaution to reduce moisture, but sometimes only a fraction of an ounce entering the tank can cause problems. To help avoid the possibility of freeze-up, always keep tank control valve closed when not in use, even when tank is empty, to prevent moisture from collecting on the inside.

If regulator freeze-up should occur, you may attempt to thaw the regulator using a light bulb. **DO NOT USE AN OPEN FLAME OR HEAT LAMP.**

If moisture begins to cause problems, have your propane gas dealer inject a small amount of dry methyl alcohol in your tank (approximately one ounce to 20 pounds or one pint to 100 gallons) to help guard against regulator freeze-ups.

**PROPANE VAPORIZATION IN COLD WEATHER**

Propane gas vaporization increases and decreases in direct relation to ambient temperature. In other words, the lower the temperature, the slower the liquid propane will vaporize into a usable gas for appliances.

## SECTION 5 – PROPANE GAS

---

Reyo

This means that in extremely cold weather when a large volume of gas is being used by the furnace for heating, it is possible to experience a loss of gas pressure.

At first, this problem may appear to be caused by an empty tank or a regulator freeze-up, but is actually caused by failure of the liquid gas to vaporize as fast as it is needed by the furnace.

The demand for propane to produce heat increases to the point where the gas cannot vaporize fast enough to keep the furnace going. The only solution to this problem is to reduce gas usage where possible.

Adjusting the temperature on the gas/electric refrigerator may be a first step. Using less hot water will also help, as well as refraining from using the gas cooktop. A final step is to lower the thermostat setting to reduce gas usage by the furnace.

## SECTION 6 – ELECTRICAL

Your coach is equipped with an electrical system consisting of two separate voltages:

- 12-volt DC system (battery current); and
- 120-volt AC system (household current)

The 12-volt system consists of two internal power sources, while the 120-volt system is operated from an outside power source or the optional 120-volt generator.

### ELECTRICAL CAUTIONS

- Careless handling of electrical components can be fatal. Never touch or use electrical components or appliances while feet are bare, while hands are wet, or while standing in water or on wet ground.
- Improper grounding of the vehicle can cause personal injury. Do not plug the utility power cord into an outlet which is not grounded and do not adapt the plug to connect to a receptacle for which it is not designed.
- Do not attach an extension cord to the utility power cord.
- Be sure that all electrical appliances to be used contain 3-prong plugs for proper grounding.
- Avoid overloading electrical circuits. Replace fuses or circuit breakers with those of the same size and amperage rating only. Never use a higher rated fuse or breaker.
- Use caution when handling or working near electrical storage batteries. Always remove jewelry and wear protective clothing and eye covering. Avoid creating sparks.

### ELECTRICAL SYSTEM – HOUSE 120-VOLT AC

The 120-volt system operates from the shoreline cord connected to an outside 120-volt utility service, such as those at campgrounds or from the 120-volt generator. When the shoreline cord is connected to an outside power source, or when the auxiliary electric generator is running,

the power converter automatically changes a portion of the 120-volt current to 12-volt DC current. All equipment in the motorhome that is normally powered by the house batteries is then powered through the converter.

In addition, the following equipment is entirely dependent on 120-volt current: air conditioner, refrigerator (when placed in AC mode), microwave oven, and any 120-volt electrical equipment used at convenience outlets.

### EXTERNAL POWER CORD (Shoreline)

 <b>WARNING</b>
<p>Do not use an extension cord. Improper sized cords, damaged cords, and poor connections can lead to fire, which can result in death or serious injury.</p>

 <b>WARNING</b>
<p>Do not connect the external power cord to any receptacle until you have verified proper polarity and grounding. Be sure all prongs of the supply cord are properly plugged into the receptacle. Failure to observe can result in death or serious injury.</p>

The external power cord (commonly referred to as a “shoreline”) is located in a compartment on the left (driver’s) side of the coach.

To connect to an external power source, remove the power cord from the utility compartment and plug it into a suitable power outlet box.

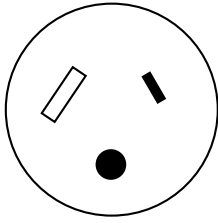

30 Amp Receptacle

The power cord is designed to ground the electrical system through the receptacle. It is also designed to carry the amperage output of most campground outlets. If the electrical receptacle to be used is designed to mate with the prongs of the power cord plug, the electrical connection can be expected to carry rated load.

**Power Cord Door  
(Models with power cord compartment on  
sidewall)**

**–If Equipped**

A flip-up notch in the power cord door lets you route the power cord out of the compartment and close the door while the power cord is connected.



- Swivel the cover section upward to access the cord notch



- Route power cord through notch and close door while shoreline is connected to outlet

**Power Cord QuickPort®  
(Models with power cord in utility  
compartment)**

**–If Equipped**

The flip-down QuickPort hatch lets you route the power cord out the bottom of the compartment so you can close the compartment door while the power cord is connected.



- Swivel the latch aside and drop the hatch



- Swivel cover section to access cord notch



- Route cord through notch and flip hatch back up into place and close the compartment door

*NOTE: Always keep service access passage closed while utility connection is not in use.*

### **Park Fuses or Breakers**

Most campgrounds are equipped with a fuse or circuit breaker at the receptacle (which we recommend shutting off before engaging or disengaging the power cord.) This protects the park’s wiring, as well as the power cord on your vehicle from electrical damage. If electrical power fails, contact the park attendants and have them check the fuse or breaker for your supply receptacle.

---

### **INVERTER UNIT – 1000W –If Equipped**

The inverter unit is located on the wall of the utility compartment.

*NOTE: The inverter is not intended for steady use while “dry camping”. Batteries will deplete quickly with use of the inverter. The inverter is intended for limited, short term power usage when not connected to shoreline or generator power. The inverter can also be used while driving the motorhome because the engine alternator will charge the batteries while driving.*



**Inverter Charger Unit**  
(Located inside utility compartment)  
-Typical View

## NOTICE

Do not store items too closely around the inverter unit in the storage compartment. The inverter generates heat while operating and needs unrestricted airflow for proper cooling. Damage to the inverter can result.

The inverter changes 12-volt DC battery power into 120-volt AC power for use by 120-volt AC equipment inside the coach.

*NOTE: Do not leave the shoreline plugged in during storage. Follow regular battery inspection and maintenance.*

### **Inverter Control Panel –If Equipped**

The inverter has a wall-mounted monitor/control panel. It will also display warnings for overload conditions or other operating failure conditions.



**Inverter Control Panel**  
(Located near monitor panel)  
-Typical View

When the inverter is not being used, it should be shut off at the control panel. The inverter could drain the house batteries if the shoreline is not connected to external power and the House/Coach Battery Disconnect switch is on.

**Further Information**

See the inverter control panel instructions in your InfoCase for complete instructions and charging setup directions.

---



---

**POWER CENTER**

**(Converter)**

The power converter is generally located in a lower cabinet face in the galley or living area, depending on the floorplan of your model.

The converter power panel contains the house electrical system 120-volt circuit breakers and 12-volt fuses.

The power converter changes 120-volt AC current from the auxiliary generator or the shoreline into 12-volt DC current for use by 12-volt equipment in the motorhome.

120-Volt  
Circuit Breakers      12-Volt  
House Fuses

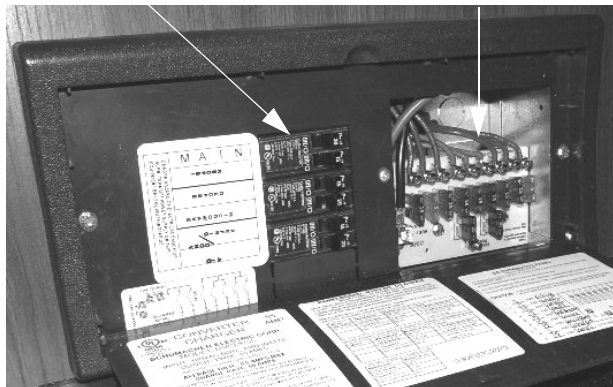

**Power Center (Converter)**  
-Typical View

Certain circuits, however, remain unchanged for use by items which require 120-volt current, such as the air conditioner(s), the refrigerator in AC mode, the microwave oven, etc.

*NOTE: The converter will not change 12-volt DC current to 120-volt AC.*

Current drawn from the house batteries passes through the power converter unchanged, although it is routed through a series of protective fuses located on the power panel.

**NOTICE**

Do not block the converter cover vents in any way. The converter generates heat while operating and needs unrestricted airflow for proper cooling. Damage to the converter can result.

**Further Information**

See the manufacturer’s operation, care, and maintenance information provided in your InfoCase.

**Charging Section**

The converter charges house batteries while 120-volt external power is connected. The converter will automatically “sense” the

condition of the battery. If it is below “full charge”, the Charging Section will start charging the batteries.

If the house batteries have been extremely discharged, they will accept charge at a relatively high amperage rate. If they are only slightly discharged, they will charge at a lower amperage rate. The rate of charge will decrease as the batteries reach “full charge”, then will continue “trickle” charging at a very low amperage rate. If your battery does not charge as described above, it is possible the battery is defective.

### Thermal Overload

A thermal overload will “break” the 120-volt AC power to the converter section of the Power Center if the power converter becomes overheated. This can result from operating above its maximum limit for an extended period of time or by obstruction of ventilation to unit.

*NOTE: The power converter section will automatically route 12-volt lights and motors to house battery power in this event.*

The thermal overload will reset itself after a period of time, and the lights and motors will again resume operation from the power converter section. If the breaker trips again shortly after reset, take immediate steps to correct the cause of overheating. A portion of the house 12-volt load (lights or motors or both) should be turned off to reduce total load. Also, inspect the power converter to make sure ventilation is not obstructed.

---



---

## CIRCUIT BREAKERS – HOUSE 120-VOLT AC

The breaker panel protects all 120-volt components in the motorhome from either an overload on the circuit or a short in the wiring or component itself. When an overload or short develops, the breaker will open preventing damage to the system.

Shut off the equipment (example: roof air conditioner) and allow a brief cooling period. Then reset the breaker by moving the switch to

“Off” and back to “On”. If the breaker is continually tripped and no overload is evident, have the system checked for a short in the wiring or the appliances.

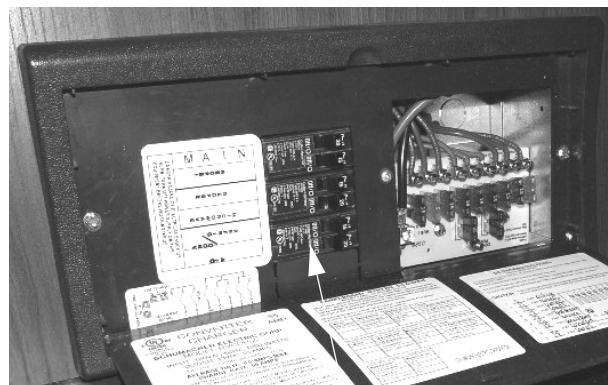

120-Volt Circuit Breakers  
-Typical View

*NOTE: Typical view of breaker panel. Breaker arrangement may vary according to appliance and equipment options. Fuses and breakers are labeled on panel.*

---



---

## ELECTRICAL OUTLETS – HOUSE 120-VOLT AC

A number of standard household electrical outlets are provided throughout the coach for connecting small appliances such as televisions, radios, toasters, etc.

An exterior outlet is also located on the outside of the coach near the entrance door or in a storage compartment on the passenger side of the coach.

---



---

## GROUND FAULT CIRCUIT INTERRUPTER

Bath, galley, and exterior outlets are connected to a GFCI (Ground Fault Circuit Interrupter), which is an extremely sensitive circuit breaker that will help to protect against severe electrical shock if a ground fault develops. If such a condition occurs, the GFCI will break the circuit by turning off the power to the protected outlets. Should this occur, unplug all the appliances on that circuit and press the reset button on the GFCI equipped outlet.

## SECTION 6 – ELECTRICAL

Reyo

If the GFCI keeps tripping, have the electrical system checked and repaired, if necessary, before using again.

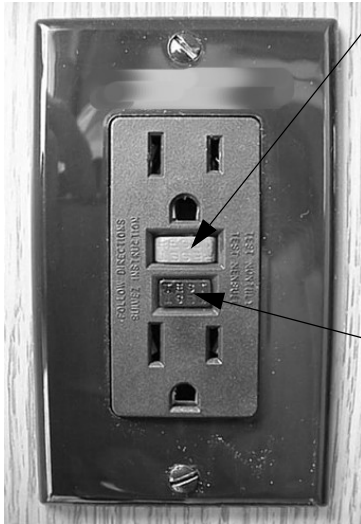

- Push to Reset circuit after monthly testing or ground fault tripping.
- Push to Test at least monthly. Should break circuit. Press Reset button to reconnect.

GFCI Outlet  
(Ground Fault Protector)

### WARNING

The GFCI will not completely eliminate the risk of electrical shock. Infants and small children may still be affected.

## ELECTRICAL GENERATOR – 120-VOLT

### WARNING

Careless handling of the generator and electrical components can be fatal. Never touch electrical leads or appliances when your hands are wet, or when standing in water or on wet ground. Do not attempt to repair the generator yourself. Service should be performed by a qualified service center.

To use the 120-volt Generator, plug the power cord into the Generator receptacle within the utility compartment before starting the Generator.

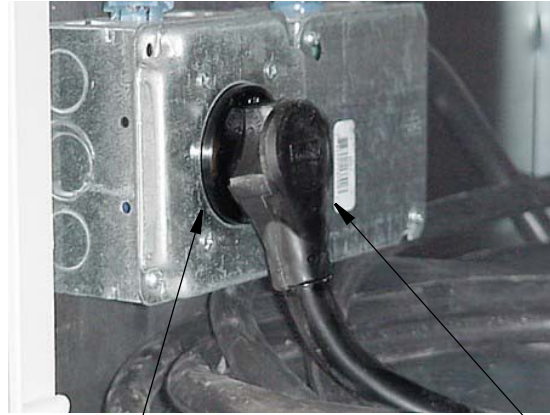

Generator  
Receptacle

Power Cord

### WARNING

Do not plug the power cord into the generator receptacle while the generator is running. Electrical shock can cause personal injury.

## Generator Basic Operation (LP Generator)

*NOTE: If the GenSet Start or Stop switch is momentarily pressed, the monitor panel will automatically try to start or stop the generator.  
Refer to the manufacturer's user guide provided in your InfoCase for additional information.*

### To Start the Generator

Press and Hold the GenSet Start button until you hear the Generator running smoothly, then release.

### To Stop the Generator

Press and Hold the GenSet Stop button until you hear the Generator come to a full stop, then release.





LP Generator Start/Stop Buttons  
(Located on monitor panel)  
-Typical View

**Generator Hourmeter**

The Generator hourmeter registers the total number of hours that the Generator has been operated. Press the GenSet Meter button once to get reading.

Refer to the hourmeter to determine when periodic maintenance is due and to record services which have been performed.



Generator Hourmeter Button  
-Typical View

**Generator Basic Operation  
(Diesel Generator)**

**To Start the Generator**

- Press the Display ON/Gen OFF button once to wake the Generator.
- Once “GEN OFF” appears on the display screen, press and Hold the Generator Start button until you hear the Generator running smoothly, then release.

**To Stop the Generator**

- Press the Display ON/Gen OFF button.



Diesel Generator Start/Stop Buttons  
(Located near monitor panel)  
-Typical View

The Diesel Generator display screen displays the Generator status, battery voltage, warning messages, and the total number of hours that the Generator has been operated.

Refer to the hourmeter to determine when periodic maintenance is due and to record services which have been performed.

**Operation Warnings and Cautions**

**! WARNING**

The exhaust of all internal combustion engines contains carbon monoxide (CO). This poisonous gas is colorless, odorless, tasteless, and lighter than air. The exhaust systems of both your motorhome engine and your generator engine have been installed with your safety in mind. However, certain precautions must be taken when using them to protect yourself from conditions beyond the control of the manufacturer.

- Do not simultaneously operate the Generator and a power vent, which could draw exhaust gases into the vehicle.
- Do not open windows or vents on the end or side of the vehicle where exhaust pipe of the Generator is located.

- Park the vehicle so that the wind will carry the exhaust away from the vehicle. Also, note the position of other vehicles to be sure their exhaust will not enter your vehicle.
- Do not operate the Generator engine while parked if vegetation, snow, buildings, vehicles, or any other object can deflect the exhaust under or into the vehicle.

Check Generator oil level frequently during periods of use. Refer to the Generator manufacturer's user guide provided in your InfoCase for specific recommendations.

### Further Information

Refer to the Generator manufacturer's user guide provided in your InfoCase for specific recommendations, operating instructions and cautions, troubleshooting, and maintenance.

---

---

## ELECTRICAL SYSTEM – HOUSE 12-VOLT DC

The DC voltage system consists of the chassis battery, the 12-volt house batteries, and the 12-volt power converter.

### Converter

See "Power Center."

### Chassis Battery

The chassis battery is used to operate the engine starter and automotive accessories and controls found on the instrument panel. The slideout room systems and the electric step are also connected to the chassis battery.

See your chassis manual for further information on chassis batteries and chassis electrical system.

### House Batteries

House batteries are "deep-cycle" type batteries specially designed for recreational vehicle use. They will provide longer lasting power than standard automotive starting batteries and will withstand the frequent drain-and-recharge cycles that occur under the demanding conditions of a camping outing.

The house batteries supply power to 12-volt equipment located in the living area of the motorhome. This includes the following 12-volt powered components (if equipped): interior 12-volt lighting, range exhaust fan, propane furnace fan, fresh water pump, systems monitor panel, refrigerator, roof vent fans, and 120-volt electrical generator starter.

The house batteries can also provide emergency power to start the engine if the chassis battery is discharged. (See "Battery Boost Switch" in *Section 3 - Driving Your Motorhome*).

House batteries are automatically charged by the chassis alternator while the engine is running.

---

---

## HOUSE/COACH BATTERY DISCONNECT SWITCH (COACH BATT)

The House/Coach Battery Disconnect switch lets you disconnect the house batteries from the 12-volt system of your coach during storage periods to avoid battery drain by electrical items that are hooked directly to the house batteries, such as clock displays and radio memories, etc.

Always leave this switch ON while using the coach.

*NOTE: Some electronic displays and memory functions may need to be reset after power has been reconnected.*

See also "Battery Care" elsewhere in this section.



House/Coach Battery Disconnect Switch  
(Located near entrance door or end of galley, depending on model)  
-Typical View

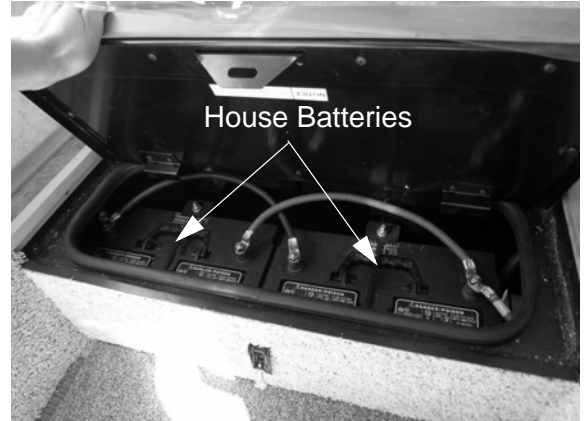

### Chassis Battery

The chassis (starting) battery is located in a compartment “well” in the floor beneath carpet ahead of the driver seat.

## BATTERY ACCESS

### House Batteries

The house batteries are located in a compartment beneath the interior entrance steps.

Unfasten the step retainer, then lift the step upward and remove to service batteries.



- Squeeze tab upward to release latch

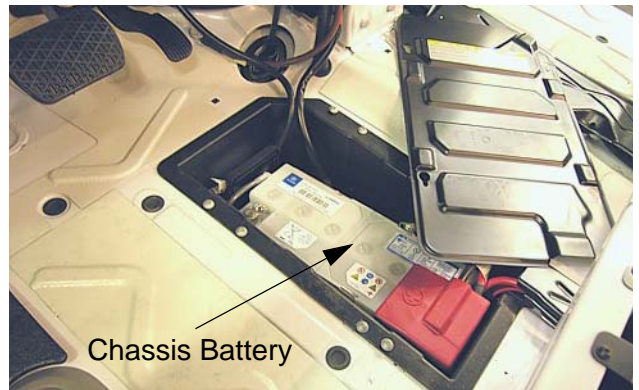

### Chassis Battery Connector

The chassis battery connector is located to the right of the accelerator pedal in the driver side foot well.

*NOTE: Ensure that the ignition key is in the Off position and the key is removed, and wait 10 minutes before disconnecting.*



**Chassis Battery Connector**  
(Located to the right of the  
accelerator pedal)

### **Further Information**

See the chassis manual provided in your InfoCase for details on access and servicing.

### **NOTICE**

Always refasten battery retainers when returning a battery to the compartment.

---

---

## **BATTERY CARE**

Lead-acid type batteries are electro-chemical devices for storing and releasing electrical charge. As such, they are simply an electrical reservoir, not an electrical source. As soon as energy is removed from the battery, it should be replaced by the engine alternator or the coach converter system.

If a battery sits unused for 30 days or more, especially during warm weather, it can develop a deposit of sulfate crystals on the metal plates inside the battery. This condition is called “sulfating” and prevents the battery from either releasing or accepting a charge. If this condition occurs, the battery must be replaced.

If a battery does not contain at least 80% charge during freezing temperatures, the electrolyte can freeze and crack the battery case.

### **The two best defenses against sulfating and insufficient charge are to:**

1. Turn off the House/Coach Battery Disconnect switch to avoid parasitic discharge (the trickle discharge caused by directly connected components like propane gas detectors or digital clock displays, etc.)
2. Check the battery and recharge as necessary at least once a month during long storage periods. Turn the House/Coach Battery Disconnect switch off to avoid electrical arcing when attaching or detaching charger clamps.

### **WARNING**

**California Proposition 65 Warning:**  
Battery posts, terminals, and related accessories contain lead and lead compounds, chemicals known to the state of California to cause cancer and reproductive harm. Wash hands after handling.

*NOTE: Do not leave the shoreline plugged in during storage. Follow regular battery inspection and maintenance.*

### **Further precautions are:**

- Check the state of charge periodically to avoid discharge or sulfating.  
To ensure that the battery will always accept and hold a charge, follow these simple maintenance practices:
- Make sure the batteries always remain securely clamped in the battery tray.
- Make sure battery cable clamps are tight on the terminal posts and are free of corrosion.
- Neutralize corrosion buildup or acid film on top of battery by washing with a baking soda/water solution. Rinse with clear water.

*NOTE: Make sure vent caps are on securely to prevent baking soda solution from entering the battery and contaminating the electrolyte fluid.*

**! WARNING**

Before removing any battery cables or battery, make sure all 12-volt equipment in the motorhome is off and the power cord has been disconnected. Be sure to replace the battery terminal boot, if supplied, back onto the positive terminal after servicing. Care must be taken to avoid pinching the cable between any metal parts. Should the cable be damaged, a short circuit could result in personal injury or damage to equipment. Replace any damaged cables at once. Always remove jewelry and wear protective clothing and eye covering when checking or handling batteries.

- Clean and tighten battery terminals and have the specific gravity checked at least once a year.
- Check the battery fluid level every month, or more often in hot weather. Fill to approximately 3/8 inch above the plates. **DO NOT OVERFILL.** If fluid is added during freezing weather, the motorhome should be driven several miles to mix water and electrolyte to prevent freezing.
- Fluid level check may be omitted if equipped with maintenance-free batteries.

**! WARNING**

To prevent wiring damage, it is essential when replacing the cables on the battery, or when using a “booster” battery, that the positive post and the positive cable be attached and the negative post and negative cable be attached. The posts are marked (+) plus and (-) minus. If a “boost charger” is used while battery is in the motorhome, disconnect both battery cables before connecting the charger to avoid damage to engine electronic components. Never attempt to charge or boost a frozen battery. An explosion can occur resulting in personal injury.

**Chassis Battery**

If your coach is going to be unoccupied for two weeks or more, Winnebago Industries® recommends disconnecting the chassis battery in your coach to avoid battery discharge.

Unplug the Chassis Battery Connector (located to the right of the accelerator pedal) to disconnect battery.

---

---

**CIRCUIT BREAKERS AND FUSES – HOUSE 12-VOLT DC**

All 12-volt circuits and equipment in the coach area of the motorhome are protected by either a fuse panel or breaker panel. When a circuit is overloaded or a short develops in any part of the system, a fuse or breaker will shut down that circuit. If this happens, turn off all affected lights or appliances and reset the breaker or replace the fuse with a new one of equal amperage rating.

**House 12-Volt Fuses**

The fuse panel is on the right-hand side of the Power Converter.

A label on the panel states the amperage rating and circuit protected for each breaker.

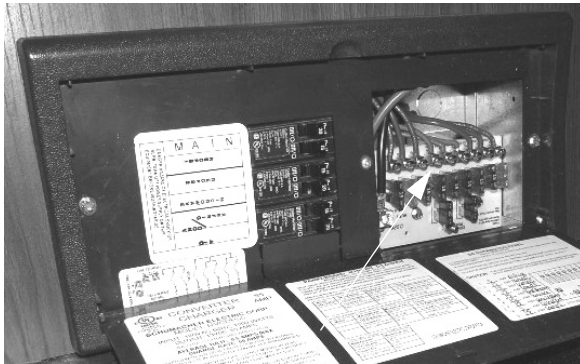

House 12-Volt Fuses  
(Located on right-hand  
side of Power Converter)  
-Typical View

The fuse panel accepts only blade type plug-in fuses. Always replace fuses with those of the same amperage rating.

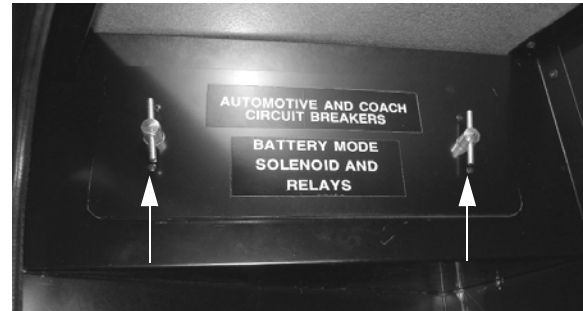
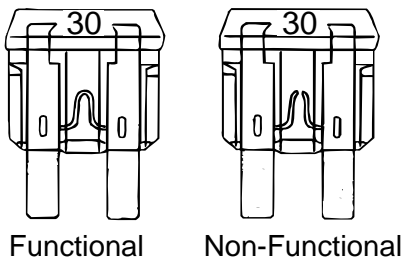

Automotive Chassis and House  
12-Volt Circuit Breakers  
(Located in passenger side compartment)  
\* Turn latches to remove cover



Automotive Chassis and House  
12-Volt Circuit Breakers  
\* Shown with cover removed

### Battery Charge Meter

See related item under “Systems Monitor Panel” in *Section 4 - Appliances and Systems*.

### Battery Boost Switch

See *Section 3 - Driving Your Motorhome* for information on the Battery Boost switch.

### Automotive Chassis and House 12-Volt Circuit Breakers

A label on the Automotive Chassis and House 12-Volt Circuit Breaker panel states the amperage rating and circuit protected for each breaker.

*NOTE: Breakers are labeled on panel.*

*Arrangement may vary according to appliance and equipment options.*

## SECTION 7 – PLUMBING

### FRESH WATER SYSTEM

The Fresh Water System provides water to the galley sink, shower, bathroom lavatory, toilet, and water heater. Water may be supplied by either of two sources:

- A fresh water tank and water pump located within the motorhome, or
- Any external fresh water source to which the motorhome may be connected, known as “city water”.

There are two ways to fill the fresh water tank on your coach - City Fill or Gravity Fill.

### Water Pressure Regulators

Because city water pressure varies from location to location, we recommend obtaining an in-line water pressure regulator to prevent damage to any components, connections, and seals in your fresh water system.

These devices simply connect in-line between the supply hose and the city water input on the coach. We recommend regulators that control water pressure to **50 psi. max.**

Water pressure regulators are commonly available at most RV dealerships and many large retail discount or home supply centers.

### Method 1 - Filling the Fresh Water Tank Through City Fill Connection

Always fill the fresh water tank at an approved potable water filling facility or a known purified drinking water source.

The tank is filled through the City Water Connection (Fresh Water Inlet) located inside the water service center.

The Fresh Water valve (located in the water service center) routes the water from the city water hose to the fresh water tank for filling.

1. Attach hose to the Fresh Water Inlet.



Fresh (City) Water Connection  
“Fresh Water Inlet”  
(Located in the water service center)

2. Open the Gravity Fill door (located behind a small, lockable door on the driver or passenger sidewall - depending on model) to aid in tank venting and as an overflow when the tank is full.



Water Tank Gravity Fill  
-Typical View

3. Turn the Fresh Water valve to the Tank Fill position.



Fresh Water Valve  
(Located in water service center)



Fresh Water Valve  
(Located in water service center)

4. Turn city water supply ON.
5. Use the level display on the monitor panel to oversee filling of the tank, or when the tank is full, water will flow from tank vent tube beneath coach and out of the Gravity Fill door.

<h2>NOTICE</h2>
Do not leave fresh water connection unattended when filling tank. Failure to comply may result in tank expansion and property damage.

6. Turn OFF city water supply and disconnect hose from the Fresh Water Inlet.
7. Turn the Fresh Water valve to Normal position to use the water pump. *The Tank Fill position is only for pressure filling the water tank from the city water hose connection.*

### Using City Water

When connected to an outside source of water, the water bypasses the water pump and storage tank and supplies pressure directly to individual faucets and toilet. A check valve built into the pump prevents water from entering the pump and filling the storage tank.

- Connect hose to Fresh Water Inlet as described in previous steps.
- With the Fresh Water valve in the Normal position, turn the Water Pump switch(es) OFF.

*NOTE: Always keep the Fresh Water valve in Normal position unless you are filling the tank. If this valve is left in the Tank Fill position while using the city water, water will keep flowing into the tank and out the tank vent tube onto the ground and the water pump will run without delivering water to the faucets.*

### Disconnecting from City Water

- Turn the city water supply OFF.
- Open a faucet on the coach (such as the exterior wash station, if equipped) to relieve line pressure.
- Disconnect hose from the coach and replace cap on the Fresh Water Inlet.



*NOTE: Ensure the Fresh Water valve is in NORMAL position to use the water pump. If the valve is in Tank Fill position, the pump will run continuously without delivering water.*

**Method 2 - Filling the Fresh Water Tank Through Gravity Fill**

**-If Equipped**

Always fill the fresh water tank at an approved potable water filling facility or a known purified drinking water source.

The gravity tank fill tube is located behind a small, lockable door on the driver or passenger sidewall toward the back of the coach, depending on model.



- Insert hose into fill opening and turn water supply on. Tank is full when water flows from the tank vent tube beneath coach and out of the Gravity Fill door.

**Using Tank Water (Gravity Fill)**

- Turn Water Pump switch ON. While the switch is on, the water pump will automatically supply tank water as needed.

---

**WATER PUMP**

When your coach is not connected to a city water supply, water is supplied from the fresh water tank by a water system demand pump. A demand pump is designed to run only when you are using water. When you open a faucet, the waterline pressure drops and the pump begins to run, and it will continue to run as long as the

faucet is open. When you close the faucet, the line pressure backs up to the pump, and it shuts itself off.

The pump is self-priming and will run briefly to build up line pressure when the Water Pump switch is first turned on. See “Initial Waterline Priming” for instructions on using the water system for the first time.

**Further Information**

Refer to the Water Pump manufacturer’s operation, care, and maintenance information provided in your InfoCase.

**Water Pump Strainer**

The pump is equipped with a cleanable strainer to capture any possible tank-borne particles that could damage pump components.

*NOTE: We recommend that you check and clean the strainer after each tankful of water during the first few uses of the Water Pump system. Thereafter, remember to check it at least yearly, and be sure to empty water from it during winterization procedures.*



**Water Pump Strainer  
-Typical View**

**To Clean Pump Strainer**

- Ensure all Water Pump switches are OFF.
- Twist the inlet cap (bowl) “counter-clockwise” to unscrew from the strainer assembly.

- Remove the bowl and pull the strainer screen out of the bowl to tap out any particles and rinse clean.
- Insert the strainer screen back into the bowl, then screw the bowl back onto the strainer assembly.

*NOTE: You must also empty the strainer when winterizing your coach to avoid water freezing and cracking the filter bowl.*

### Water Pump Switch

The Water Pump switch is located near the monitor panel (some models may have an additional switch in the water service center or within the bathroom area for your convenience).

While the switch is “ON”, the pump will automatically supply water as it is needed.

We recommend that you turn the Water Pump switch off whenever you will be away from the vehicle or not using the water system. In time, a slow leak in a faucet could drain the water tank, fill the holding tank, and discharge the house batteries.

### Initial Waterline Priming

1. Ensure that all water drain valves are closed, including water heater valve.
2. Turn Water Pump switch to “OFF” position.
3. Fill water tank.
4. Open all faucets, hot and cold.
5. Turn ON the Water Pump switch.
6. Close each faucet as it begins to deliver a steady stream of water (close cold water first.) Leave hot water faucets on until they also deliver a steady stream of water. This will ensure that the water heater is filled with water.
7. Check to ensure the Water Pump stops soon after all faucets have been closed.
8. The Water Pump is now ready for automatic operation. The pump will start when a faucet is opened and stop when the faucet is closed.



Water Pump  
-Typical installation shown

- **Model 25R** - Located beneath removable floor panel in rear driver side compartment.
- **Model 25T** - Located behind removable access panel in rear driver side compartment.
- **Model 25Q** - Located beneath removable access panel under rear bed board.

---

---

## COLD WATER FILTER

### -If Equipped

To obtain filtered cold water for drinking or cooking, simply open the galley sink cold water faucet.

*NOTE: Only the cold water faucet is filtered.*

The cold waterline flows through an activated carbon filter that removes chlorine and odors for taste-free drinking water.



Cold Water Filter Assembly  
(Located below galley sink)  
*NOTE: Hot waterline is not filtered*

### Replacing the Cold Water Filter Cartridge

You should replace the filter cartridge every season and when water flow from the faucet is too slow for convenience. The cartridge must be replaced at least every 12 months.

- Place a container beneath the filter to catch any water remaining in the waterlines during filter removal.
- Twist the filter cartridge “counter-clockwise” about one-quarter turn, then pull it down and out of the filter socket.
- Insert a new water filter cartridge up into the filter socket as far as possible and twist it “clockwise” one-quarter turn until it stops.



- Insert new filter up into filter socket - press and twist 1/4 turn “clockwise”

- Before using the water for drinking, run a few gallons of water through the filter and discard water to avoid consuming carbon dust or particles that may have been present in the new filter cartridge.

### Diverter Plug

- Install the diverter plug into the filter socket for winterization or if water must be used while the filter is removed from the socket. The diverter plug is installed in the same manner as the water filter.

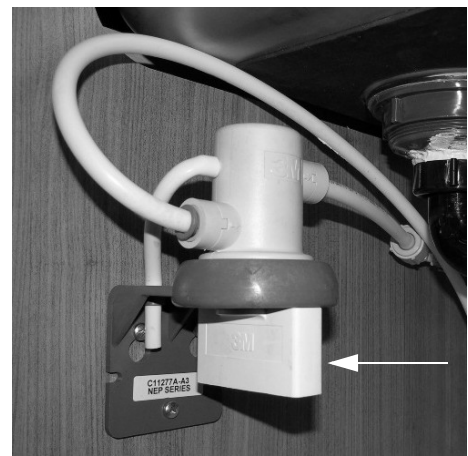

Diverter Plug (installed in filter socket)  
• Insert and twist 1/4 turn “clockwise”

- See “Winterization Procedure” at the end of this section for further information.
- When removing the coach from storage, always disinfect and flush the water system thoroughly before installing a new filter. See “Disinfecting Your Fresh Water System” elsewhere in this section for more information.

*NOTE: After the system has been thoroughly flushed, remove the diverter plug and store for future use.*

---

---

## DISINFECTING YOUR FRESH WATER SYSTEM

### (As required by NFPA®1192 Standard on Recreational Vehicles)

To ensure complete disinfection of the potable water system, it is recommended that the following procedure be followed on a new system, one that has not been used for a period of time, or one that could have become contaminated.

This procedure is also recommended before long periods of storage, such as over winter.

### Disinfecting with Gravity Fill

1. Prepare a chlorine solution using 1 gallon of water and 1/4 cup of household chlorine bleach (sodium hypochlorite solution). With tank empty, pour chlorine solution into the tank. Use 1 gallon solution for each 15 gallons of tank capacity. This procedure will result in a residual chlorine concentration of 50 ppm in the water system.

*If a 100 ppm concentration is desired as discussed in Step 4, use 1/2 cup of household bleach with 1 gallon of water to prepare the chlorine solution. One gallon of this solution should be used for each 15 gallons of tank capacity.*



## WARNING

Chlorine is poisonous. Do not misuse. Recap bottle and clean all utensils after use.

2. Complete filling of tank with fresh water.
3. Open each faucet in the coach and run the water until a distinct odor of chlorine can be detected in the water discharged. Do not forget the hot water faucets.
4. Let the system stand at least 4 hours when disinfecting with 50 ppm residual chlorine. *(If a shorter time period is desired, then a 100*

*ppm chlorine concentration should be allowed to stand in the system for at least 1 hour.)*

5. Drain the water tank and refill with fresh water.
6. Open each faucet again and run fresh water to flush chlorinated water from the lines. Run the water until there is no odor of chlorine detected in the water discharged. Do not forget the hot water faucets. *(You may need to leave a hot water faucet open for some time to flush the water heater with clean water. You may also want to turn the water heater off until this is done to avoid wasting energy trying to heat “unused” water).*
7. Water system is now disinfected.

### Continuous Tank Disinfection (Superchlorination)

Some RVers like to ensure continuous sanitation of their fresh water tank by “superchlorination”— maintaining an effective low level of chlorine in the tank at all times.

- Add 1 teaspoon of chlorine bleach (sodium hypochlorite) to your tank for each 10 gallons of tank capacity. When you fill the tank, this will result in a 6.7 ppm level of chlorine, which should kill harmful bacteria and slime-forming organisms.
- Chlorine may be removed from drinking water by the cold water filter at the galley faucet or by the separate filtered water faucet (if equipped).
- Superchlorination does not affect city water usage, only the fresh water tank.

---

---

## SHOWER HOSE VACUUM BREAKER

After using the shower, you may notice water dripping from the shower faucet assembly. The dripping results when vacuum in the shower hose (after closing the shower faucet) slowly releases and allows water remaining in the hose to drain down. This is a normal function of the shower valve assembly and is not a leak or defect.

If items are placed into the shower tub before shower valve vacuum release is complete, they may become wet.

---



---

## EXTERIOR SHOWER/WASH STATION

### –If Equipped

The Exterior Shower/Wash Station feature allows you to do things such as rinse off sand or salt after a swim, rinse off muddy boots, or bathe your pet outside the coach. Some models may have a Water Pump switch located near the shower faucet for convenience.



Exterior Shower/Wash Station  
-Typical View

---



---

## TOILET

The toilet in your motorhome is very similar to the household type, except that it is designed to use only a small amount of water per flush. It uses a high velocity jet of water, producing a swirl effect, to efficiently cleanse the bowl.

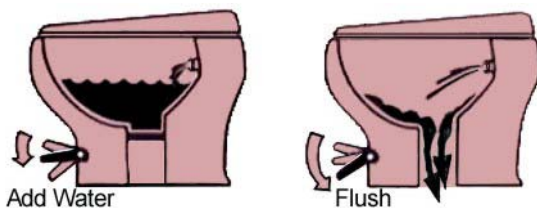

### Important “Don’ts”

- Don't use facial tissue or regular toilet tissue in the RV toilet. These will not disintegrate sufficiently and will often cling to the sides of the holding tank. Toilet tissue made specifically for use in RV toilets and holding tanks is available at most RV supply centers.
- Don't dispose of sanitary napkins or other non-dissolving items in the toilet.
- Don't put automotive antifreeze or caustic chemicals, such as laundry bleach or heavy detergents into the toilet or holding tank. These products may damage plastic or rubber parts in the system.

See winterizing instructions at the end of this section to prepare the toilet for storage in freezing conditions.

### Further Information

See the toilet manufacturer's operation information in your InfoCase for complete operating, care, and maintenance information.

---



---

## DRAINAGE SYSTEM (P-TRAPS)

Ensure there is an adequate amount of water in the drainage system p-traps to avoid sewer odor from entering your coach.

If you should experience a sewer odor, pour approximately 1 cup of water down each sink and shower drain in the coach.

---



---

## WASTE WATER SYSTEM - MODEL 25R

### (Holding Tanks)

The drainage system is self-contained and uses two separate holding tanks to contain the waste water until it can be dumped at an appropriate waste water disposal site. This means you can use the toilet, sinks, and shower even in areas where utility hookups are not available.

The black water holding tank contains the sewage from the toilet and may include bathroom lavatory on some models. The gray water holding

tank contains the waste water from the galley sink and shower, and may include bathroom lavatory.

See “Specifications” in *Section 1–Introduction* for tank capacities for your model.

### Dumping Holding Tanks

1. Remove sewage drain hose from cylindrical compartment near water service center or LP fill, depending on model.
2. Remove dust cap from sewage drain outlet and connect sewage drain hose. Be sure it is firmly attached.



Sewage Drain Outlet  
(Located underneath coach  
behind driver side rear wheel)  
-Typical View

3. Place the outlet end of sewage drain hose into disposal opening.
4. Open the Black Waste Tank Drain valve with a quick pull and make sure there are no sags in the hose. Move the hose gently about to dislodge any waste and ensure complete drainage. Close Black Waste Tank Drain valve as soon as tank is empty.

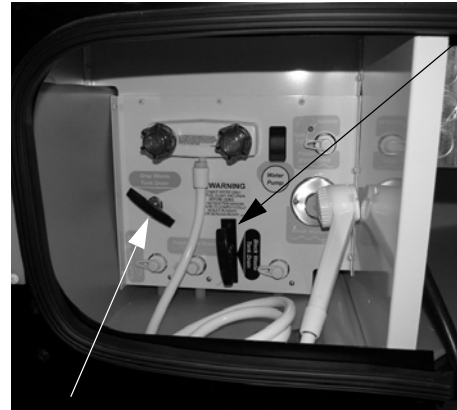

1st - Pull  
Black  
Waste  
Tank Drain  
valve to  
drain Black  
Water  
(sewage)  
tank – then  
close.

2nd - Pull Gray  
Waste Tank Drain  
valve to drain  
Gray Water (sink/  
shower) tank –  
then close.

Holding Tank Drain Valves  
(Located in water service center)  
-Typical View

**NOTE: DO NOT OPEN BOTH VALVES AT ONCE.** Do not open the Gray Waste Tank Drain valve until the black tank is drained and dump valve closed to avoid sewage back-up into gray tank. Gray water also rinses any black water solids from the sewage drain hose. Black and Gray tank valve positions may be reversed depending on floorplan and tank location.

5. Open the Gray Waste Tank Drain valve. Be sure there are no sags in the hose to ensure complete drainage. Close Gray Waste Tank Drain valve as soon as tank is empty.
6. Add an odor control chemical to the sewage holding tank through the toilet. These chemicals are available at most RV stores.
7. Rinse sewage drain hose thoroughly with water and stow.

**NOTE:** We recommend that you dump all holding tanks before traveling to avoid carrying unnecessary weight.

## Using On-Site Sewer Hook-Ups

The sewage drain hose may remain attached to the sewage drain outlet while the motorhome is parked and connected to an on-site sewage hook-up.

When using a sewer hook-up, keep the dump valves closed until a tank becomes full or when preparing to leave the site. This keeps the solids in suspension, allowing them to be carried out with the liquids when the dump valve is opened. If the valve is left open, the liquids will drain off, leaving solids in the tank. Should this accidentally happen, disconnect the hose, fill the tank about half full with water, and drive a few miles to dislodge the solids. A few starts and stops will aid in the process. Then reconnect the hose and drain in the normal manner.

*NOTE: Always keep sewage drain outlet capped while sewage connection is not in use.*

## Holding Tank Level Indicators

See “Systems Monitor Panel” in *Section 4 - Appliances* for further information on the monitor panel and checking tank levels.

See “Specifications” in *Section 1 - Introduction* for tank capacities for your model.

## WASTE WATER SYSTEM (WASTE PUMP) - MODELS 25T & 25Q

### (Holding Tanks)

The drainage system is self-contained and uses two separate holding tanks to contain the waste water until it can be dumped at an appropriate waste water disposal site. This means you can use the toilet, sinks, and shower even in areas where utility hookups are not available.

The black water holding tank contains the sewage from the toilet and may include bathroom lavatory on some models. The gray water holding tank contains the waste water from the galley sink and shower, and may include bathroom lavatory.

See “Specifications” in *Section 1 - Introduction* for tank capacities for your model.

## Waste Pump

The 12-volt Waste Pump disposes gray holding tank waste through a small diameter sewer hose, which is then drained through the main sewage drain outlet.



Waste Pump  
(Located behind removable  
panel in water service center)  
-Typical View

*NOTE: If Waste Pump stalls, check breaker in the load center. If problem persists, remove end cap and manually turn pump shaft (located on the end of the Waste Pump) with a screwdriver.*

## Waste Pump Access

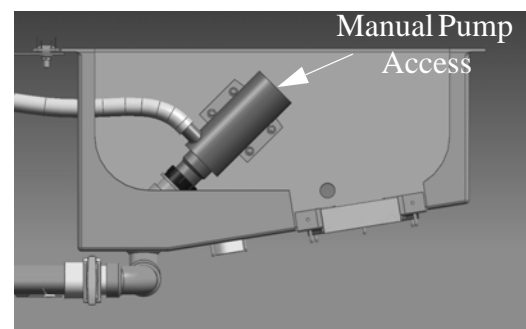

Waste Pump Access  
(Located behind removable  
panel in water service center)

## Further Information

For further information and operating cautions, see the Waste Pump manufacturer’s user guide provided in your InfoCase.

**Dumping Holding Tanks**

1. Remove sewage drain hose from passenger rear compartment or cylindrical compartment near water service center, depending on model.
2. Remove dust cap from sewage drain outlet and connect sewage drain hose. Be sure it is firmly attached.

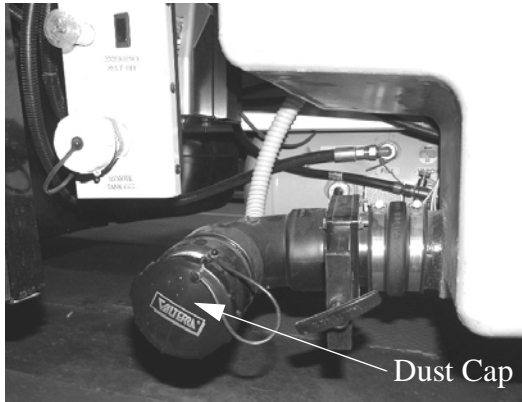

**Sewage Drain Outlet**  
(Located in driver side compartment)  
-Typical View

3. Place the outlet end of sewage drain hose into disposal opening.
4. Open the Black Waste Tank Drain valve with a quick pull and make sure there are no sags in the hose. Move the hose gently about to dislodge any waste and ensure complete drainage. Close Black Waste Tank Drain valve as soon as tank is empty.

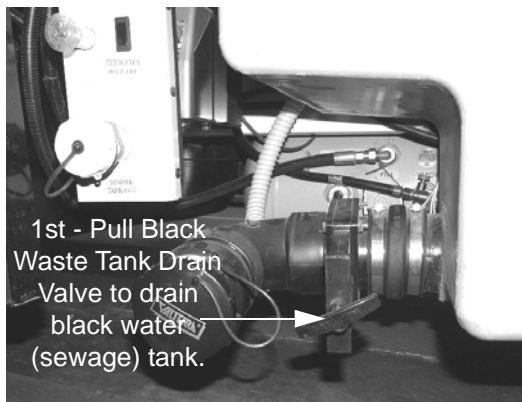

**Black Waste Tank Drain Valve**  
(Located in driver side compartment)  
-Typical View

*NOTE: DO NOT OPEN BOTH VALVES AT ONCE. Do not open the Gray Waste Tank Drain valve until the black tank is drained and dump valve closed to avoid sewage back-up into gray tank. Gray water also rinses any black water solids from the sewage drain hose.*

5. Open the Gray Waste Tank Drain valve (located beneath driver side rear compartment). Press and Hold the Waste Pump switch (located in the water service center). Release the Waste Pump switch and close the Gray Waste Tank Drain valve as soon as the tank is empty.

*NOTE: Sound of Waste Pump will change significantly when tank is empty.*



**Gray Waste Tank Drain Valve**  
(Located underneath driver side rear compartment)  
-Typical View

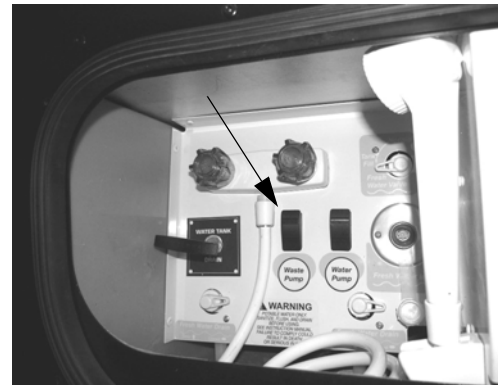

**Waste Pump Switch**  
(Located in water service center)  
-Typical View



6. Add an odor control chemical to the sewage holding tank through the toilet. These chemicals are available at most RV stores.
7. Rinse sewage drain hose thoroughly with water and stow.

*NOTE: We recommend that you dump all holding tanks before traveling to avoid carrying unnecessary weight.*

### Using On-Site Sewer Hook-Ups

The sewer hose may remain attached to the sewage drain outlet while the motorhome is parked and connected to an on-site sewage hook-up.

When using a sewer hook-up, keep the dump valves closed until a tank becomes full or when preparing to leave the site. This keeps the solids in suspension, allowing them to be carried out with the liquids when the dump valve is opened. If the valve is left open, the liquids will drain off, leaving solids in the tank. Should this accidentally happen, disconnect the hose, fill the tank about half full with water, and drive a few miles to dislodge the solids. A few starts and stops will aid in the process. Then reconnect the sewer hose and drain in the normal manner.

*NOTE: Always keep sewage drain outlet capped while sewage connection is not in use.*

### Holding Tank Level Indicators

See “Systems Monitor Panel” in *Section 4 - Appliances* for further information on the monitor panel and checking tank levels.

See “Specifications” in *Section 1 - Introduction* for tank capacities for your model.

---

## HOLDING TANK HEATER

### –If Equipped

Your coach may be equipped with black water and gray water holding tank heaters to allow use of waste utilities in freezing temperatures.

### Holding Tank Heater Switch Location:

- **Models 25T and 25Q** - Located on back of bath wall near thermostat.

- **Model 25R** - Located above thermostat near rear TV.

The illuminated switch will glow when the power is on.



Holding Tank Heater Switch  
-Typical installation shown

DO NOT operate the holding tank heater unless you are providing a supplemental 12-volt power source to recharge the house/coach batteries. This means either the shoreline cord must be plugged into a 120-volt source, the generator must be operating, or the chassis engine must be running (such as when driving down the road). This will prevent excessive discharge of the house/coach battery.

*NOTE: The holding tank heater pads are electrical resistance-type heating elements. This type of heating element typically uses a large amount of current while operating. If the tank heaters are used without a recharging source, they will drain the house/coach batteries in a relatively short period. Typically, the batteries would not support overnight heating without a supplemental charging source.*

---

## WATERLINE AND TANK DRAIN VALVES

The Waterline and Water Tank Drain valves are used to drain water from the water tank and the water supply lines when preparing the motorhome for storage or when sanitizing the water system.

Refer to the “Water System Drain Valve Locations” chart at the end of this section for locations on your model.

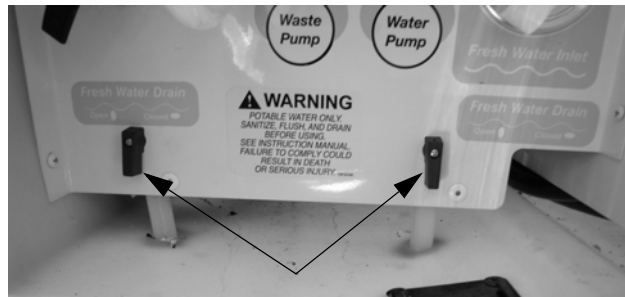
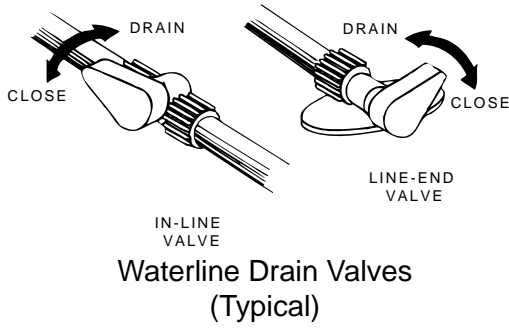

**Waterline Drain Valves  
-Typical installation shown**



**Water Tank Drain Valve  
-Typical installation shown**

Refer to the “Water System Drain Valve Locations” chart at the end of this section for locations on your model.

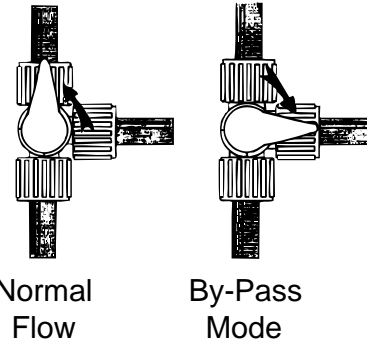

**⚠ CAUTION**

Leave bypass valve handle in **NORMAL FLOW** position if draining water and blowing out waterlines. Place in **BYPASS** position **ONLY** when using antifreeze solution in waterlines.

## WINTERIZING PROCEDURES

You can winterize the water and plumbing system of your coach using one of the following two methods – 1) Blow out waterlines using compressed air or – 2) Fill waterlines with RV water system antifreeze.

### **Method 1 – Blow Out Procedure (Drain and purge waterlines using compressed air)**

1. **Level the Motorhome.** If the coach is not level, there may be “low points” in waterlines that can trap water in the lines and prevent it from draining properly.
2. **Drain Fresh Water Tank and Waterlines.** Open all waterline drain valves and drain fresh water tank. (See “Water System Drain Valve Locations” chart at end of this section for locations of drain valves on your model).
3. **Drain Exterior Shower/Wash Station.** Open exterior shower knobs and lay shower head on ground as shown to drain any water

## WATER HEATER BYPASS AND ANTIFREEZE SIPHON VALVES

Your coach is equipped with a Water Heater Bypass valve and an Antifreeze Siphon (Winterization) valve for winterizing waterlines using RV antifreeze.

Turn the handle as shown to either bypass or flow mode.

left in the shower line. Also place the tip of your finger into the city water inlet and gently press the backflow valve “button” in the center of the inlet to drain any water trapped in the inlet line.



Using exterior shower to drain waterline  
(Typical view - appearance on  
your coach may differ)

4. **Remove the Cold Water Filter Cartridge (if equipped).** Remove the filter cartridge from the filter assembly below the galley sink. *(If your coach is not equipped with a cold water filter, continue to next numbered step.)*
  - Place a container beneath the filter to catch any water that may drain from the waterline during filter removal.
  - Twist the filter cartridge “counter-clockwise” about one-quarter turn, then pull it down and out of the filter socket. Discard used filter.



- Install the diverter plug into the filter socket. Insert plug up into the filter socket as far as possible and twist “clockwise” one-quarter turn until it stops.



5. **Open Faucets.** Turn Water Pump switch ON and open all sink faucets and shower head knobs. Leave open after water stops flowing.
6. **Drain Toilet.** Press the toilet flush pedal and hold until water stops flowing in the toilet. Then turn Water Pump switch OFF.
7. **Drain Water Heater.** Turn OFF the Water Heater Power switch before draining the water heater tank to avoid damage to the heating element. Drain the water heater by removing the plug from the base of the water heater tank, accessible from the outside of the coach (requires socket and ratchet).



Water Heater Drain Plug  
(Remove with socket)

- Also, open the Pressure-Temperature Relief valve at the top right portion of the tank to prevent air locking in the tank while draining.

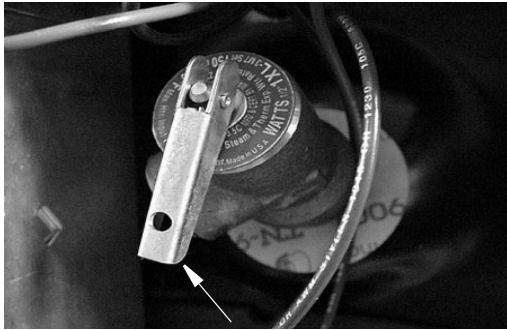

Pressure-Temperature Relief Valve  
(Lift handle only when water heater is cold)

8. **Connect Air Pressure.** After water has stopped draining at all faucets and drain valves, leave faucets open and connect a “blow-out” plug to the city water connection on the coach. Then use a compressed air hose regulated to 30 psi or less to force air through the system. A “blow-out” plug can be purchased at any Winnebago® or Itasca® dealer.

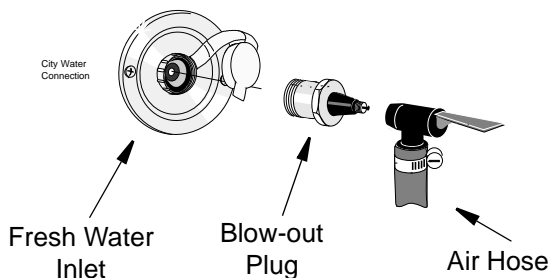

## NOTICE

Limit air pressure to 30 psi to avoid damage to equipment.

- NOTE: DO NOT burst air into the system. This can damage the water pump. It is better to let air in slowly.*
9. **Let air flow for five minutes** until water is completely drained out of faucets and drain valves. Then close faucets one at a time.
10. **Drain Toilet.** Operate and hold toilet flush lever until water is completely drained from toilet.

11. **Turn air pressure off.** Disconnect water purge adapters. Recap the city water inlet to avoid contamination by dirt or insects.

### After Disconnecting Air Pressure

12. Close all waterline drain valves, tank drain valves, and all faucets to avoid contamination by dirt, insects, or rodents.
13. Reinstall the water heater drain plug and close the Pressure-Temperature Relief valve.
14. Pour about one cup of RV antifreeze down each drain for the galley sink, lavatory sink, and shower/tub. This fills the drain trap pipes to prevent holding tank odors from entering the coach during storage.

*NOTE: It is not necessary to add antifreeze to the toilet since the flush valve will be closed.*

*Do not add automotive antifreeze or caustic chemicals such as bleach or laundry detergents into the toilet bowl or holding tanks. Although these products may have a deodorizing effect, they may damage plastic and rubber parts in the system.*

15. Empty the water pump strainer filter bowl to avoid water freezing and cracking the filter bowl. See “Water Pump” previously in this section.

### Dump and Clean Holding Tanks

16. Completely drain the waste water holding tanks at an approved waste disposal site. Drain the sewage tank first so the following waste water can rinse any waste solids from the dump outlet and sewage drain hose.
17. Close dump valves and refit the dust cap onto the drain outlet. This will inhibit rust formation on valve shafts and prevent entry and contamination by airborne debris, insects, and rodents.

*Your drainage and fresh water systems are now winterized.*

*See instructions for removal from storage in Section 11 - Maintenance and Storage.*

## Method 2 – Antifreeze Fill Procedure (Fill plumbing lines with RV water system antifreeze)

*NOTE: As an alternative to totally draining the waterlines, you may winterize tanks and lines by filling them with non-toxic RV water system antifreeze through the plumbing system.*

*This product is available from your dealer and from most RV supply stores and national retail outlets.*

*Follow directions on the container to determine the correct amount to use for your coach.*

Your coach is equipped with a manually operated waterline winterization system for your convenience in winterizing fresh waterlines.

The system features a Winterization (diverter) valve with antifreeze siphon tube to draw non-toxic RV water system antifreeze into the waterlines. There is also a Water Heater Bypass valve to avoid filling the water heater with antifreeze. This feature is located near the water pump. See the “Water System Drain Valve Locations” chart at the end of this section for locations on your model.

Leave the Water Heater Bypass valve handle in NORMAL FLOW position if draining water and blowing out waterlines. Place in BYPASS position ONLY when using antifreeze solution in waterlines.

### WARNING

NEVER use automotive antifreeze/coolant in your RV water system. Automotive coolant/antifreeze contains ethylene glycol which, if ingested, can cause blindness and can be fatal.

## Remove Water Filter

1. Remove and discard the filter cartridge from the cold water filter assembly below the galley sink. *(If your coach is not equipped with a cold water filter assembly, continue to next numbered step).*
  - Place a container beneath the filter to catch any water remaining in the waterlines during filter removal.
  - Twist the filter cartridge “counter-clockwise” about one-quarter turn, then pull it down and out of the filter socket.



- Install the diverter plug into the filter socket. Insert plug up into the filter socket as far as possible and twist “clockwise” one-quarter turn until it stops.



## Set Up Winterization Valves

2. Turn the Water Heater Bypass valve to BYPASS position to avoid filling water heater with antifreeze.

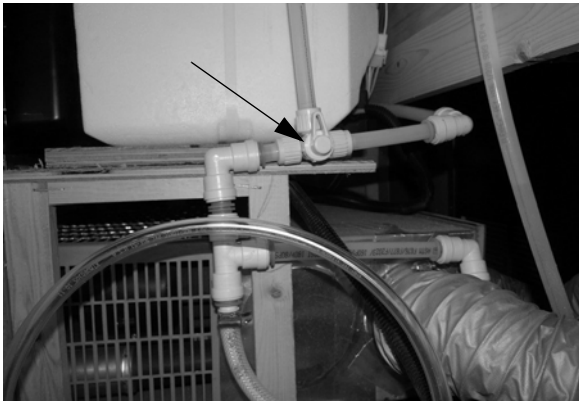

**Water Heater Bypass Valve**

- **Model 25T** - Located behind removable access panel in driver side rear compartment
  - **Model 25R** - Located under wardrobe cabinet behind flip-down door
  - **Model 25Q** - Behind removable access panel under wardrobe cabinet
- Typical View

3. Remove and save the protective cap from the end of the antifreeze siphon tube. Insert the end of the siphon tube into a pail or other container with 2 to 3 gallons of non-toxic RV antifreeze solution.  
(See “Water System Drain Valve Locations” chart at the end of this section for location on your model).

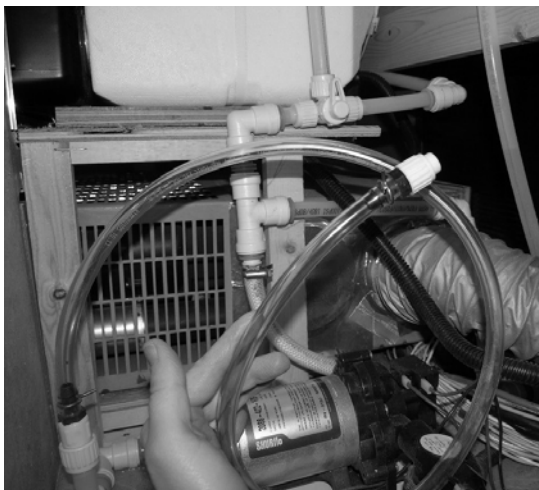

**Antifreeze Siphon Tube**  
-Typical View

- See the “Water System Drain Valve Locations” chart at the end of this section for specific location on your model.

4. Turn the Winterization valve handle so it points toward the antifreeze siphon tube. This will allow the siphon tube to draw non-toxic RV antifreeze into the waterlines.  
(See “Water System Drain Valve Locations” chart at the end of this section for location on your model).



**Winterization Valve**  
-Typical View

- See the “Water System Drain Valve Locations” chart at the end of this section for specific location on your model.

*NOTE: Ensure that all drain valves are CLOSED before pumping RV antifreeze into the water system.  
Refer to the “Water System Drain Valve Locations” chart at the end of this section for valve locations on your model.*

**Fill Lines**

5. Turn the Water Pump switch ON.
6. Open each hot and cold water faucet handle/knob in the coach – one at a time each in turn until antifreeze solution just begins to flow from the faucet, then close.  
Do not forget exterior shower/wash station knobs (if equipped).
7. Press the toilet flush pedal and hold until antifreeze begins flowing into the toilet.  
Leave small amount of antifreeze that remains in the bowl.

**When Done Adding RV Antifreeze**

8. Turn the Water Pump switch OFF.
9. Turn the Winterization valve so it points toward the waterline connected to the water pump.  
This will stop the flow from the antifreeze siphon tube and revert the tank line flow to the water pump.
10. Replace the protective cap onto the end of the antifreeze siphon tube to keep out insects or debris when not in use.

**Drain Water Heater**

11. Turn OFF the Water Heater Power switch before draining the water heater tank to avoid damage to the heating element.
12. Drain the water heater by removing the plug from the base of the water heater tank, accessible from the outside of the coach (requires socket and ratchet).



Water Heater Drain Plug  
(Remove with socket)

13. Open the Pressure-Temperature Relief valve at the top right portion of the tank to prevent air locking in the tank while draining.



Pressure-Temperature Relief Valve  
(Lift handle only when water heater is cold)

14. Reinstall the water heater drain plug and close the Pressure-Temperature Relief valve when drained.

**Fill Drainage System P-Traps**

15. Pour approximately one cup of RV antifreeze down each drain for the galley sink, lavatory sink, and shower/tub. This fills the drain trap pipes to prevent holding tank odors from entering the coach during storage.

**Dump and Clean Holding Tanks**

16. Completely drain the waste water holding tanks at an approved waste disposal site. Drain the sewage tank first so the following waste water can rinse any waste solids from the dump outlet and sewage drain hose.
17. Close dump valves and refit the dust cap onto the drain outlet.  
This will inhibit rust formation on valve shafts and prevent entry and contamination by airborne debris, insects, and rodents.

*Your drainage and fresh water systems are now winterized.*

*See instructions for removal from storage in Section 11 - Maintenance and Storage.*

**To Winterize the Waste Pump  
-If Equipped**

- Ensure that black and gray holding tanks are completely empty.
- Remove Waste Pump Drain (located underneath rear driver side of coach) to drain any gray water trapped in the drain line. Remove with socket/wrench.

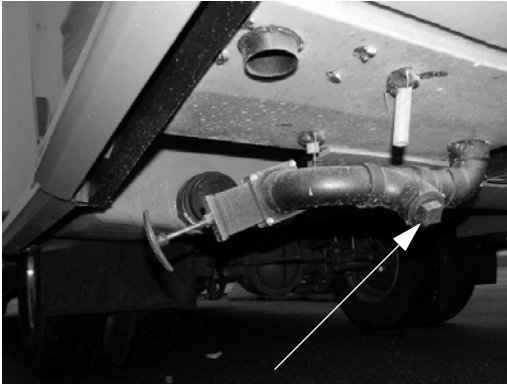

Waste Pump Drain  
(Located underneath rear driver side of coach)  
\* Models 25T and 25Q only

- Pour 2 gallons of RV antifreeze down the shower OR galley sink drain.
- Press and hold the Waste Pump switch for approximately 5-10 seconds to get antifreeze into the pump.



WATER SYSTEM DRAIN VALVE LOCATIONS		
Model	System	Drain Valve Locations
25T	<b>Waterlines</b>	<ul style="list-style-type: none"> <li>Two (2) drain valves in the water service center and two (2) drain valves located through an access hole beneath the bed. <i>Also, place the tip of your finger inside the city water connection and gently press the backflow valve (small “button” in center of connector) to drain any water left in the city waterline.</i></li> </ul>
	<b>Water Tank</b>	<ul style="list-style-type: none"> <li>One (1) valve located in the water service center.</li> </ul>
	<b>Water Heater</b>	<ul style="list-style-type: none"> <li>Drain plug on outside of coach behind service door. Use socket to remove drain plug.</li> </ul>
	<b>Water Heater Bypass Valve</b>	<ul style="list-style-type: none"> <li>One (1) valve in rear driver side compartment (located beneath bed). Remove panel to access.</li> </ul>
	<b>Winterization (Antifreeze) Valve</b>	<ul style="list-style-type: none"> <li>One (1) valve and antifreeze siphon tube in rear driver side compartment (located beneath bed). Remove panel to access.</li> </ul>

**SECTION 7 –  
PLUMBING**



25R	<b>Waterlines</b>	<ul style="list-style-type: none"> <li>Two (2) drain valves in the water service center and also beneath the wardrobe (behind flip-down door). <i>Also, place the tip of your finger inside the city water connection and gently press the backflow valve (small “button” in center of connector) to drain any water left in the city waterline.</i></li> </ul>
	<b>Water Tank</b>	<ul style="list-style-type: none"> <li>One (1) valve located in the water service center.</li> </ul>
	<b>Water Heater</b>	<ul style="list-style-type: none"> <li>Drain plug on outside of coach behind service door. Use socket to remove drain plug.</li> </ul>
	<b>Water Heater Bypass Valve</b>	<ul style="list-style-type: none"> <li>One (1) valve under wardrobe cabinet (behind flip-down door).</li> </ul>
	<b>Winterization (Antifreeze) Valve</b>	<ul style="list-style-type: none"> <li>One (1) valve and antifreeze siphon tube in rear driver side compartment.</li> </ul>
25Q	<b>Waterlines</b>	<ul style="list-style-type: none"> <li>Two (2) drain valves in the water service center. <i>Also, place the tip of your finger inside the city water connection and gently press the backflow valve (small “button” in center of connector) to drain any water left in the city waterline.</i></li> </ul>
	<b>Water Tank</b>	<ul style="list-style-type: none"> <li>One (1) valve located in the water service center.</li> </ul>
	<b>Water Heater</b>	<ul style="list-style-type: none"> <li>Drain plug on outside of coach behind service door. Use socket to remove drain plug.</li> </ul>
	<b>Water Heater Bypass Valve</b>	<ul style="list-style-type: none"> <li>One (1) valve beneath wardrobe. Remove panel to access.</li> </ul>
	<b>Winterization (Antifreeze) Valve</b>	<ul style="list-style-type: none"> <li>One (1) valve and antifreeze siphon tube in the water service center.</li> </ul>

## SECTION 8 – ENTERTAINMENT

### TV – 12V LED

#### -If Equipped

The LED flat panel TV is powered by 12-volt DC current.

The 12-volt current is supplied from the house batteries, or from the power converter when connected to shoreline power or running the generator.

*NOTE: The 12-Volt TV Master Power switch must be ON to operate the TV.*



12-Volt TV Master Power Switch  
(Located in overhead cabinet  
or on a wall near the TV)  
-Typical installation shown

*NOTE: When the TV is not in use, the 12-Volt TV Master Power switch should be turned OFF to eliminate drain on the 12-volt house battery.*

#### Further Information

See the television manufacturer's user guide provided in your InfoCase for complete operating instructions.

### TV – PULL OUT

#### -If Equipped

Your coach may be equipped with a galley TV extend/retract mechanism, which allows you to watch TV when the slideout room is retracted.

#### To Extend TV

- Open the wooden cabinet cover located on the inboard side of TV.



- Extend TV.



#### Further Information

See the television manufacturer's information in your InfoCase for operating instructions.

### AUDIO-VIDEO SYSTEM BASIC OPERATION

*NOTE: For your convenience, we have also included a handy, tear-out version of this "A/V System Basic Operation" guide in Section 8 of your Operator's Manual*

*Supplement.  
See your InfoCase for specific operating  
guides for audio and video components.*

---

---

## DVD PLAYER WITH DELUXE SOUND

### –If Equipped

The DVD player is a selectable function of the multi-featured audio system. The player unit contains DVD/CD/MP3/AM-FM stereo radio. It also accepts portable audio player inputs and it also functions as an alarm clock.

The DVD player is connected directly to the TV (on Model 25R) or connected to an A/V distribution system (on Models 25T and 25Q) and can output sound to either the stereo speakers in the TV or to the Deluxe Sound speakers in the lounge area of the coach.

Refer to the manufacturer’s information provided in your InfoCase for complete feature descriptions and operating instructions.

### Interior Speaker System



Interior Speaker Switch  
“SPEAKER A”

- To connect or disconnect the interior speaker system, press SPEAKER A.

### Set TV Video Input

- Turn TV and DVD player ON.
- Press the MODE button on the TV or the SOURCE button on the remote to select INPUT 1.

- The TV screen will display the DVD player logo when the correct input is selected.



### Play DVD

- Insert a DVD “face up” into slot on lower face of the player.
- The DVD will begin to “load” automatically. The TV screen will typically display “READING” or “LOADING.”
- The DVD may load directly to the main title/menu screen or it may begin to play previews. You may be able to skip previews if desired by pressing the NEXT button on the DVD remote until you see the main menu screen.
- When the main menu screen appears, press the ENTER button on the remote or PLAY/PAUSE button on DVD player to begin playing the main feature. Use the arrow buttons on the DVD remote to select another feature to play.
- Volume is adjusted with the DVD remote.



### TV Sound through Deluxe Sound Speakers

When watching TV programs alone, the TV normally plays sound through its own built-in stereo speakers. If you wish to connect TV stereo sound output to the Deluxe Sound speakers for a richer sound quality, follow these steps:

1. Turn the TV ON.
2. Make sure the Interior Speaker System is ON.
3. Press the AUX input selection button (located just below the display on the face of the DVD player.) This will route the TV stereo sound output through the DVD player and out to the Deluxe Sound speakers.
4. Select TV channels and adjust volume using the TV remote.

**Further Information**

See the manufacturer’s quick reference guide provided in your InfoCase for complete feature descriptions and operating instructions.

**TV ANTENNA - DIGITAL  
(Jack® Digital HDTV Over-the-Air Antenna)**

Your coach is featured with a digital antenna, which provides crystal clear digital HD reception of over-the-air channels in addition to superior broad reception range.

The digital antenna is equipped with a built-in amplifier for maximum VHF and UHF programming.

 <b>WARNING</b>
<p>Never allow the antenna to touch electrical power lines or any other electrical wires.</p>

**Operating the Digital Antenna**

1. Turn the Digital Antenna Power Switch ON.

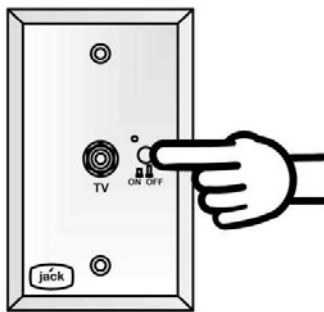

Digital Antenna Power Switch  
(Located in an overhead cabinet or mounted on a wall near the TV)

2. Turn ON the Signal Meter Power switch (located on the side of the Signal Meter).

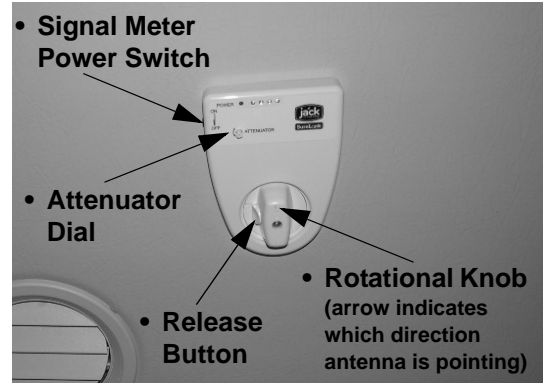

Digital Antenna Signal Meter  
(Located on ceiling)

3. Rotate the Attenuator Dial fully **CLOCKWISE**.
4. Press Release Button on the Rotational Knob and rotate antenna (until maximum number of LED lights illuminate on the Signal Meter).

*NOTE: LED lights will illuminate from left to right. All LED lights may not illuminate, depending on signal strength.*

5. Rotate Attenuator Dial **COUNTER-CLOCKWISE** until the last illuminated LED light flickers.
6. Rotate antenna to illuminate the last flickering LED light.
7. Repeat Steps 5 and 6 to pinpoint signal reception.

*NOTE: Refer to television manufacturer’s instructions to scan for available channels.*

**Further Information**

See the antenna manufacturer’s user guide provided in your InfoCase for complete operating and maintenance information.

**TV SIGNAL AMPLIFIER**

The TV Signal Amplifier is built into the antenna and can be turned on or off with a power switch located on a switchplate near the entertainment center cabinet.

An indicator light will illuminate when the switch is on and the signal amplifier is active.



TV Signal Amplifier Power Switch  
(Located near entertainment center cabinet)  
-Typical View

We recommend that you read the satellite dish manual thoroughly to understand the system completely before attempting any setups or adjustments.

- The coach must be level before attempting to adjust the antenna dish.
- There must be a clear “line of sight” to the satellite. Mountains, buildings, trees, telephone poles and other obstructions can all block the satellite signal from reaching the dish.

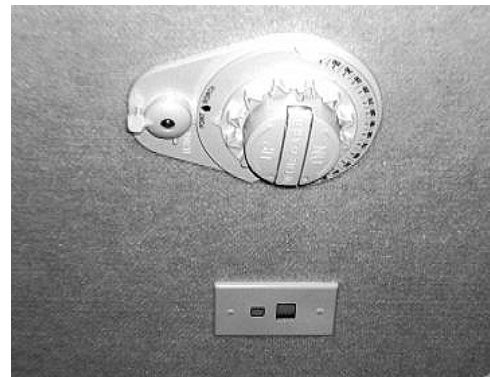

Digital Satellite Dish Control  
(Located on ceiling)  
-Typical View

---

---

## CABLE TV AND SATELLITE CONNECTIONS

Cable television and satellite input connections are located in the shoreline compartment or in the utility compartment, depending on model.



Exterior Cable TV and Satellite Connections  
(Located in shoreline or utility compartment, depending on model)



### Further Information

See the Digital Satellite System user guide provided in your InfoCase for complete operating instructions.

---

---

## TV DIGITAL SATELLITE SYSTEM – MANUAL

### -If Equipped

The Digital Satellite Television System allows you to receive TV programs directly from satellite to your coach.

---

---

## TV DIGITAL SATELLITE SYSTEM WIRING

Your coach is pre-wired for installation of a digital satellite TV system. Coaxial cable and high definition component cable connections are available to hook up your satellite receiver and are located near the entertainment center cabinet.

A second connection may be included inside a cabinet in the bedroom for the rear TV (if equipped).

See your authorized Winnebago Industries® dealer for proper installation and sealing of roof mounted components.



Interior Satellite Dish and HDMI Connections  
(Located near entertainment center cabinet)  
-Typical installation shown





## SECTION 9 – FURNITURE AND SOFTGOODS

### SLEEPING FACILITIES

 <b>WARNING</b>
<p>Sleeping facilities are not intended for use while vehicle is in motion. For safety, passengers must use safety belted seating positions while vehicle is in motion.</p>

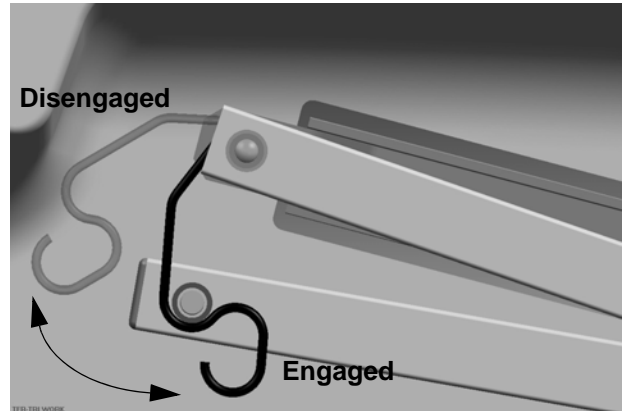

Bunk Storage Latches  
(Located on each side of bunk)

### FRONT BUNK

#### -If Equipped

The Front Bunk is stowed near the cab ceiling as shown in the following photo.



*NOTE: This low bunk design may be accessed without the use of a ladder. If needed, a multi-purpose step stool may be used.*

#### To lower bunk for use

1. Move both the driver and passenger cab seats forward and recline completely to allow clearance for the bunk to be lowered. See “Seats - Driver/Co-Pilot” in *Section 3 - Driving Your Motorhome* for further information.
2. Lift UP on bunk handle while disengaging the Bunk Storage Latches (one located on each side of the bunk) and lower.

- Maximum Capacity: 300 lbs.
- To avoid injury to young children, do not leave them unattended on the bunk.

#### Stowing the bunk

Reverse previous steps to store bunk, ensuring Bunk Storage Latches are engaged.



**WARNING**

Engage bunk storage latches. Failure to do so can allow bunk to drop, which may result in injury or loss of vehicle control. See Operator's Manual.

---

---

**FLEX BED  
(Model 25T)**

Your coach is featured with a Flex Bed system, which sleeps as two twin beds - or you can choose to easily convert them into a queen size bed.

1. Pull center bed board out into the fully extended position, assuring that the edge of the bed board is pulled over the two end bumpers.



2. Lay fitted cushion over the extended bed board.



3. Reverse steps to store bed back into twin bed position.



---

---

**BED EXTENSION  
(Model 25R)**

The bed in your coach has an extension that slides out and converts easily into a larger sleeping area.

**Extending Bed**

1. Grasp the pull strap (located on the front edge of the bed board) and pull straight out.



2. Arrange the cushions to fill in the open spaces.



To convert bed back into stored position, remove cushions and push bed board against wall.

*NOTE: Ensure the bed is in the stored position (flush against driver side wall with cushions removed) before retracting the slideout room to prevent possible property damage.*

---

**COMFORT SOFA SLEEPER**  
**–If Equipped**  
(Typical view – your coach may vary according to floorplan)

Your coach may be equipped with a Comfort Sofa Sleeper, which is featured with an air bed that can be adjusted to the firmness of your choice.

**Sofa to Bed**

1. Remove seat back cushions and set aside.



2. Remove rectangular seat back cushion and set aside.



3. Using the pull strap (attached to the back side of the sofa), pull the sofa back out and extend all the way down to the floor.



**SECTION 9 –  
FURNITURE AND SOFTGOODS**



4. Unfold the air mattress so it is covering the sofa bed.



*NOTE: The air mattress is plugged into an AC power outlet behind the sofa. It may be necessary to press the “Reset” button on the galley GFCI outlet before operating.*

5. Turn the Comfort Adjust dial (located on the Air Bed Control) to desired firmness - *Plush*, *Medium*, or *Firm*.



**Air Bed Control**  
(Located at head of mattress)

6. Turn the Inflate/Deflate switch “clockwise” to the INFLATE position.

*NOTE: Pump will automatically turn off once selected firmness level is reached and the Inflate/Deflate switch will automatically return to the OFF position.*



**Silent Night Comfort Adjust**

If your air bed pressure drops below the predetermined pressure level, the Silent Night Comfort Adjust Pump will automatically turn on to re-inflate. The pump operates silently so that it will not disturb your sleep.

Turn the Comfort Adjust dial to the OFF position to disable the Silent Night Comfort Adjust feature.

**Bed to Sofa**

1. Turn the Comfort Adjust dial (located on the Air Bed Control) to the OFF position (to keep the pump from automatically turning on during storage).



**Air Bed Control**  
(Located at head of mattress)

2. Turn the Inflate/Deflate switch “counter-clockwise” to the DEFLATE position for complete air removal.

*NOTE: Pump will automatically turn off and the Inflate/Deflate switch will automatically return to the OFF position upon complete deflation.*



3. Fold mattress edges back 6 inches and foot end of mattress back 20 inches.

**NOTICE**

To avoid mattress damage, fold edges back 6 inches and foot end back 20 inches before returning to sofa position.



4. Grasp the pull strap and proceed to bring sofa all the way up.
5. Reinstall rectangular seat back cushion.

6. Reinstall two front seat back cushions.

### Further Information

See the air bed manufacturer’s user guide provided in your InfoCase for complete operating instructions, safety precautions, and repair information.

---



---

### DINETTE/BED CONVERSION

#### –If Equipped

(Typical view – your coach may differ)



#### Dinette to Bed

1. Release the catch on the table leg brace and fold the leg up against the bottom of the table.



2. Remove the table from the wall support bracket by lifting the end of the table. Then lower the table to rest on the cleats attached to each dinette bench.



3. Arrange dinette cushions to cover bed area.



### **Bed to Dinette**

1. Reattach the table onto the wall support and lower the table leg.

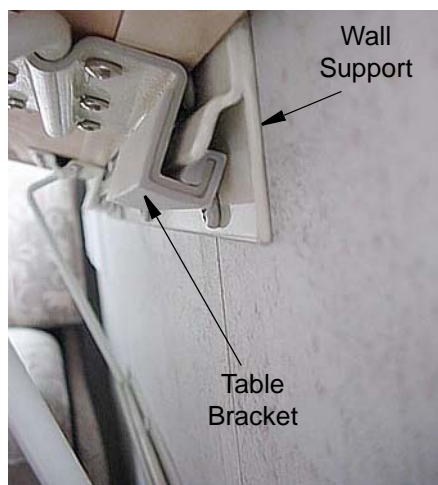

2. Make sure that the table leg is secured into the floor support bracket and the leg brace is locked.



---

---

### **DINETTE CONVERSION**

#### **-If Equipped**

**(Typical view – your coach may differ)**

#### **Dinette Table Setup**

1. Remove dinette table and pedestal leg from underneath the sofa.
2. Insert dinette pedestal leg into the metal receiver on the floor.

Your coach may be equipped with two metal receiver locations:

- One located in front the sofa.
- The other located behind the driver and passenger cab seats.

*NOTE: The cab seats must be completely rotated (facing the lounge area) to use as dinette seating. See the Driver/Co-Pilot Seat information in Section 3 - Driving Your Motorhome for complete operating instructions.*





- Place dinette table securely onto the dinette pedestal leg.

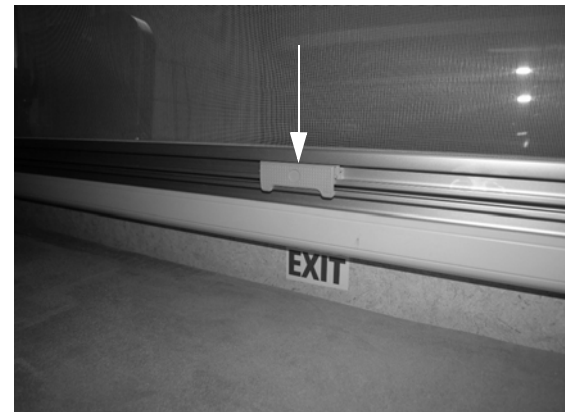

- To raise the translucent screen, pull bottom latch outward and let the screen retract.
- For daytime room darkening or nighttime privacy, pull entire shade upward to desired position.

---



---

## WINDOW SHADES/SCREENS

Your coach is featured with multi-positioning window shades and screens that can be used for light filtering, outside airflow, bug protection, daytime room darkening, or nighttime privacy.

- To lower translucent screen, pull the bottom of the screen straight down until the bottom latch “clicks” into position.

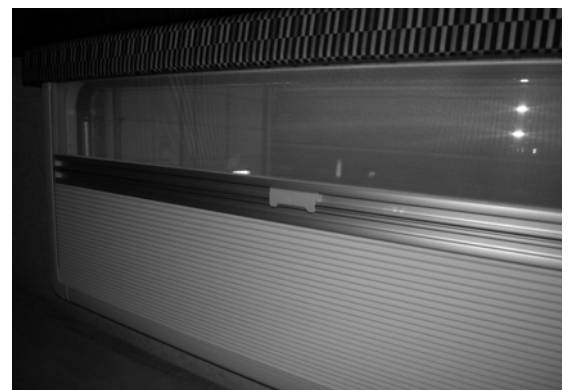

---

---

**ROLLER SHADES (MANUAL) -  
SOLAR DAY/NIGHT**

**–If Equipped**

Your coach may feature two-stage day/night roller shades that provide both solar heat protection and light-blocking capabilities.

The shade can easily be lowered by hand to any position, then retracted with a slight downward pull movement. When raising the shade, there is no need to hold onto the bottom of the shade - just simply let it go and it will rise at a slow, controlled rate.

You can pre-set the auto-stop positioning of your shade, which allows your shade to retract to a cushioned stop, at the positioning of your choice.



**Further Information**

For further operating information and care instructions, see the manufacturer's user guide provided in your InfoCase.

---

---

**WOOD FURNITURE AND  
CABINETRY**

**–If Equipped**

People are drawn to the natural beauty of wood. At Winnebago Industries®, our craftsmen work with the art found in each piece of wood to create cabinets of superior quality, backed by the Winnebago Industries warranty.

- Oak is a strong, open-grained hardwood that ranges in color from white to pink and reddish tones. Streaks of green, yellow, and even

black may appear due to mineral deposits. Oak may also contain wormholes and wild, varying grain patterns. This distinct graining is considered a desirable quality and has made oak one of the most popular woods used for cabinetry.

- Maple is a close-grained hardwood that is predominately white to creamy-white in color, with occasional reddish-brown tones. While maple typically features uniform graining as compared to other wood species, characteristic markings may include fine brown lines, wavy or curly graining, bird's eye dots and mineral streaks. These traits are natural and serve to enhance maple's natural beauty.
- Cherry is characterized by its red undertones, but may vary in color from white to a deep, rich brown. Cherry is a close-grained wood with fairly uniform texture, revealing pin knots and curly graining. All wood will age with time and the finish will darken. This is especially true for cherry. This is a sought-after quality in cherry cabinetry, and those who select it expect this evolution.

No matter which species you choose for your new Winnebago Industries motorhome cabinetry, please keep in mind that no two pieces of wood are exactly the same.

Stains are likely to exaggerate the difference between open and closed grains and other markings in wood. Grain variation and color change should be expected. As hardwood ages, it will darken when exposed to different types of light. Color differences or changes in wood can also be caused by exposure to harsh chemicals, extreme heat, or other contributing external conditions.

Any color change that occurs in both the finish and the wood is considered part of the natural aging process and is not to be considered defect or damage.

Additionally, wood species exhibit other defining characteristics, such as mineral deposits/streaks, knots, sap runs, pin holes, and wormholes. These markings make the wood unique and contribute to its enduring beauty.



Therefore, since wood is a product of nature and will have certain natural characteristics and variances, they are not covered under the warranty.



## SECTION 10 – SLIDEOUT ROOMS

### SLIDEOUT ROOM TRAVEL LOCK

#### -If Equipped

Some models are equipped with an expandable prop-lock rod device to restrict movement of the slideout room while the vehicle is in motion.

The Lock Rod **must be released before extending the room** or damage to the coach will result.

### NOTICE

Release and remove Slideout Prop-Lock Rod before attempting to extend slideout room. Damage to the vehicle will result if this is not done. Position and secure Prop-Lock before driving vehicle. See following instructions.

#### To Release Lock Rod

- Rotate the body of the cylinder to loosen and remove lock rod.



- Place T-shaped rod end against back side of slideout frame
- Rotate cylinder body to loosen or tighten ends
- Place flat plate end against coach sidewall

#### Slideout Room Prop-Lock Rod

Typical view of forward end of retracted slideout room directly behind driver seat. Your model may differ in appearance.

#### To Secure Lock Rod

- Place the flat plate end of the lock rod against the outer wall of the coach about 6" down from the top edge of the forward end of the retracted slideout room (behind the driver seat in most cases).
- Swing the T-shaped end of the rod into place against the back side of slideout room flange (frame) as shown.
- Rotate the cylinder body to tighten the lock rod snugly. During vehicle stops, check and retighten as necessary.

#### Master Keylock

A master keylock switch is located near the power switch for the front slideout room. This keylock must be turned on to provide power to the slideout control switches.



Slideout Room Keylock

The key to turn the master keylock “off” is attached to the lock rod. This is to remind you that the rod is removed prior to turning the switch.



SLIDEOUT ROOM OPERATION  
- ELECTRIC

 **WARNING**

Your motorhome may have more than one slideout room. Understand which switch operates which slideout room prior to operation. Make sure all slideout rooms are clear of people who could be harmed or obstacles that could cause damage prior to operating any slideout rooms. Failure to observe can result in death or serious injury.

Slideout rooms provide a spacious living area at the push of a button.

Front slideout room switches (if equipped) are located either on the dash, near the main entry door, or near the Systems Monitor Panel. Location varies by model and floorplan.

Rear slideout switches (if equipped) are located on a wall in the rear of the coach in or near the slide room. Location varies by model and floorplan.



Slideout Switches  
(Your coach may have one or more of these switches depending on model, options, and available equipment)  
-Typical View

 **CAUTION**

Never drive the vehicle with a slideout room extended!

The slideout room system uses 12-volt DC motorized mechanisms with an electronic control system to provide smooth operation and positive weather seal.

*NOTE: We recommend that you KEEP THE ENGINE RUNNING WHILE EXTENDING OR RETRACTING SLIDEOUT ROOMS so the engine alternator can provide maximum power for proper operation of the slideout mechanisms.*

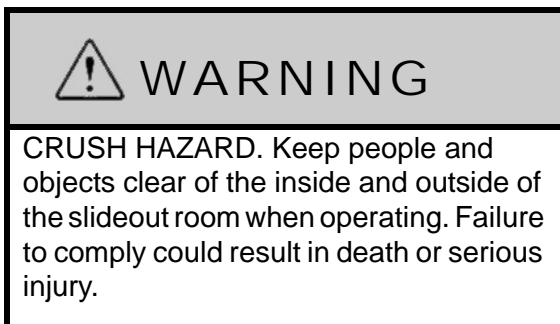

## To Extend Slideout Room

### Before Extending!

- Level the coach and set the Parking Brake.
- Release the travel lock or latch (if equipped) inside the coach. *See information at beginning of this section (if equipped).*
- Ensure exterior compartment doors are closed so that they will not interfere with slideout operation.
- Check inside and outside the vehicle to make sure that there are no people who could be harmed or obstacles that could cause damage due to room extension.
- If the slideout room has a couch or other furniture, make sure no people or pets are seated on them until the room has been fully extended.

## NOTICE

Release slideout room travel latch before attempting to extend slideout room.  
Secure travel latch before driving vehicle.

### Extend Procedure:

*See “Before Extending!” before proceeding.*

- Start the engine so the alternator can provide maximum power for proper operation of slideout mechanisms.
- Insert the Safety Lock key and turn to activate slideout room control switch.
- Press the Slideout Room “EXTEND/OUT” switch and hold until the room is fully extended, then release the switch.
- To stop extending the room during operation, release the button.
- Deactivate the slideout switch with the Safety Lock key.

## To Retract Slideout Room

### Before Retracting!

- Be sure the coach is level and the Parking Brake is set.
- Ensure exterior compartment doors are closed so that they will not interfere with slideout operation.
- Check inside and outside the vehicle to make sure that there are no people who could be harmed or obstacles that could cause damage due to room retraction.
- Stow all furniture extensions before retracting slideout rooms to avoid property damage.
- If the slideout room has a couch or other furniture, make sure no people or pets are seated on them until the room has been fully retracted.
- Remove all items from the coach living room floor and close cabinet doors and drawers. Be sure there are no items at the end of the bed, behind the driver seat, or protruding from

compartments, which could be crushed or cause damage to floor covering or cabinets when the room is retracted.

## NOTICE

Because the slideout roof is drawn into the interior of the coach when retracted, be sure there is no debris, such as excessive dirt, tree seeds, twigs, leaves, etc. on the roof before retracting.

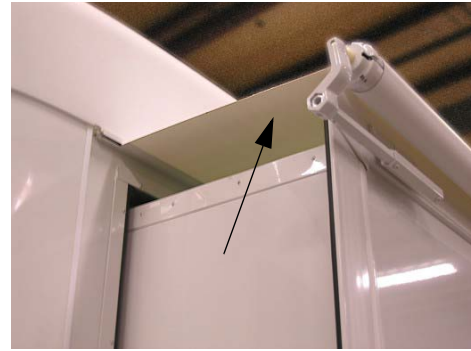

Slideout Cover-Awning  
-Typical View

### **Retract Procedure:**

*See “Before Retracting!” before proceeding.*

- Start the engine so the alternator can provide maximum power for proper operation of slideout mechanisms.
- Insert the Safety Lock key and turn to activate slideout room control switch.
- Press the Slideout Room “RETRACT/IN” switch and hold until the room is fully retracted, then release the switch.
- To stop retracting the room during operation, release the button.
- After the room is retracted, deactivate the slideout switch with the Safety Lock key, then refasten the travel lock or latch inside the coach (if equipped).

Also, freezing rain and snow can prevent the slideout cover-awning (if equipped) from closing and may cause damage to the cover-awning, slideout room, weather seals, and mechanisms.

To avoid potential damage, we recommend retracting your slideout room during extreme weather conditions.

---

---

## SLIDEOUT ROOM TROUBLESHOOTING (POWER GEAR®)

### **-If Equipped**

### **Battery Voltage or Circuit Breaker Problems**

#### **If the slideout room will not work**

- Turn the House/Coach Battery Disconnect switch OFF and then ON again. This will, in many cases, reset power to the slideout system.
- The house battery may be low on charge. Plug in the external power cord (shoreline), start the engine, or start up the generator (if equipped). This may assist slideout room operation.
- The chassis battery may be low on charge. Press and Hold the Battery Boost switch (located on the dash) while pressing the interior slideout control switch. This momentarily connects the house batteries to assist in slideout room operation.

---

---

## SLIDEOUT ROOM – EXTREME WEATHER PRECAUTION

Certain extreme weather conditions, such as heavy rains, heavy snow, and high winds, or any combination of these, could cause damage to the slideout room cover-awning (if equipped) or reduce effectiveness of the slideout room weather seals.

- The circuit breaker may be tripped. The circuit breaker labeled “Slideout Power” is located on a panel on an interior wall of the passenger side compartment just behind or ahead of the entrance door or on the side of the passenger seat base, depending on model.

**Problems Retracting the Room**

- Set the Park Brake if the Engage Park Brake light flashes while pressing the Retract (IN) button.

- Light will flash if park brake not set
- Light will flash fault code if system malfunctions



- Low Voltage Indicator

Slideout Touchpad  
-Typical View

If an error is detected on your slideout system, the LED light on the control panel will blink an error code. If an error code appears, see the manufacturer’s user guide in your InfoCase to determine the problem. The error code must be cleared prior to operating the room. To clear the error and reset the system:

- If none of the “Battery Voltage or Circuit Breaker Problems” troubleshooting recommendations reset the system, remove the touchpad from the wall (a screwdriver will be needed) and press and hold the RESET button (“Set Stops/Clear Fault”) located on the back of the touchpad for 5 seconds. The slideout is now ready to be retracted. Press IN on the touchpad to retract the room.
- Reinstall touchpad to the wall.
- Take your RV to an authorized service center for repair.

Before operating the room after an error has been detected, check for obvious faults such as obstructions prior to trying to operate the room again. If the error code appears again, the room will need to be retracted using either the manual retraction method or the fully manual method. Both methods listed below are intended as a means to retract the room to prepare the coach for travel to the nearest authorized service center.

**Manual Mode**

Manual Mode lets you individually move the two room arms (if equipped) by pressing the IN and OUT buttons on the touchpad. *This mode can be used only if there is not a motor failure or full electrical system failure.* To override the encoder and enter the Manual Mode, press and hold the RESET button (“Set Stops/Clear Fault”) located on the back of the touchpad until the two LEDs begin to flash.

While in the Manual Mode, each of the two room arms (if equipped) are activated by pressing and holding the IN and OUT buttons. The “OUT” button will retract the front arm. The “IN” button will retract the back arm. Both IN and OUT buttons may be held down at the same time to simultaneously activate both arms to retract the room. If one side of the room gets ahead of the other, release that button until the other arm catches up. The current limiting feature of the control still functions in the Manual Mode so each side can be fully retracted until it stops.

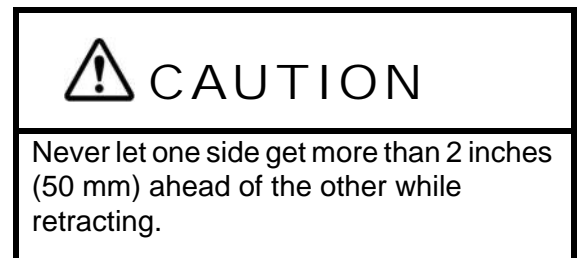

Once the room has been retracted, the control will return to the automatic mode after 60 seconds.

In the event of a total system failure where Manual Mode cannot be used, the crank-in method may be used to retract or extend the room. See *Slideout Emergency Retraction* elsewhere in this section.

### Problems Extending the Room

- Set the Park Brake if the Engage Park Brake light flashes while pressing the Extend (OUT) button.

- Light will flash if park brake not set
- Light will flash fault code if system malfunctions



- Low Voltage Indicator

Slideout Touchpad  
-Typical View

If an error is detected on your slide system, the LED light on the control panel will blink an error code. If an error code appears, see the manufacturer's user guide in your InfoCase to determine the problem. The error code must be cleared prior to operating the room. To clear the error, perform the following steps (one at a time) to reset the system:

- If none of the “Battery Voltage or Circuit Breaker Problems” troubleshooting recommendations reset the system, remove the touchpad from the wall (a screwdriver will be needed) and press and hold the RESET button (“Set Stops/Clear Fault”) located on the back of the touchpad for 5 seconds. The slideout is now ready to be extended. Press OUT on the touchpad to extend the room.
- If touchpad was removed, reinstall to the wall.
- Take your RV to an authorized service center for repair.

### Further Information

See the slideout room operating guide included in your InfoCase for further instructions and troubleshooting information.

---

### SLIDEOUT EMERGENCY RETRACTION (POWER GEAR®)

If the slideout mechanism is malfunctioning and the room will not retract using the interior control switch, you may need to access the motor/gear assembly and manually crank the room in to the travel position.

See “Accessing the Motor/Gear Assembly” for location on your model.

### Crank-In Mode

1. Disengage the motor brake, which appears as a flat “square” protrusion on the protective boot at the end of the motor. Move the brake lever slightly - about 1/8 turn counter-clockwise, or to left when facing end of motor (repeat for motor at other end of room, if equipped).
2. Disconnect the motor power lead from the wiring harness (repeat for motor at other end of room, if equipped).
3. Use a 3/4” socket and ratchet wrench on the motor gearbox shaft to crank the room in to the travel position.

*NOTE: If equipped with two motor/gearbox units, crank both sides of the room alternately and equally to avoid wedging the room.*

*If help is available, a second person (with a duplicate socket and ratchet) cranking the other end simultaneously will greatly speed up the process.*



- 1) Lift tab inside protrusion on boot to disengage motor brake

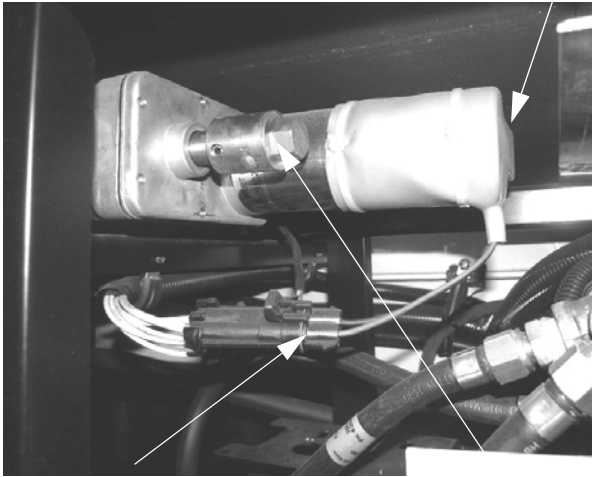

- 2) Disconnect motor power lead from wiring harness

- 3) Use 3/4" socket on gearbox shaft to crank room in

Slideout Motor/Gear Assembly  
-Typical installation shown

4. Crank the room in until it is just “snugged up.” Do not overcrank or you could damage the gear assembly.
5. While maintaining pressure on ratchet wrenches, re-engage the motor brake by moving lever clockwise slightly - or to right when facing end of motor (repeat for motor at other end of room, if equipped).
6. Reconnect motor power lead to wiring harness (repeat for motor at other end of room, if equipped).
7. Fasten slideout room travel latching device (if equipped) inside the coach before driving the vehicle.
8. See your dealer for service of the slideout mechanism before using again.

### Further Information

See the Slideout Room operating guide included in your InfoCase for further instructions and troubleshooting information.

## Accessing the Motor/Gear Assembly

### Model 25T

- Remove oval access panel inside front driver side compartment.

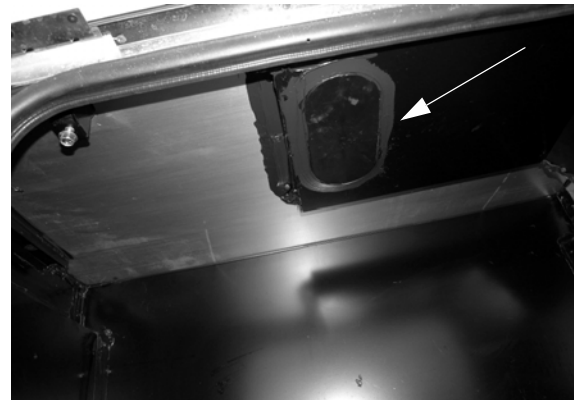

Motor/Gear Assembly Access Panel  
(Located inside driver side front compartment)  
\* Model 25T shown

### Model 25R

- Remove rear bed mattress.
- Remove bed frame/panel assembly by removing bolts around the perimeter of the bed.
- Flip up partition cabinet lid and remove access panel below.
- Below are two motor/gear assembly covers. Remove screws and lift off the panel on each.

### Model 25Q

#### Front Slideout Room

- Remove oval access panel inside front driver side compartment (same as Model 25T - see previous photo).

#### Rear Slideout Room

- Underneath rear bed - remove mattress and removable panel to access.

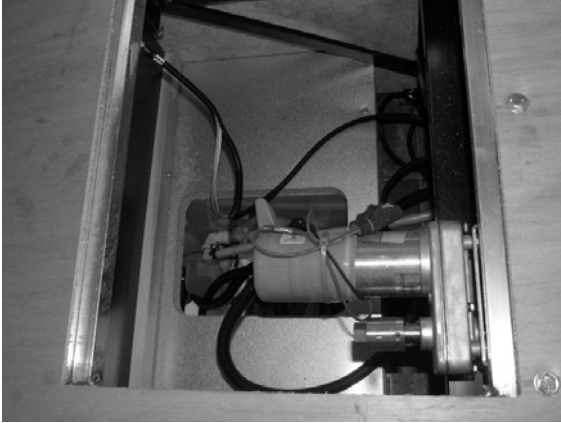

Rear Motor/Gear Assembly  
(Located beneath bed - remove mattress  
and removable panel to access)  
\* Model 25Q shown

---

---

## GENERAL SLIDEOUT CARE

- Keep slideout room seals clean.
- Clean the floors inside the coach before retracting the slideout room to avoid floor scratches or carpet pile snags.
- Wipe outer slideout room seals occasionally with talc or 303 brand protectant for smooth, quiet operation.
- See your authorized dealer for regular maintenance and service of the slideout mechanism.

### **Slideout Room Seal Care and Maintenance**

While most household cleaners work well for cleaning slideout room seals, certain chemical agents may cause the seals to degrade. Typically, 409<sup>®</sup> and Lysol<sup>®</sup> type products work well. Use a product, such as Armor All<sup>®</sup> to keep seals soft.

In addition, certain caulks and sealers may include chemicals that may adversely effect the performance of the seals. See your authorized dealer for caulks and sealers recommended for your coach.

## SECTION 11 – MAINTENANCE AND STORAGE

---

### SEALANTS – INSPECTION AND GENERAL INFORMATION

Water is a recreational vehicle’s worst enemy when it is allowed to enter where it is not intended. Sealants perform a very important function and should be inspected closely and maintained regularly. Winnebago Industries® utilizes many different types of sealants. Refer to the “Sealants Call-Out Sheet” provided in your InfoCase for further information.

Sealants, in general, do not have “set” lifetimes. Varying environmental factors affect the pliability and adhesiveness of sealants. You or your dealer must:

- Inspect all sealants, a minimum of every six months.
- Inspect the moldings, windows, clearance lights, exterior compartment doors, and all their attachments.
- Also, inspect weather seals around entrance door, etc., and if necessary, have a dealer replace them immediately.
- Check for cracks, voids, gaps, breaks, adhesion, and any sign of physical deterioration.

*NOTE: Proper sealant inspection includes not just visual observation but running a finger along sealant seams to verify proper adhesion to the surface. Any loosened areas must be replaced.*

- Have the sealant replaced if you notice any of the above. Your local Winnebago Industries dealer has the correct and necessary parts and experience to help you maintain your sealants. See “Sealants Call-Out Sheet” provided in your InfoCase.
- Always use the same type sealant that was removed.
- Immediately have dealership check moldings, windows, and exterior attachments for leak source if you notice water inside of unit.

### NOTICE

Sealants must be inspected every 6 months and replaced if necessary.

### ROOF

### WARNING

Stay off roof. Roof surface may be slippery. Falling could result in death or serious injury.

The roof is made of Thermo-Panel materials like the walls and floor. It will support the weight of an average adult for periodic maintenance or repair of the roof or roof mounted components.

Walking or working on the roof should be left to qualified service personnel using proper safety equipment in a safe environment. You should only walk or work on the roof if you are qualified and have created a safe environment.

For your safety, it is not recommended that you store or carry items on the roof.

Always have damage to the roof area repaired immediately. Damaged or detached sealant around the vents, air conditioner, body-to-roof seams, etc., should also receive immediate attention. Delaying these repairs may allow water leakage and result in damage to interior ceiling and body panels, upholstery, etc., which is not covered by the limited warranty (see *Section 1 - Introduction*).

### UNDERCARRIAGE

Buildup of mud and dirt under the body of the vehicle can cause damaging rust or corrosion on steel or aluminum parts and can add needless

weight to the vehicle. This, in effect, reduces the amount of cargo you can carry and remain within GVWR and GAWR limits.

Corrosive materials, such as those used for ice and snow removal and dust control, can also accumulate on the underside of a vehicle. These materials should be removed by flushing the undercarriage regularly with water, especially horizontal surfaces, cavities, and other areas where mud and other deposits may collect.

---

---

### EXTERIOR AUTOMOTIVE PAINT FINISH

The body of your coach is fully or partially finished with the highest quality automotive paint and clearcoat. Follow these precautions to keep the finish on your coach looking its best and preserve maximum gloss and durability.

#### Parking

- **Avoid parking under trees** – When this happens you should rinse the bird droppings and tree sap off as soon as possible. Tree sap is a form of sugar and will dissolve after a couple of rinses. Bird droppings can eat into a painted surface if left unattended and need removed as soon as possible. Lukewarm soapy water can help speed up the cleaning process.
- **Avoid parking near salt spray** – When this happens you need to rinse off the salt mineral residue to minimize the corrosiveness of the salt.
- **Avoid parking near factories with heavy smoke or industrial fallout** – Industrial fallout can eat into your coaches finish when dew or rain mixes with it to create nitric or sulfuric acid that gets magnified by the intensity of the sun. As the water evaporates, the acid becomes more powerful and attacks the painted surface.  
Rinsing and washing the surface helps remove the fallout and neutralize the acid. After the initial 60-day cure stage, a coat of wax or polish can help protect the surface from these types of contaminants.

- **Do not scrape ice or snow from the painted surface.** Brush off gently with a soft-bristled snow brush – avoid being forceful with the brush.  
If brush scratches show after the motorhome thaws out, it may be possible to remove them by hand waxing with a silicone-free liquid wax.
- **Avoid covering painted surface.** When paint is covered (especially in outdoor conditions), water may appear between the cover and the vehicle due to rapid temperature fluctuations. The water may vaporize under certain conditions and migrate into the painted surface, possibly resulting in blisters and/or bubbles in the paint. These blisters/bubbles are not covered under warranty.  
Covering your RV is at owner's risk.

#### Driving

- Avoid driving on gravel roads.
- Rinse off bugs and bird droppings with water daily.
- Antifreeze, fuel, or windshield/window solutions spilled on the painted surface should be rinsed off immediately with water and allowed to air dry. Wiping dry with a towel may create fine scratches due to the solvent nature of these types of fluids.
- Fuel cannot be diluted and dissipated with water. It must be removed with a mineral spirit type cleaner (such as *SEAFOAM Bugs-B-Gone*, or equivalent) or a silicone-free spray wax and microfiber cloth to remove the stain left by fuels.
- Ensure that all RV fluids (such as gas, oil, grease, antifreeze, transmission fluid, brake fluid, etc.) are completely wiped off of painted surfaces. Failure to comply may cause the paint to blister and/or peel.

*NOTE: When driving in wintry conditions, the road surface may be covered with heavy salts or small rocks to improve road traction. These types of road conditions can cause undue surface damage to your RV. Please refrain from driving in these conditions.*

## Washing

- Commercial vehicle wash facilities should be strictly avoided! They will scratch your RV!

*Truck-style wash centers have high-pressure wands that emit higher than necessary water pressures and the brushes are very aggressive.*

*Most truck wash brushes are made from a heavy plastic for durability and are under heavy pressure. They are designed to clean heavy road films on semi trailers and are often dirty. They are not designed for custom painted RV's and they will scratch the clearcoat finish.*

*Many times these scratches can penetrate the clearcoat finish, possibly causing delamination and/or other paint related issues that are not covered under warranty.*

- Wash your RV with cool or lukewarm water using a mild soap (such as a baby shampoo) that does not contain bleach solution. Most auto stores offer car wash detailing soaps that are similar and do not have bleach in the formulation (such as Meguiars #62).
- Never use a bristled brush or broom to wash the painted surface. This will cause scratches in the finish. Using a microfiber cloth, mitt, or mop is strongly recommended.
- Be sure your cloth or applicator is clean. A dirty applicator can scratch your RV.

## Washing Procedure

- Rinse area to be washed with cold water to remove surface residue. Ensure you are not in direct sunlight.
- With area to be washed still wet from the rinse, use the recommended soapy mixture to clean the area. To avoid scratching painted surfaces, a microfiber cloth, mitt, or mop is strongly recommended to apply soapy water.
- Rinse washed area before soap evaporates.
- Dry the rinsed area before the water evaporates.

*NOTE: Avoid aiming water flow from a hose or spray from high-pressure washing equipment into any appliance intake, as damage or difficulty in operating appliances may occur.*

- After washing the coach, carefully inspect sealant around window frames, vents, and any other joints that may have loosened or separated. See “Sealants - Inspection and General Information” at the beginning of this section for details.

## Bug Removal

- Rinse any loose debris off with water and allow the remaining residues to soak and soften. Use soap and water to wash the residue, then rinse.

*NOTE: You may wish to repeat and leave soap on longer than normal to help with softening hardened residue.*

- For more stubborn areas, use an ammonia-based glass cleaner followed by washing with warm soapy water, then rinse.
- Remember to use microfiber towels during this process to help avoid scratches.
- If this does not work, as a last resort, use a bug removal product (like SEAFOAM Bugs-B-Gone, or equivalent) in a shady area and follow the directions on label. Ensure cleaner is completely wiped off of painted surfaces. Failure to comply may cause the paint to blister and/or peel.

## Polishing and/or Waxing

*NOTE: When your coach is new or has been repainted for any reason, no polish or wax should be applied to the finish until after a 60-day cure cycle at temperatures higher than 60 degrees for 60 days. Failure to observe this precaution could void your paint warranty.*

- We recommend a silicone-free polish with an orbital machine and terry cloth applicator.
- Liquid waxes are easier to apply and bring to a gloss with fewer residues.

- Avoid paste waxes. They sometimes have fillers and additives that give a very short term result. Stay away from silicones in polishes and soaps.
- Buffing compounds remove some of the mil film of the clearcoat, so we recommend that only professionals or very experienced users apply this type of product.

### Inspection

A motorhome exterior is subjected to many physical forces and environmental conditions. While the coach is parked, it is exposed to climate and weather extremes and other environmental conditions. While in operation, it is subjected to various twisting and flexing forces caused by routine cornering and turning, and by uneven road surfaces, such as bumps, potholes, railroad tracks, and parking lot entrances.

Inspect the exterior fiberglass shell periodically for cracks which may represent a threat to the integrity of the fiberglass.

Minute cracks in the surface (commonly referred to as "spider cracks" or "hairline cracks") caused by normal flexing of the fiberglass exterior are normal and typically pose no threat to the integrity of the vehicle other than appearance.

However, if a crack has opened up and the weave of the cloth is visible, this does represent a threat to the integrity of the fiberglass and must be repaired or covered as quickly as possible to avoid penetration by moisture, especially in freezing climates.

If the fiberglass has been damaged and contains cracks, tears, or holes, use plastic sheeting and duct tape, if necessary, to prevent moisture from damaging the sidewall material or the interior of the coach.

### Protective Film -If Equipped

Your coach may be equipped with a protective film to defend against everyday road hazards. This film creates a barrier against bugs, road grime, bird droppings, and other harmful elements.

### Further Information

See the manufacturer's information provided in your InfoCase for complete care and maintenance instructions.

---

---

## EXTERIOR GRAPHIC CARE

The pressure-sensitive graphics on your vehicle require very little maintenance. In order to allow the graphics to have the longest life possible, the following steps should be taken.

- Wash graphics with plain soap and water or any car wash detergent. Rinse thoroughly.
- High pressure water spray may loosen or damage graphics. Keep spray nozzle at least 1 1/2 feet from the edge of the graphics.
- Test any cleaning solution on a small section of graphic before using.
- Never use aromatic solvents such as acetone, M.E.K., toluene, paint thinner or lacquer thinner on graphics. Solvents may soften the vinyl and smear colors.
- Gasoline or other fuels spilled on graphics should be rinsed off immediately with water.
- Do not apply paint or clearcoat over the graphics.
- Do not apply wax over the graphics, especially wax containing petroleum distillates. Wax that has dried along the edge of a graphic can be removed with cotton swabs after softening it with isopropyl alcohol. Rinse area thoroughly after cleaning.

---

---

## PLASTIC PARTS – CLEANING

Many parts in your vehicle, such as the dash, exterior light lenses, and certain exterior body panels are made of high-impact plastic materials that can be damaged by wiping with solvents or improper cleaning products.

Always try cleaning plastic parts with the mildest cleaners first and work your way up to stronger cleaning products. Use the following cautionary lists as a guide when selecting cleaning products to use on plastic parts.

## NOTICE

Do not use citrus-based cleaners on polycarbonate finishes. Citric compounds will damage the high-gloss surface, causing it to appear dull or “flat”. Always test a cleaning product on a hidden area to be sure it will not cause damage to the appearance of the part.

Here is a list of mild cleaners that **may be used safely**:

- Car washing soap and water
- Glass cleaners *without ammonia*
- Mineral oil
- Multipurpose cleaners (such as Fantastik<sup>®</sup>, Formula 409<sup>®</sup>, etc.)

The following products, compounds, or solvents must be **wiped off immediately** to avoid damage:

- Ammonia
- Brake fluid
- Bathroom basin, tub, and tile cleaners
- Chlorine
- Ethyl alcohol
- Isopropyl (rubbing) alcohol
- Kerosene or gasoline
- Naphthalene
- Pine-type household cleaners

**Do not use** cleaners containing the following products, compounds, or solvents. These products **will damage** the finish.

- Acetic acid
- Acetone (nail polish remover)
- Aromatic solvents (lacquer thinners)
- Benzene
- Butyl alcohol

## EXTERIOR LIGHTS

Most Winnebago Industries<sup>®</sup> vehicles have polycarbonate lenses on exterior lamps, which are very sensitive to a variety of chemical solvents and cleaners.

Use only soap and water to clean exterior lamp lenses, especially headlights.

- Contact with certain chemicals can cause etching, “crazing” or cracking of the lens, which can significantly reduce the lens clarity and effectiveness of the lamp and may require replacement of the complete lamp housing.
- Some popular citric acid cleaners may cause polycarbonate lenses to become “hazy” or “foggy”.
- Do not use a pressure washer to clean headlights.
- Inspect and operate the lights regularly to confirm proper operation and mounting condition.

## INTERIOR SOFT GOODS

We recommend a weekly routine of vacuuming all fabrics and carpet throughout the motorhome to prevent an accumulation of dirt, which can detract from the appearance and shorten the life of carpet and fabrics.

## Fabric Upholstery

Some fabrics used in this motorhome may contain fire retardant and lightfastness additives, which can be damaged by use of improper cleaning products. Some water-based household cleaning products are not formulated for use on fabrics and may cause excessive shrinkage or fading. Always test any cleaning product on a hidden area of fabric before using on visible areas. For best results, fabric cleaning should be referred to a professional carpet and upholstery cleaner.

*NOTE: To minimize fading of upholstery, carpets and other interior fabrics caused by excessive sunlight, the drapes, blinds, or*

## SECTION 11 – MAINTENANCE AND STORAGE



*shades should be closed when the motorhome is parked for an extended period of time.*

WARNING

When cleaning upholstery and fabric, do not use lacquer thinner, nail polish remover, laundry soaps, or bleach. Never use carbon tetrachloride, gasoline, or naphthalene for any cleaning purpose. These materials may cause damage to the material being cleaned and most are highly flammable, posing risk of injury due to fire.

### Bunk Liner Fabric

If the bunk upholstery fabric becomes stained or soiled, spot clean the stain with mild soap and water. Stubborn, heavy soiled stains may be treated with a solvent cleanser, such as Mopar<sup>®</sup> Super Kleen.

### Ultraleather™ Leather-Like Upholstery –If Equipped

Ultraleather synthetic leather fabric material has the luxurious look and feel of the finest European calfskin, with the durability and resistance to soils and stains of vinyl fabrics. It is also tougher than real calfskin and has superior resistance to punctures, snags, and rips.

For most soils and stains, the fabric manufacturer recommends spot treatment with a solution of water and Tide<sup>®</sup> brand laundry detergent or equivalent. More stubborn stains may be treated with a water-based multipurpose cleaner/degreaser such as Simple Green<sup>®</sup> or equivalent. Solvent cleaners such as nail polish remover or other aromatic solvents are not recommended.

### Care Instructions

- Spot clean with mild soap and water.
- Air dry or, if desired, dry quickly using a hair dryer on warm setting - not hot.

- For stubborn stains, use cleaner-degreaser.

UltraLeather Cleaning Chart		
Type of Stain	Detergent/ Water	Cleaner/ Degreaser
Coffee, Tea	◆	
Red Wine, Liquor	◆	
Cola, Soft Drinks	◆	
Milk	◆	
Ketchup	◆	
Steak/Soy Sauce	◆	
Mayonnaise, Butter	◆	◆
Salad Oil	◆	◆
Chocolate	◆	◆
Cosmetic Makeup	◆	◆
Lipstick	◆	◆
Face Cream	◆	◆
Suntan Oil/Lotion	◆	◆
Shoe Polish	◆	◆
Urine	◆	◆
Machine Oil		◆

### Vinyl Fabrics (including ceiling) –If Equipped

Vinyl should be cleaned with a soft, damp cloth, and a mild detergent only. Do not use solvents. Solvents may damage the surface of the vinyl.

### Draperies, Curtains and Bedspreads

These items may be woven from a variety of fabrics. We recommend that these be professionally dry cleaned only. A five percent shrinkage may occur when you have these items dry cleaned.

### General Stains

As with any stain or contamination, the quick response is the best, especially when done in conjunction with the proper cleaner for the type of stain.



---

---

## CABINETRY – CLEANING

Wooden items may be cleaned with a soft cloth and a good quality wood finish cleaning product.

Vinyl simulated wood panels may be cleaned with a mild, water-based cleaner and a soft cloth. Do not use solvents on vinyl wood panels.

*NOTE: Many cabinetry and furniture items throughout this motorhome are constructed either partially or completely of real hardwoods. Because of natural variations in woodgrain density, slight differences in stain hue may exist between one item and another. This is the distinctive character and beauty of real wood.*

---

---

## TABLES AND COUNTERTOPS

Work surfaces are covered with a plastic or thermo-formed laminate that resists solvents, stains, and abrasions. A coat of furniture wax applied to these surfaces on the counters and table will help preserve their beauty and make cleaning easier. Always clean the surface before applying wax.

---

---

## STAINLESS STEEL APPLIANCES

### -If Equipped

### Care and Maintenance

You can easily maintain the beauty of your stainless steel appliances with little effort, under most circumstances, by performing the following recommendations.

Typically, excellent results can be obtained by washing stainless steel with mild dishwashing liquid and hot water, followed by rinsing thoroughly and drying with a soft cloth. Drying is particularly important if the tap water is very hard and leaves scale deposits.

Stainless steel does not deteriorate due to frequent cleaning, so proper cleaning can be performed whenever necessary. For more

stubborn stains, perform the following procedures for your stainless steel appliances to start shining again.

### Scale

To remove scale left by water, simply use a multipurpose cream detergent and a soft cloth. Thicker scale may be removed by generously applying 25% vinegar and hot water solution to the stain. Rinse thoroughly with a sodium bicarbonate and water solution, then follow up by rinsing with water. Clean carefully.

### Oil and Grease Stains

To remove oil and grease stains, use a mild dishwashing liquid and hot water. Rinse thoroughly with clean water and dry with a soft cloth. For more stubborn stains, ethyl alcohol, acetone, or another non-halogenated solvent may be used with care.

### Stubborn Dirt and Burnt Grease

Use a multipurpose cream detergent and a soft cloth.

### Coffee and Tea Stains

Prepare a sodium bicarbonate solution and hot water. Apply generously to stain and let sit for 15 minutes. Rinse thoroughly and dry with a soft cloth.

### Rust Stains

Apply a multipurpose cream detergent and rub delicately with a soft cloth. If stain persists, it may be necessary to apply a stainless steel-specific product.

### Fingerprints

Use a mild dishwashing liquid and warm water. Rub delicately with a soft cloth. Window cleaner may also be used.

### Scratches

Apply a stainless steel-specific detergent/polisher and buff with a soft cloth.

### Important “Don’ts”

- Do not use hydrochloric acid or any other detergents containing chlorides on stainless steel.

- Do not use abrasive powder detergents that could ruin the surface finish.
- Do not use wool, abrasive brushes, or tools that have previously cleaned other metals, because as well as scratching the surface, they can generate contamination and unattractive stains.
- Do not use silver cleaners.

---

---

## GALLEY SINK

### Stainless Steel

#### Care and Cleaning Instructions

The stainless steel sink can usually be cleaned with water and soap or detergent using a soft cloth or sponge.

- **Rinse thoroughly** with warm water and wipe dry quickly to avoid spots and streaks.
- **For stubborn stains**, use a mild abrasive cleanser like Soft Scrub<sup>®</sup>, Comet<sup>®</sup>, etc. Work in the direction of the “grain” of the brushed finish lines.
- **Never use steel wool.** Particles of steel from the wool pad can embed into the sink surface, then become rusty and unsightly.
- **Avoid contact with full-strength** bleaches, household chemicals, and acid-based cleaners. If this happens, rinse and wipe dry quickly.
- **Salt, mustard, and mayonnaise** can cause pitting if left on the steel sink surface. If spilled, clean and rinse immediately.
- **A high iron content** in the water (hard water) may result in a brown or rust-colored stained appearance. If noticed, dry towel sink after each use.
- **Do not use rubber mats** in the sink bowl. Material trapped under mats can complicate cleaning.

*NOTE: Improper use may damage this product and void the warranty.*

---

---

## RANGE AND REFRIGERATOR

For care and appearance maintenance of the range and refrigerator, refer to the appliance manufacturer’s operation and maintenance manuals included in your InfoCase.

---

---

## VINYL FLOORING

### Care and Maintenance

You can easily maintain the beauty of your vinyl flooring with little effort, by following these recommendations:

- Sweep or vacuum floor daily (use a vacuum without a beater bar head.) Remove loose dirt with a soft brush or Swiffer<sup>®</sup> type product.
- For more intense cleaning, use a non-abrasive cleanser, such as Mr. Clean<sup>®</sup>. Rinse with clean water.

*NOTE: Floor cleaners containing waxes, brighteners, or gloss agents are not recommended.*

- Regular cleaning with solvent-based chemicals may adversely affect the topcoat performance.
- Do not use undiluted bleach or leave a dilution of bleach on the floor for longer than one hour.

### Maintenance Tips

- Install protection (such as pads or casters) on furniture with legs or sharp edges. This protection should not contain bitumen, which may cause brown stains.

*NOTE: Faulty pads and casters should be removed and replaced.*

- Burning cigarettes and matches can cause damage to the flooring.
- Use doormats (that do not contain bitumen) to keep out most of the dirt and dust.
- Remove spills immediately with a damp cloth, followed by rinsing with clean water.
- The use of stiletto heels is not recommended, as they may cause permanent damage to the flooring.

- Protect flooring from prolonged direct sunlight exposure.

### Treatment of Stains

**Acids, alkali, alcoholic beverages, coffee, soft drinks, ketchup, fruit, fruit juices, food, vegetables, mustard, ink, and iodine:**

- Remove the stain with lukewarm water and a cloth or sponge. If necessary, clean with a soft nylon pad and non-abrasive mild detergent or resilient floor cleaner.

#### Heel marks:

- Clean as soon as possible with a soft nylon pad and non-abrasive mild detergent or resilient floor cleaner.

**Asphalt, candle grease, chewing gum, fat, oil, tar, and shoe polish:**

- Gently remove with a blunt instrument and treat with a soft nylon pad and non-abrasive floor cleaner.

#### Lacquer and nail polish:

- Remove as soon as possible. Do not allow to dry. If necessary, apply nail polish thinner (sparingly) to remove any residue.

#### Corrosion, paint, and grass stains:

- Treat as soon as possible with a soft nylon pad and non-abrasive mild detergent or resilient floor cleaner.

#### Varnish, oil paint, and solvents:

- Blot up as soon as possible. Do not rub, as this will only spread material further across the surface. Carefully treat with a mild cleanser. When dry, carefully peel the stain off. MEK may be used sparingly, if necessary. Rinse immediately with clean water.

#### Pet stains:

- Treat with lukewarm water. If stain remains visible, clean with a soft nylon pad and non-abrasive resilient floor cleaner.

---

---

## BATHROOM

### Toilet

For instructions on the care of your toilet, refer to the information in your InfoCase.

### Tub and Shower Walls

The tub and shower walls in the bathroom should be cleaned with mild soap and warm water. Do not use an abrasive cleaner on the shower walls and tub, as scratching and discoloration may occur. Stubborn stains may be removed with an automotive-type cleanser.

### Lavatory Sink

The lavatory sink is made of the same material as the galley sink. See Galley Sink - Care and Cleaning Instructions.

---

---

## DOORS AND WINDOWS

Windows may be periodically cleaned with a good quality glass cleaner or mild soap solution using a soft cloth.

Use care when removing ice or frost from the windows. Always use a plastic ice scraper, never one made of metal. Use care when removing ice from the mirrors to protect the reflective surfaces.

Door locks and hinges should be lubricated periodically with powdered graphite to ensure trouble-free operation and to protect against freeze-up.

---

---

## VEHICLE STORAGE – PREPARATION

Properly preparing your vehicle for storage will lessen the possibility of damage to your vehicle. Prepare the motorhome for vacancy just as you would if you were leaving your house for an extended period.

### Clean and Prep Coach for Storage

1. Turn off the propane gas tank.
2. Turn the furnace thermostat switch OFF.
3. **Remove all foods and items that may cause odors from cabinets and refrigerator.**

## SECTION 11 – MAINTENANCE AND STORAGE



4. Clean and defrost the refrigerator. Prop the door open slightly to allow any odors to dissipate. Place an open box of baking soda inside the refrigerator to help absorb odors.
5. **Fully charge the batteries. Batteries must have at least 80% charge to survive freezing temperatures and long period of non-use.** We recommend that you connect a battery charger or plug in the shoreline once a month during long-term storage periods to maintain battery charge and to avoid sulfating. If connecting a charger directly to batteries, turn the House/Coach Battery Disconnect switch off to avoid electrical arcing when attaching and detaching charge clamps.

*NOTE: We do not recommend leaving the shoreline plugged in continuously during storage.*

6. After charging batteries, turn the House/Coach Battery Disconnect switch off to disconnect the batteries and avoid parasitic\* drain.  
*\* Parasitic battery drain is the gradual drain by items connected directly to battery power such as clocks, radio memory, and the engine computer.*
7. Have the vehicle chassis completely serviced and lubricated. Be sure radiator antifreeze protection level is sufficient for the lowest anticipated temperatures.
8. Wash and wax the coach.
9. Inspect all seams and seals around doors, windows, vents, and any other joints. Replace or repair any that are damaged. Sealing materials and compounds can be purchased from your dealer. Badly damaged weather seals may need to be replaced by your dealer.
10. Close all windows and roof vents. Protect all appliance vent openings from contamination by animals or insects (e.g. bird nest, wasp nests, etc.)
11. Lubricate all door hinges and locks.
12. Clean the interior of the coach. Dirt and stains are more easily removed when fresh.

13. Follow “Vehicle - Leaving in Storage” suggestion in chassis owner’s manual included in your InfoCase.

If you are storing your vehicle through the winter, or in cold climates, extra preparations must be made to protect equipment and systems that can be damaged by freezing temperatures. See *Winterizing Procedures* in Plumbing section.

---

---

## VEHICLE STORAGE – REMOVAL

1. Completely air out the motorhome.
2. Have the entire LP gas system checked for leaks.
3. Check window operation.
4. Check cabinet and door hinges. Lubricate with penetrating oil, if necessary.
5. Close all faucets and drain valves that are open.
6. Add a few gallons of water to the fresh water tank and turn on the water pump to check for leaks, especially at fittings.
7. Open all faucets in turn to release trapped air and check to be sure faucet washers have not hardened during storage.
8. Sanitize the water system as outlined under *Disinfecting the Fresh Water System* in the Plumbing section, then flush the waterlines thoroughly with fresh water.
9. After flushing fresh waterlines, install a new water filter cartridge on the galley sink water filter and/or full-coach water filtration system (if equipped). See appropriate filter installation instructions in Plumbing section.  
*NOTE: Always purge a new filter with clean running water before using. See filter manufacturer’s directions included with the filter cartridge.*
10. Check the toilet for proper operation.
11. Add water to the holding tank using the toilet flush pedal and galley sink faucet. Check to be sure dump valves seal tightly.
12. Check around all appliances for obstructions and ensure that all vent openings are clear.

13. Start refrigerator and check for proper cooling.
14. Clean wall and counter surfaces.
15. Replace batteries, if necessary, and check out electrical system to make sure all lights and electrical components operate.
16. Check tires for proper cold inflation pressure. See “Vehicle Certification Label” in *Section 1 - Introduction*.
17. After washing accumulated winter grime from the vehicle, it is important to carefully inspect the seams and sealants for separation or cracks that may have appeared around the window frames, vents, and any other joints. See *Sealants – Inspection and General Information* at the beginning of this section. Resealing is quite simple and the material is quickly and easily applied. Appropriate compounds are available from your dealer. See the *Sealants – Recommended Application* page in the Supplement Manual provided in your InfoCase.  
Also inspect weather seals around doors, etc., and if necessary, have a dealer replace immediately.

---

---

## CHASSIS SERVICE AND MAINTENANCE

Consult the appropriate sections in your chassis manual for specific information regarding operating safety, service recommendations, and maintenance schedules for the chassis section of your vehicle.

# SECTION 11 – MAINTENANCE AND STORAGE



## COACH MAINTENANCE CHART

These recommendations apply for normal recreational use. Heavy duty or full-time use may require more frequent maintenance intervals.

Always use specified sections or manufacturer's guide for further information and instructions.	Before Each Use	Weekly	Monthly	Every 3 Months	Every 6 Months	Every Year	As Necessary
<b>Propane Gas System</b>							
Have propane gas system checked for leaks						◆	◆
Pressure Regulator - inspect and adjust if needed						◆	
Check propane tank condition, mounting, and fittings						◆	
<b>Electrical System</b>							
Check Battery Condition Meter	◆						
Check battery fluid level and connections			◆				
Check 12V fuses and 120V breakers							◆
Check GFCI receptacles			◆				
<b>Generator</b>							
Visually inspect generator and compartment	◆						
See generator manufacturer's maintenance guide							◆
<b>Plumbing System</b>							
Sanitize plumbing system							◆
Winterize plumbing system							◆
Clean water pump strainer filter						◆	◆
<b>Slideout &amp; Leveling System</b>							
Check and adjust							◆
Check hydraulic oil level			◆				◆
Check hydraulic lines (routing, leaks, etc.)						◆	
Inspect slideout room seals (bulb seals), clean as necessary				◆			
Check and inspect electric slideout lock drain line(s)							◆
<b>Exterior</b>							
Clean roof				◆			◆
Clean sidewalls			◆				◆
Clean windows							◆
Flush underside of vehicle				◆			◆



### COACH MAINTENANCE CHART

These recommendations apply for normal recreational use. Heavy duty or full-time use may require more frequent maintenance intervals.

Always use specified sections or manufacturer's guide for further information and instructions.	Before Each Use	Weekly	Monthly	Every 3 Months	Every 6 Months	Every Year	As Necessary
<b>Safety Equipment</b>							
Check operation of the following items:							
Headlights, Taillights, and Marker Lights	◆		◆				
Turn Signals	◆		◆				
Horn	◆		◆				
Hazard Warning Flashers	◆		◆				
Windshield Wipers and Washers	◆		◆				
Fire Extinguisher - check charge indicator	◆		◆				
Smoke Alarm - test operation *	◆		◆				
Carbon Monoxide Alarm - test operation *	◆		◆				
Propane Gas Leak Detector - test operation (*replace battery if needed)	◆		◆				
<b>Appliances</b>							
<b>Water Heater</b>							
See water heater manufacturer's maintenance guide							◆
Inspect and clean exterior vent	◆						◆
<b>Refrigerator</b>							
See refrigerator manufacturer's maintenance guide							◆
Inspect and clean exterior vent/drip tray drain tube	◆						◆
<b>Furnace</b>							
See furnace manufacturer's maintenance guide							◆
Inspect and clean exterior vent	◆						◆
<b>Air Conditioner</b>							
See A/C manufacturer's maintenance guide							◆
Inspect for exterior damage				◆			◆
Check/replace filter			◆				
<b>Range Top</b>							
See range manufacturer's maintenance guide							◆
Inspect and clean/replace range hood grease filter							◆

# SECTION 11 – MAINTENANCE AND STORAGE



## COACH MAINTENANCE CHART

These recommendations apply for normal recreational use. Heavy duty or full-time use may require more frequent maintenance intervals.

Always use specified sections or manufacturer's guide for further information and instructions.	Before Each Use	Weekly	Monthly	Every 3 Months	Every 6 Months	Every Year	As Necessary
<b>Sealants</b>							
Inspect (see "Sealants - Inspection and General Information" at the beginning of this section for proper inspection technique)					◆		◆
Replace (see "Sealant Call-out Sheet" in the supplement manual provided in your InfoCase)							◆
<b>Frame &amp; Chassis</b>							
Follow chassis manufacturer's maintenance guide (refer to chassis manual)							◆
Inspect hitch receiver (if towing)	◆						
<b>Tires</b>							
Check and adjust air pressure	◆						◆
Check tread wear	◆						◆
Check front end alignment and adjust if needed							◆
<b>Miscellaneous</b>							
Lubricate locks, hinges, and latches						◆	◆



## SECTION 12 – MISCELLANEOUS

---



---



---

### LOADING THE VEHICLE

*NOTE: Your motorhome's load capacity is designated by weight, not by volume, so you cannot necessarily use all available space when loading your motorhome.*

- Store or secure all loose items inside the motorhome before traveling. Possible overlooked items such as canned goods or small appliances on the countertop, cooking pans on the range, or free-standing furniture items can become dangerous projectiles during a sudden stop or evasive maneuver.
- Be aware of GVWR, GAWR, and individual load limit on each tire or set of duals.

When loading the vehicle, distribute the cargo load equally so that you do not exceed either the Front or Rear Gross Axle Weight Rating (GAWR) or the Gross Vehicle Weight Rating (GVWR). The Gross Axle Weight Rating (GAWR) means the weight value specified by the chassis manufacturer as the load carrying capacity of a single axle system as measured at the tire-to-ground interfaces. This is the total weight a given axle is capable of carrying. Each axle has its own rating.

Have your vehicle weighed to determine the proper load distribution for your vehicle. Also distribute cargo side-to-side so the weight on each tire or dual set does not exceed one half of the GAWR for either axle.

For example, if the Front GAWR is 6,000 lbs., there should be no more than 3,000 lbs. on each tire. (If the left side weighs 3,100 lbs. and the right side weighs 2,700 lbs., at least 100 lbs. of the load must be shifted from the left side to the right side.) The GVWR is listed on the Vehicle Certification Label. (See sample in *Section 1 - Introduction*).

The GCWR (Gross Combination Weight Rating) means the maximum allowable loaded weight of this motorhome and any towed trailer or towed vehicle.

*NOTE: We recommend that you dump all holding tanks before traveling to avoid carrying unnecessary weight.*

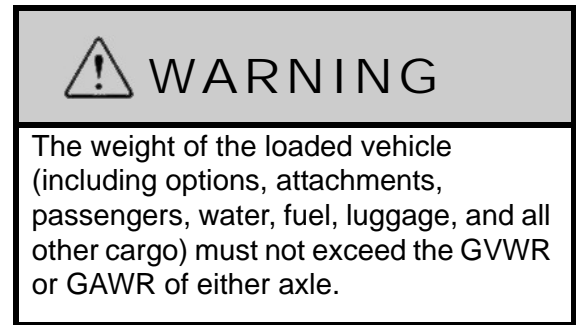

---



---

### WEIGHING YOUR LOADED VEHICLE

To check the weight of your fully loaded coach, locate a commercial weighing scale that is capable of weighing large trucks.

*NOTE: Sales literature may give approximate or standard weights. Your actual coach weight may differ based on added factory and/or dealer options.*

#### Loading

Load your vehicle completely as if you were going on a long trip with everything you would carry, including food, clothing, bedding, lawn chairs, etc., a full fuel tank, full propane tank, and a partial tank of fresh water, but empty holding tanks.

#### Finding a Scale

In urban areas, the most common places to find a public access scale are commercial truck stops. In rural areas, most grain storage elevators have scales available. Most scales charge a nominal fee for weighing a vehicle.

#### Weighing

There is typically a scale operator to direct you, but the basic routine is to take three separate weights - front axle, whole vehicle, and rear axle.

You will first drive only your front wheels onto the scale pad, then drive ahead so that the whole vehicle is on the scale, then finally pull off until just the rear wheels are on the pad.

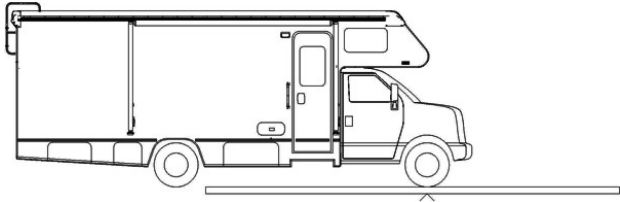

Front GAWR (Front Axle Only)

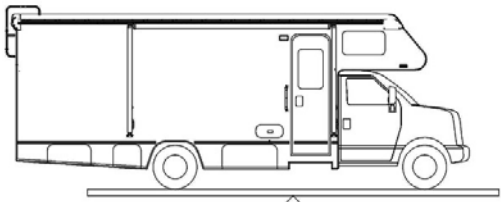

GVWR - Whole Vehicle (All Axles)

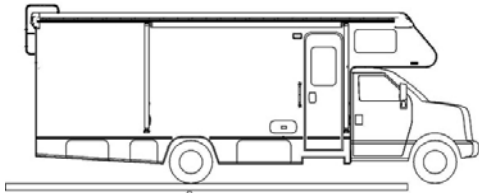

Rear GAWR (Rear Axle Only)

You will receive a weight “ticket” that states your current Front Gross Axle Weight, Rear Gross Axle Weight, and Gross Vehicle Weight. You can compare these weights to the weight ratings listed on your Vehicle Certification Label to use as a guideline for future loading limits and weight distribution.

The gross weight of the vehicle must not exceed the Gross Vehicle Weight Rating (GVWR) specified on the Vehicle Certification Label. The front and rear axle weight also should not exceed the corresponding Axle Weight Rating specified on the Vehicle Certification Label.

### Corner Weighing (Side-to-Side)

The most accurate method of weighing a motorhome is to weigh each “corner” of the coach separately (single L/R front wheels or L/R rear dual sets.) This method will help you determine how to distribute your cargo to avoid overloading, especially on tires.

To determine the weight distribution on each tire or dual set, you will need to find a scale capable weighing side-to-side, or all four “corners” of the vehicle separately.

A truck scale may be used if the ground is level with the scale surface and the scale has clearance to drive one side of the coach onto the scale as shown.

Drive the coach on the level area next to the scale and straddle the scale so that only one side of the coach will be on the scale pad.

*NOTE: Wind and precipitation can also cause weight inaccuracies.*

Pull only the right front wheel onto the scale pad as shown.



Weighing Right Front Corner

When the front wheel has been weighed, pull the coach straight ahead until only the right rear wheel/dual set is on the scale pad as shown.



Weighing Right Rear Corner

Now, turn the coach around and repeat the process for the other side.

The load on each wheel or dual-wheel set should not exceed one-half of the corresponding GAWR. For example, if the GAWR for the rear

axle is 12,000 lbs., then the load on each rear dual set (left rear duals or right rear duals) should not exceed 6,000 lbs.

Tires must be filled to the recommended air pressure for the highest loaded tire set on that axle. For example, on the rear axle, if the left side weighs more than the right, fill the left tires to the pressure required for that weight, then fill the right tires to the same pressure as the left ones.

If your actual weight is considerably less than GAWR, you may be able to lower your tire pressure. See a tire dealer for a load/pressure chart.

*NOTE: The Hitch Load from a Towed Vehicle or carrier box must also be counted on the Rear GAWR and subtracted from the rear axle cargo capacity.*

Be aware that hitch load can affect handling characteristics. The more weight on the hitch, the lighter the front end will feel at the steering wheel.

---



---

## CAR OR TRAILER TOWING

### Hitch Capacity\*

**5,000 lbs. max.**

### Tongue Weight\*

**500 lbs. max.**

The factory installed towing hitch on this coach is capable of pulling 5,000 lbs. load (max.), however, the vertical (tongue) weight may vary according to chassis and model combinations (\*see label on hitch). Towing capacity may be less than hitch rating.

When towing a trailer or vehicle, do not exceed either the GVWR, the rear axle GAWR, or the chassis GCWR by the combined loaded weight of the coach and the towed vehicle. *See preceding items “Loading the Vehicle” and “Weighing Your Loaded Vehicle” for explanation of weight ratings.*

Because of individual vehicle use and loading habits, we recommend weighing the vehicle while fully loaded to avoid exceeding any of the

listed Gross Weight Ratings. See “Vehicle Certification Label” in the Introduction section for information on gross weight ratings.

Towing will affect vehicle handling, durability, and fuel economy. Exceeding any of the listed Gross Weight Ratings will result in unacceptable overall vehicle performance. Maximum safety and satisfaction when towing depends on proper use of correct equipment.

When towing a vehicle behind your motorhome, the tow bar should be level or pointing slightly upward towards the tow vehicle.

When coupling the vehicle tow bar to the Factory Receiver Hitch using a “drop receiver” or a conventional “ball mount” (commonly referred to as a “stinger” or a “draw bar”), do not exceed a 4” drop, nor one that the centerline of the hitch pin to the centerline of the ball exceeds 8”. See the following Hitch Assembly illustration.

If a towing “brake system” is required, we recommend that a “modulated” towed vehicle braking device be installed. This means that when the motorhome brakes are applied, whether hard or soft, a mirror effect occurs in the braking of the towed vehicle. In other words, the more force applied to the motorhome brakes, the more force will be applied to the rear vehicle’s braking system.

We do not recommend the usage of a “surge-style” braking device. The usage of a surge brake (especially when coupled with a hitch ball located outside our recommended limits) places excessive stress on the hitch. This abuse of the ball mount and the hitch may cause premature hitch assembly failure.

Finally, do not forget to consider the actual tongue weight. This should not exceed the stated hitch vertical load for your vehicle. This weight is typically defined as the tongue weight of a towed vehicle hitch, boat trailer tongue weight, or a receiver-mounted carrier rack.

Check state regulations on trailer weight and trailer brake requirements to be sure you select the right equipment before towing.

Before descending a steep or long grade when towing a trailer, reduce speed and shift into a lower gear to control vehicle speed. Avoid prolonged or frequent application of brakes which could cause overheating and brake failure.

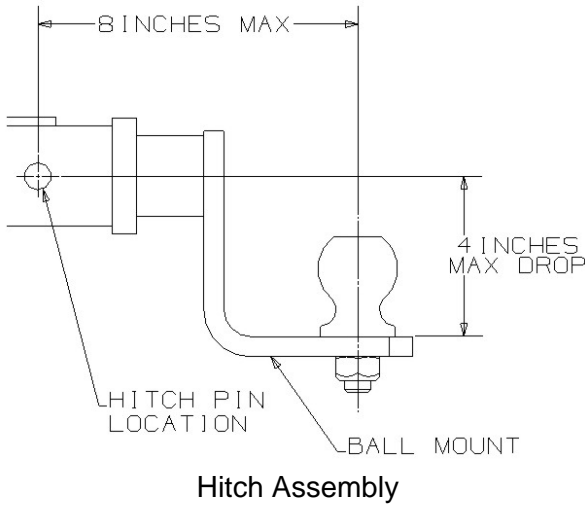

WARNING

For safe towing and vehicle handling, maintain proper trailer weight distribution. The total weight of the motorhome and the vehicle towed must not exceed the Gross Combined Vehicle Weight rating. See the “Body and Chassis Specification” chart in the Introduction section.

NOTICE

Exceeding any of the recommended gross vehicle weight ratings may result in vehicle damage. Do not install a frame equalizing-type hitch on your vehicle.

---



---

## TRAILER WIRING CONNECTOR

Your coach is pre-wired for trailer or car towing lights with a 7-pin socket.

The following diagram shows proper connection of trailer or tow vehicle wiring to the coach light system. The “pigtail” assembly with the (car/trailer end) connector plug should be wired by a qualified technician.

The trailer brake controller connector is located beneath the driver seat.

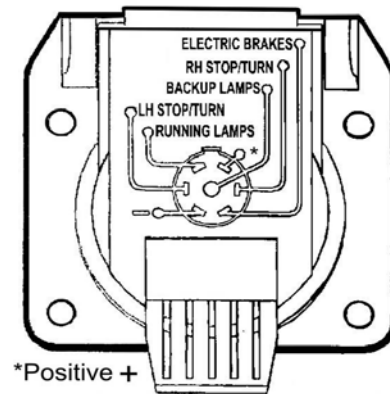

---



---

## TOWING GUIDELINES

### Gross Vehicle Weight Rating (GVWR)

This is the maximum allowable weight of the fully loaded vehicle. Included are fuel, water, LP, passengers, cargo, tools, and optional equipment installed by the motor home manufacturer, dealer, or owner. This value is found on the VIN label, typically placed near the driver position.

### Gross Axle Weight Rating (GAWR)

This is the total weight a given axle is capable of carrying, measured at the ground. Each axle has its own rating. These values are also found on the Vehicle Certification Label: front and rear.

### Gross Combination Weight Rating (GCWR)

This is the maximum allowable weight of the motor home and loaded trailer, including the items noted in GVWR above. For purposes of

this definition, the “trailer” can be a trailer, a vehicle towed on a dolly, or a vehicle towed by means of a tow bar. GCWR is typically specified based on durability and performance of the tow vehicle drive train: engine and cooling systems, transmission, drive line, drive axle, and others. The tow vehicle brakes may be rated for operation at GVWR, not GCWR.

*NOTE: State or provincial laws/regulations may require the “trailer” to be equipped with brakes that are activated when the motor home brakes are applied. **The user is responsible to know and understand the laws of the state or province being traveled.** The Department of Transportation in a given state or province should be able to provide specific information.*

**Hitch Ratings**

SAE Standard J684 defines:

- Class 1 trailers as “GVWR not to exceed 2,000 lbs”.
- Class 2 trailers as “GVWR over 2,000 lbs. and not to exceed 3,500 lbs. GVWR”.
- Class 3 trailers as “GVWR over 3,500 lbs. and not to exceed 5,000 lbs. GVWR”.
- Class 4 trailers as “GVWR over 5,000 lbs. and not to exceed 10,000 lbs. GVWR”.

Hitches are to be permanently marked with “Maximum trailer GVWR to be drawn” and “Maximum vertical tongue weight to be imposed.” The SAE standard does not specify a vertical load rating.

Traditionally, hitches are labeled 3,500/350 as Class 2, 5,000/500 as Class 3, and 10,000/1,000 as Class 4. The vertical tongue load value of 10 percent of drawn rating comes from the collective experience that 10 percent is the minimum value that provides stable towing of a trailer.

*NOTE: Some Winnebago Industries® models equipped with a Class 3 hitch may have a label limiting vertical tongue load to 350 lbs. All Winnebago Industries models equipped with a Class IV hitch have a*

*label limiting vertical tongue load to 500 lbs. On a 228" wheelbase, a 500-lb. load on a hitch 11' from the rear axle will apply about 800 lbs. at the axle.*

The user must verify that the hitch equipment being used is adequate for the application.

---



---

**ENTRY STEP – ELECTRIC  
–If Equipped**

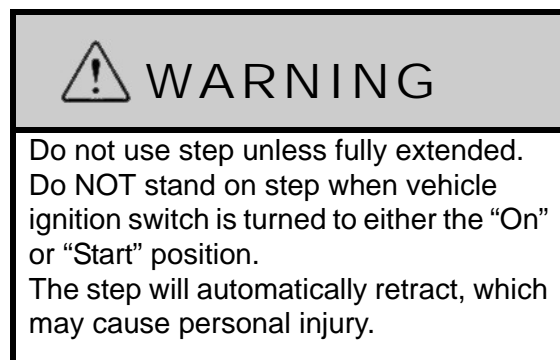

The power switch for the electric entry step is located to the left of the main entry door as you enter the coach.



**Entry Step Switch  
(Located near entrance door)  
-Typical View**

The step has several automatic extend/retract functions that are controlled by the position of a sensor mounted on the inner edge (hinge side) of the screen door.

**Automatic Mode - Entry Step  
Switch ON**

**(Step Operates with Door)**

With the Step switch in the ON position, the step is in Automatic Mode. This means it will extend and retract automatically whenever the screen door is opened or closed.



Red Activation Lever

- The red Activation Lever located on the entry step switch must be depressed in order to put the step switch in the ON position.

**Stationary Extended Mode - Step  
Switch OFF**

**(Step Remains Extended)**

With the Step power switch in the OFF position, the step will extend when the screen door is opened and will stay extended whether the door is opened or closed.

This position is normally used to keep the step extended when parked at a campsite or whenever people will be going in and out the vehicle frequently.

**Automatic Retraction Feature**

The step is equipped with an automatic retraction feature that stores the step automatically if the main entry door is closed and the Ignition Switch key is turned to the On or Run positions.

The step **WILL RETRACT** even if the Step switch is OFF.

This feature is intended to prevent injury or damage by an extended step while the vehicle is moving.

**Further Information**

For additional information on the step, see the manufacturer's operators manual included in your InfoCase.

---

---

**WINDOWS**

**Crank-Out Windows**

- Turn the crank-out handle from the horizontal position to the vertical position.



- Pull out the lever on the crank-out handle and begin cranking out the window counter-clockwise to desired position.

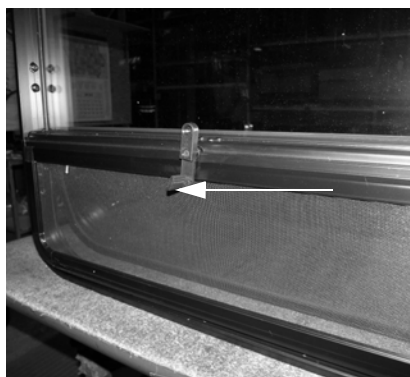

- To close, crank the window in snugly (by turning the crank-out handle clockwise), then back off 1/4 turn to help avoid glass warping, which can result in wind noise.
- Push the lever back in on the crank-out handle and lay back in the horizontal position.

If the window will not open after three or more full turns of the knob, the glass may be stuck to the sealing gasket. Go to the outside of the coach and gently free the glass with your fingers. A periodic light dusting of talcum powder on the gasket should prevent this from recurring.

**Horizontal Slider Windows**

Swing the latch handle straight out or up (depending on the style of window). Grasp the sliding window edge frame and slide the window to the side. Be sure the latch is open before trying to slide the window closed.



**Vertical Slider Windows**

Vertical windows have spring-loaded catches on both sides of the window that pop out to hold the window in its fully raised position. Press the catches outward toward the frames while lowering the window.



Vertical Window Catches  
-Typical View

**Push-Out Windows (Optional)  
-If Equipped**

The bedroom and lounge windows are secured by four safety latches at the sides and bottoms of each window.

To open window, release all four window latches and push open.

1. Side Latches (2) - Pull down toward bottom of window frame.
2. Bottom Latches (2) - Pull toward the left-hand side of the window frame.
3. Push window open.

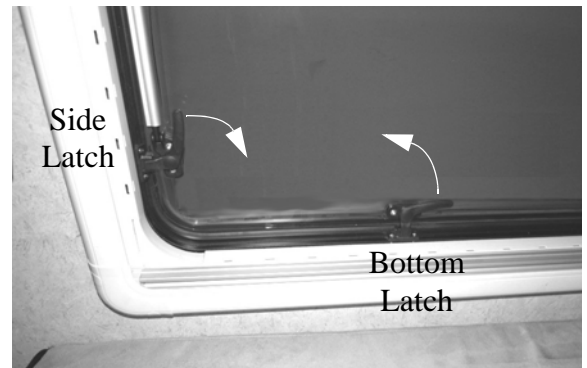

View of interior left-hand side of window  
-Typical View

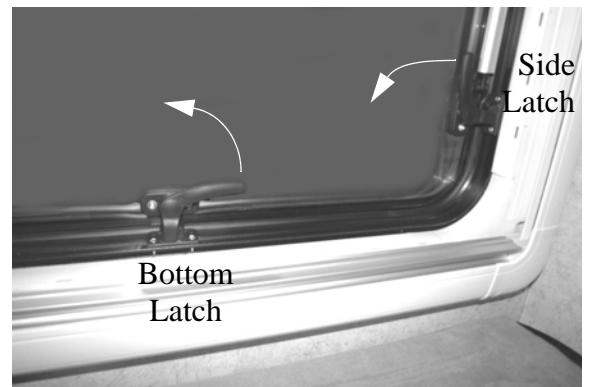

View of interior right-hand side of window  
-Typical View

**Propping the Windows Open**

The bedroom and lounge windows are featured with prop rods on each side of the window. These rods have three notches to prop your windows open at. Push window open slowly and stop at the preferred notch setting.

### Closing the Windows

To close window, extend all the way out (past the third notch setting) and the window will retract. Grab one of the window latches and pull window toward you and secure all four latches into locked position.

---

---

## POWER ROOF VENTILATOR

### Lounge, Galley, or Bath Area –If Equipped

The vent dome is raised and lowered using the Dome Crank knob on the fan.

The turbine fan will start automatically as the vent is raised, and stop as the vent is lowered.

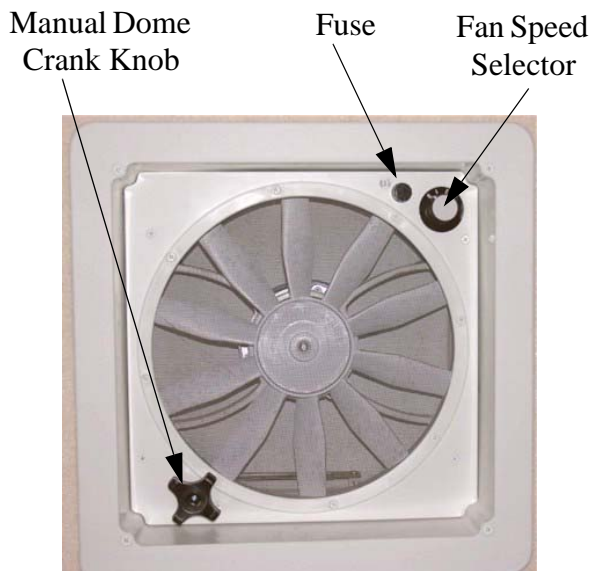

Power Roof Ventilator

### To Operate Ceiling Ventilator

1. Turn the Dome Crank Knob to raise the dome about 3" or more to allow the turbine fan to operate. (*A built-in safety switch will not let the fan motor run unless the dome is partially open.*)
2. The turbine fan will start automatically as the vent dome is raised and stop as the vent dome is lowered and closed. (*Fan Power switch must be ON and Fan Speed knob in a position other than 0-Off.*)
3. Turn the Fan Speed knob to the desired level (0-Off, 1-Low, 2-Med, 3-Hi).

4. Open a window or door to provide airflow. Direction of airflow is determined by which window or door is opened.

*NOTE: For best results, close all other roof vents, windows, and doors, then open one (1) window the farthest distance from the roof ventilator. The fan speed selector on the fan allows you to adjust the amount of circulation you need at any time.*

5. If you want the vent dome raised without the fan running, turn Off either the Fan Power switch or Fan Speed knob (0-Off).

### Further Information

See the power ventilator manufacturer's operating instructions supplied in your InfoCase for further instructions, care, and cleaning information.

---

---

## STORAGE COMPARTMENT DOORS

The high-density gaskets used on the exterior storage compartments are designed to provide a more positive seal against dust and weather. Sometimes this seal firmness can inhibit complete latching of the compartment doors if they are simply "dropped shut" or closing force is applied only to the center of the door.

To ensure that exterior storage compartment doors have latched properly, press firmly on the bottom edges (side edges - if equipped) of the doors with the palms of your hands. If the door is ajar you will hear and feel a loud "click" when the latches engage properly.

---

---

## POWER AWNING

### –If Equipped

The Power Awning switch is located near the entrance door.



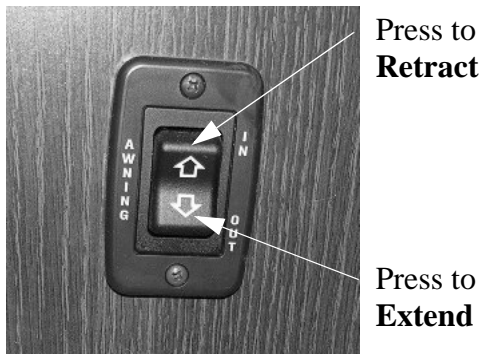

Power Awning Switch  
(Located near entrance door)  
-Typical View

## Operating the Awning

- Press and Hold the Power Awning switch until the awning is in the desired position, then release.

## Ignition Lockout System

The Ignition Lockout System will disable the extend function while the vehicle ignition key is in the On position. With this feature, the Awning will only extend when the vehicle ignition key is in the Off position. The Awning can retract anytime regardless of the ignition key position.

## Further Information

For complete operating instructions, features, safety precautions, and maintenance care, refer to the Power Awning manufacturer's information provided in your InfoCase.

---



---

## EFFECTS OF PROLONGED OCCUPANCY

Your motorhome was designed primarily for recreational use and short-term occupancy. If you expect to occupy your coach for an extended period, be prepared to deal with condensation and humid conditions that may be encountered.

## Humidity and Condensation

Moisture condensing on the inside of windows is a visible indication that there is too much humidity inside the coach. Excessive

moisture can cause water stains or mildew, which can damage interior items such as upholstery and cabinets.

When you recognize the signs of excessive moisture and condensation in your coach, you should take immediate action to minimize their effects.

You can help reduce excessive moisture inside the motorhome by taking the following steps:

### Ventilate with outside air

Partially open one or more windows and a roof vent to circulate outside air through the coach. In cold weather, this ventilation may increase use of the furnace, but it will greatly reduce the condensation inside the coach.

### Minimize moisture released inside the coach

Run the range hood fan while cooking and open a bath vent while bathing or showering to carry water vapor out of the coach. Avoid making steam from boiling water excessively or letting hot water run. Avoid bringing extra moisture into the coach by way of soaked clothing or snow on shoes. Do not hang-dry wet overcoats or clothing inside the coach.





## INDEX

---

About this Manual .....	1-1	Engine Cooling System .....	3-10
Air Conditioner Filter .....	4-9	Engine Overheat .....	2-10
Air Conditioner/Heater – Automotive (Dash) .....	3-5	Entry Step – Electric .....	12-5
Audio-Video System Basic Operation .....	8-1	Exterior Automotive Paint Finish .....	11-2
Bathroom .....	11-9	Exterior Graphic Care .....	11-4
Battery Access .....	6-9	Exterior Lights .....	11-5
Battery Boost Switch .....	3-10	Exterior Shower/Wash Station .....	7-7
Battery Care .....	6-10	External Power Cord .....	6-1
Bed Extension .....	9-2	Fire Extinguisher .....	2-5
Cabinetry – Cleaning .....	11-7	Flex Bed .....	9-2
Cable TV and Satellite Connections .....	8-4	Formaldehyde Information .....	2-7
Car or Trailer Towing .....	12-3	Fresh Water System .....	7-1
Carbon Monoxide Alarm .....	2-4	Front Axle Tire Alignment .....	1-2
Carbon Monoxide Warning .....	2-3	Front Bunk .....	9-1
Chassis Service and Maintenance .....	11-11	Fuel and Propane Gas .....	2-1
Circuit Breakers – House 120-Volt AC .....	6-5	Fuel Fill Access .....	3-10
Circuit Breakers and Fuses – House 12-Volt DC .....	6-11	Galley Sink .....	11-8
Coach Maintenance Chart .....	11-12	General Slideout Care .....	10-8
Cold Water Filter .....	7-4	General Warnings .....	2-1
Comfort Sofa Sleeper .....	9-3	Ground Fault Circuit Interrupter .....	6-5
Diesel Exhaust Fluid Fill .....	3-11	Hazard Warning Flashers .....	3-5
Dinette Conversion .....	9-6	Heat Pump .....	4-8
Dinette/Bed Conversion .....	9-5	Holding Tank Heater .....	7-11
Disinfecting Your Fresh Water System .....	7-6	House/Coach Battery Disconnect Switch ....	6-8
Doors and Windows .....	11-9	Infotainment Center/GPS .....	3-8
Drainage System (P-Traps) .....	7-7	Interior Soft Goods .....	11-5
Driving Safety .....	2-1	Inverter Unit – 1000W .....	6-3
Ducted Roof Air Conditioning System .....	4-9	Jump Starting .....	2-10
DVD Player with Deluxe Sound .....	8-2	Keys .....	3-4
Effects of Prolonged Occupancy .....	12-9	Lights .....	3-11
Electrical .....	2-5	Loading .....	2-5
Electrical Cautions .....	6-1	Loading the Vehicle .....	12-1
Electrical Generator – 120-Volt .....	6-6	Maintenance .....	2-6
Electrical Outlets – House 120-Volt AC ....	6-5	Microwave Oven .....	4-3
Electrical System – House 120-Volt AC ....	6-1	Mirrors – Power Electric .....	3-4
Electrical System – House 12-Volt DC .....	6-8	Mold, Moisture, and Your Motor Home .....	2-8
Emergency Exits .....	2-6	Occupant and Cargo Carrying Capacity Label .....	1-3
		OnePlace® Systems Monitor Panel .....	4-4

---

---

Owner and Vehicle Information .....	1-6	Slideout Room Troubleshooting	
Plastic Parts – Cleaning .....	11-4	(Power Gear®) .....	10-4
Power Awning .....	12-8	Slideout Rooms .....	2-7
Power Center .....	6-4	Smoke Alarm .....	2-4
Power Roof Ventilator .....	12-8	Specifications and Capacities .....	1-5
Power Sunvisor .....	3-5	Stainless Steel Appliances .....	11-7
Pre-Delivery Inspection .....	1-2	Storage Compartment Doors .....	12-8
Pressure-Temperature Relief Valve .....	4-6	Suspension Alignment and Tire Balance ...	3-14
Propane Gas Furnace .....	4-7	Tables and Countertops .....	11-7
Propane Gas Leak Detector .....	2-3	Tires .....	3-13
Propane Gas Leaks .....	2-2	Toilet .....	7-7
Propane Gas Pressure Regulator .....	5-4	Towing Guidelines .....	12-4
Propane Gas Supply .....	5-1	Trailer Wiring Connector .....	12-4
Propane Gas Warnings and Precautions .....	5-4	TV – 12V LED .....	8-1
Propane Vaporization in Cold Weather .....	5-5	TV – Pull out .....	8-1
Radio In-Dash/Rearview Monitor System ...	3-6	TV Antenna - Digital .....	8-3
Range and Refrigerator .....	11-8	TV Digital Satellite System – Manual .....	8-4
Range Hood .....	4-4	TV Digital Satellite System Wiring .....	8-5
Range Top .....	4-2	TV Signal Amplifier .....	8-3
Refrigerator .....	4-1	Undercarriage .....	11-1
Refrigerator Service Access Compartment ..	4-2	Valve Stem Access .....	3-12
Remote Keyless Entry .....	3-4	Vehicle Certification Label .....	1-4
Reporting Safety Defects .....	1-2	Vehicle Storage – Preparation .....	11-9
Roadside Emergency .....	2-8	Vehicle Storage – Removal .....	11-10
Roller Shades (Manual) - Solar Day/Night ..	9-8	Vinyl Flooring .....	11-8
Roof .....	11-1	Waste Water System - Model 25R .....	7-7
Safe Use of the Propane Gas System .....	5-3	Waste Water System (Waste Pump) -	
Safety Messages Used in this Manual .....	1-1	Models 25T & 25Q .....	7-9
Sealants – Inspection and		Water Heater - Gas/ Electric .....	4-6
General Information .....	11-1	Water Heater Bypass and Antifreeze	
Seat Belts .....	3-2	Siphon Valves .....	7-12
Seats – Driver/Co-Pilot (Chassis Supplied) .	3-1	Water Pump .....	7-3
Seats – Driver/Co-Pilot (Flexsteel) .....	3-1	Water System Drain Valve Locations .....	7-19
Service and Assistance .....	1-2	WaterLine and Tank Drain Valves .....	7-11
Shower Hose Vacuum Breaker .....	7-6	Weighing Your Loaded Vehicle .....	12-1
Sleeping Facilities .....	9-1	Wheel Mounting Nuts (Lug Nuts) .....	2-10
Slideout Emergency Retraction		Window Shades/Screens .....	9-7
(Power Gear®) .....	10-6	Windows .....	12-6
Slideout Room – Extreme		Winterizing Procedures .....	7-12
Weather Precaution .....	10-4	Wood Furniture and Cabinetry .....	9-8
Slideout Room Operation – Electric .....	10-2		
Slideout Room Travel Lock .....	10-1		

---